



**XSA1000 Series Spectrum Analyzer**  
**Quick Guide**

[www.owon.com.cn](http://www.owon.com.cn)



7007020100049

## **June 2017 edition V1.0.0**

Copyright © LILLIPUT Company. All rights reserved.

The LILLIPUT's products are under the protection of the patent rights, including ones which have already obtained the patent rights and those which are applied for. The information in this manual will replace all materials published.

The information in this manual was correct at the time of printing. However, LILLIPUT will continue to improve products and reserves the rights to change specification at any time without notice.

**owon**<sup>®</sup> is the registered trademark of the LILLIPUT Company.

### **Fujian LILLIPUT Optoelectronics Technology Co., Ltd.**

No. 19, Heming Road

Lantian Industrial Zone, Zhangzhou 363005 P.R. China

**Tel:** +86-596-2130430

**Fax:** +86-596-2109272

**Web:** [www.owon.com.cn](http://www.owon.com.cn)

**E-mail:** [info@owon.com.cn](mailto:info@owon.com.cn)

# General Warranty

OWON warrants that the product will be free from defects in materials and workmanship for a period of 3 years from the date of purchase of the product by the original purchaser from the OWON Company. The warranty period for accessories is 12 months. This warranty only applies to the original purchaser and is not transferable to a third party.

If the product proves defective during the warranty period, OWON will either repair the defective product without charge for parts and labour, or will provide a replacement in exchange for the defective product. Parts, modules and replacement products used by OWON for warranty work may be new or reconditioned like new. All replaced parts, modules and products become the property of OWON.

To obtain service under this warranty, the customer must notify OWON of the defect before the expiration of the warranty period. Customer shall be responsible for packaging and shipping the defective product to OWON's designated service centre, a copy of the customer's proof of purchase is also required.

This warranty shall not apply to any defect, failure or damage caused by improper use or improper or inadequate maintenance and care. OWON shall not be obligated to furnish service under this warranty a) to repair damage resulting from attempts by personnel other than OWON representatives to install, repair or service the product; b) to repair damage resulting from improper use or connection to incompatible equipment; c) to repair any damage or malfunction caused by the use of non-OWON supplies; or d) to service a product that has been modified or integrated with other products when the effect of such modification or integration increases the time or difficulty of servicing the product.

Please contact the nearest OWON's Sales and Service Offices for services or a complete copy of the warranty statement.

For better after-sales service, please visit [www.owon.com.cn](http://www.owon.com.cn) and register the purchased product online.

**Excepting the after-sales services provided in this summary or the applicable warranty statements, OWON will not offer any guarantee for maintenance definitely declared or hinted, including but not limited to the implied guarantee for marketability and special-purpose acceptability. OWON should not take any responsibilities for any indirect, special or consequent damages.**

# Table of Contents

<b>1. General Safety Requirements</b> .....	<b>1</b>
<b>2. Safety Terms and Symbols</b> .....	<b>3</b>
<b>3. User Notice</b> .....	<b>4</b>
<b>3.1 General Inspection</b> .....	<b>4</b>
<b>3.2 Safety Precaution before Operation</b> .....	<b>4</b>
3.2.1 Check Power Supply .....	4
3.2.2 Allowed Variation Range of Supply Power Parameters .....	5
3.2.3 Power Cord Selection .....	5
3.2.4 Electro-static Discharge (ESD) Protection .....	6
<b>3.3 First Time to Power on</b> .....	<b>6</b>
<b>4. Quick Start</b> .....	<b>8</b>
<b>4.1 Front Panel</b> .....	<b>8</b>
4.1.1 Front Panel Function Key .....	9
4.1.2 Parameter Input .....	11
4.1.3 Front Panel Connector .....	13
<b>4.2 Rear Panel</b> .....	<b>14</b>
<b>4.3 User Interface</b> .....	<b>16</b>
<b>4.4 Build-in Help</b> .....	<b>17</b>
<b>4.5 Basic Measurement</b> .....	<b>19</b>
<b>5. Troubleshooting</b> .....	<b>21</b>
<b>6. Appendix</b> .....	<b>23</b>
<b>Appendix A: Enclosure</b> .....	<b>23</b>
<b>Appendix B: General Care and Cleaning</b> .....	<b>23</b>
<b>Appendix C: USB Disk Requirements</b> .....	<b>23</b>

# 1. General Safety Requirements

**Before use, please read the following safety precautions to avoid any possible bodily injury and to prevent this product or any other connected products from damage. To avoid any contingent danger, ensure this product is only used within the ranges specified.**

- **Use Proper Power Cord.** Use only the power cord supplied with the product and certified to use in your country.
- **Product Grounded.** This instrument is grounded through the power cord grounding conductor. To avoid electric shock, the grounding conductor must be grounded. The product must be grounded properly before any connection with its input or output terminals.
- **Check all Terminal Ratings.** To avoid fire or shock hazard, check all ratings and markings on this product. Refer to the user manual for more information about ratings before connecting to the instrument.
- **Use Proper Overvoltage Protection.** Make sure that no overvoltage (such as that caused by a thunderstorm) can reach the product, or else the operator might expose to danger of electrical shock.
- **Do not operate without covers.** Do not operate the instrument with covers or panels removed.
- **Avoid exposed circuit.** Be careful when working on exposed circuitry to avoid risk of electric shock or other injury.
- **Do not operate if any damage.** If you suspect damage to the instrument, have it inspected by qualified service personnel before further use. Any maintenance, adjustment or replacement especially to circuits or accessories must be performed by qualified service personnel.
- **Use your Oscilloscope in a well-ventilated area.** Make sure the instrument installed with proper ventilation.
- **Do not operate in damp conditions.** In order to avoid short circuiting to the interior of the device or electric shock, please do not operate in a humid environment.

## 1. General Safety Requirements

---

- **Do not operate in an explosive atmosphere.** In order to avoid damages to the device or personal injuries, it is important to operate the device away from an explosive atmosphere.
- **Keep product surfaces clean and dry.** To avoid the influence of dust or moisture in air, please keep the surface of device clean and dry.
- **Electrostatic Prevention.** Operate the instrument in an electrostatic discharge protective environment to avoid damage induced by static discharges. Always ground both the internal and external conductors of cables to release static before making connections.
- **Protect the Input Terminals of Instrument.** Do not bend or hit the input terminals and the connected devices, (such as filter, attenuator, etc.) as such stress may cause damages to devices and the instrument. Do not mix the use of 50 $\Omega$  and 75 $\Omega$  connectors and/or cables.
- **Do Not Overload the Input.** To avoid damaging the instrument, the signals at input terminal must be less than 50V DC voltage components and 30 dBm (1 W) AC (RF) components.
- **Appropriate Use of Power Meter.** If you are not sure of the characteristics of signal under measure, follow these recommendations to ensure safe operations: if a RF power meter is available, use it to measure the power level of this signal first; or add a rated external attenuator between signal cable and input terminal of the instrument. Maximum attenuation, reference level and maximum span frequency should be selected, so as to make the signals displayed within the screen.
- **Know About the Specification Conditions of the Instrument.** For maximum performance of the instrument, use the analyzer under specified conditions.
- **Handling Safety.** Please handle with care during transportation to avoid damages to buttons, knob, interfaces and other parts on the panels.

## 2. Safety Terms and Symbols

### Safety Terms

**Terms in this manual** (The following terms may appear in this manual):



---

**WARNING**

Warning indicates conditions or practices that could result in injury or loss of life.

---



---

**CAUTION**

Caution indicates the conditions or practices that could result in damage to this product or other property.

---

**Terms on the product** (The following terms may appear on this product):

**DANGER** Indicates an immediate hazard or injury possibility.

**WARNING** Indicates a possible hazard or injury.

**CAUTION** Indicates potential damage to the instrument or other property.

### Safety Symbols

**Symbols on the product** (The following symbols may appear on the product):



Hazardous  
Voltage



Chassis  
Ground



Refer to  
Manual

### 3. User Notice

This chapter helps you in preparing the spectrum analyzer for use and provides the information to start using the spectrum analyzer correctly.

#### 3.1 General Inspection

When you receive your new instrument, it is recommended that you check the instrument following these steps:

##### 1. Check for transportation damage.

If it is found that the packaging carton or the foamed plastic protection cushion has suffered serious damage, do not throw it away until the complete device and its accessories have been electrically and mechanically checked.

##### 2. Check the Accessories

The supplied accessories are described in the "*Appendix A: Enclosure*" of this Manual. Please ensure that all the listed accessories are present and undamaged, if any problems are found please contact your distributor or OWON's local office.

##### 3. Check the Complete Instrument

If there is any physical damage, operational fault, or performance issue please contact your distributor or OWON's local office. If there is any damage to the instrument please ensure you keep the original packaging. Ideally you should always keep the original packaging if the instrument must be returned for repair.

#### 3.2 Safety Precaution before Operation

##### 3.2.1 Check Power Supply

The analyzer is equipped with a three-wire power cord in accordance with international safety standards. The product must be grounded properly before being powered on, as floating or improper ground may cause damage to the instrument or personal injury.

Make sure the grounding conductor of the spectrum analyzer is grounded before turning on the instrument. After which the AC power cord can be connected. Do not use a non-ground power cord.



### 3.2.2 Allowed Variation Range of Supply Power Parameters

XSA1000 series radio frequency spectrum analyzer is compatible with 100V~240V、50Hz-60Hz AC power, Table 3-1 lists the power requirement to run the spectrum analyzer.

Table 3-1 Working Power Variation Range

Power Supply Parameter	Compatible Range
Voltage	100 - 240 VAC
Frequency	50 - 60 Hz $\pm 10\%$
Power	22 W

To prevent or lower the risk of damage to the spectrum analyzer from power interference between instruments, especially from peak pulses produced by large power consumption instruments, a 220V/110V AC regulated power supply is recommended.

### 3.2.3 Power Cord Selection

The analyzer is equipped with a three-wire power cord in accordance with international safety standards. This cable grounds the analyzer cabinet when connected to an appropriate power line outlet. The cable must be rated greater than 250Vac and 2A.



#### **WARNING**

Improper grounding may cause damage to the instrument, or result in personal injury. Make sure the grounding conductor of the spectrum analyzer is grounded before turning on the instrument.

Always use a well-grounded power source. Do not use an external power cable, power cord or an auto transformer without grounded protection. If this product is to be powered via an external auto transformer for voltage reduction, ensure that its common terminal is connected to a neutral (earthed pole) of the power supply.

---



### **WARNING**

Make sure the supply power is stable before turning on the analyzer to protect it from damage. Refer to “First Time to Power on” section 3.

---

### 3.2.4 Electro-static Discharge (ESD) Protection

ESD is an issue often ignored by users. Damage from ESD on the instrument is unlikely to occur immediately but will significantly reduce the reliability of it. Therefore, ESD precautions should be implemented in the work environment, and applied daily.

Generally, there are two steps to manage ESD protection:

- 1) Conductive table mats to connect hands via wrist bands
- 2) Conductive ground mat to connect feet via ankle straps

Implement both protection methods will provide a good level of anti-static protection. If used alone, the protection will not be as reliable. To ensure user's safety, anti-static components should offer at least 1MΩ isolation resistance.



### **WARNING**

The above ESD protections measures cannot be used when working with over 500V!

---

Make good use of anti-static technology to protect components from damage:

- 1) Quickly ground the internal and external conductor of the coaxial cable before it is connected with the spectrum analyzer.
- 2) Staff must wear anti-static gloves before touching the connector cord or doing any assemble work.
- 3) Assure all the instruments are grounded properly to avoid static storage.

## 3.3 First Time to Power on

Connect the three-pin AC power cord into the instrument. Insert the plug into a power socket provided with a protective ground.

### 3. User Notice

---



#### **WARNING**

Check the power source before turning on the spectrum analyzer, to protect the device from damage.

---

- 1) Press the power switch  on the bottom left of the front panel.
- 2) Self-initialization takes about 30 seconds, after the boot screen the spectrum analyzer will default to the scanning curve.
- 3) After power on, let the spectrum analyzer warm up for 30 minutes for stabilization to obtain the most accurate results.

## 4. Quick Start

This chapter introduces the front / rear panel, the user interface and explains how to use the instrument with a measurement example demonstration.

### 4.1 Front Panel

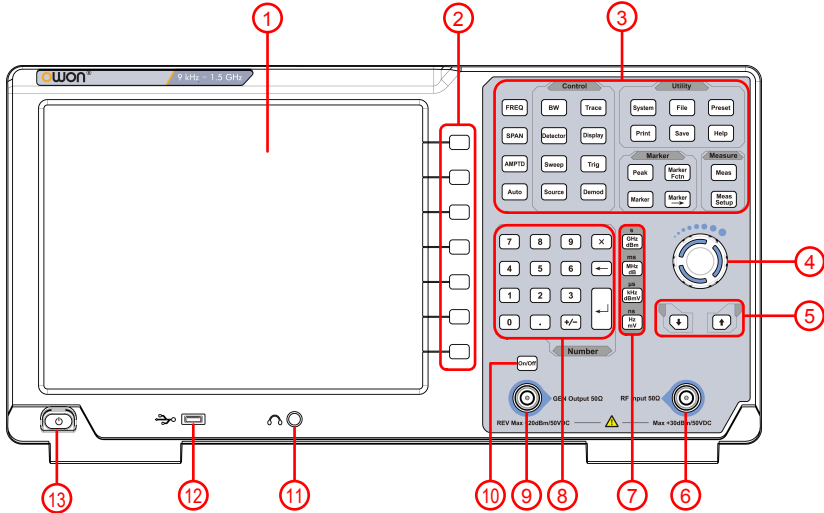

Figure 4-1 Front panel

NO.	Description	NO.	Description
①	LCD	⑧	Numeric keypad
②	Menu softkeys	⑨	Tracking generator output connector
③	Function keys	⑩	Tracking generator output On/Off button
④	Knob	⑪	Earphone interface
⑤	Arrow keys	⑫	USB Host port
⑥	RF Input connector	⑬	Power key (Push to turn on, long push to turn off)
⑦	Unit keys		

4.1.1 Front Panel Function Key

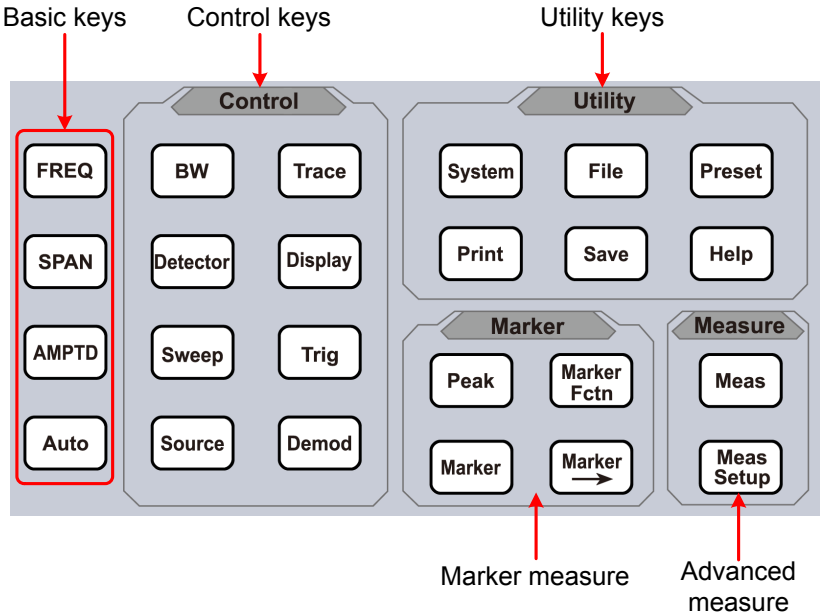

Figure 4-2 Function Keys

Keys	Description
<b>Basic keys</b>	
<b>FREQ</b>	Activates the center-frequency function, and accesses the frequency function menu.
<b>SPAN</b>	Activates the frequency sweep span function, and set Full Span\Zero Span>Last Span.
<b>AMPTD</b>	Activates the reference level function, and accesses the amplitude softkeys, with which you set functions that affect data on the vertical axis.
<b>AUTO</b>	Searches the signal automatically within the full frequency range.
<b>Control keys</b>	

## 4.Quick Start

<b>BW</b>	Activates the RBW (resolution bandwidth) function, and accesses the softkeys that control the bandwidth functions and averaging.
<b>Trace</b>	Accesses the softkeys that allow you to store and manipulate trace information.
<b>Detector</b>	Accesses the softkeys that allow you to configure detector functions.
<b>Display</b>	Accesses the softkeys that allow you to control what is displayed on the analyzer, including the display line, graticule and label.
<b>Sweep</b>	Accesses the softkeys that allow you to set the sweep time, select the sweep mode of the analyzer.
<b>Trig</b>	Accesses the softkeys that allow you to select the trigger mode of the analyzer.
<b>Source</b>	Accesses the softkeys that allow you to set the tracking generator.
<b>Demod</b>	Accesses the softkeys that allow you to set the demodulation.
<b>Marker measure keys</b>	
<b>Peak</b>	Places a marker on the highest peak, and accesses the Peak functions menu.
<b>Marker</b>	Accesses the marker control keys that select the type and number of markers and turns them on and off.
<b>Marker</b> →	Accesses the marker function softkeys that allow you to set other system parameters based on the current marker value.
<b>Marker Fctn</b>	Accesses the menu of special functions, such as noise marker, N dB bandwidth measure and frequency counting.
<b>Advanced measure keys</b>	

## 4.Quick Start

<b>Meas</b>	Accesses the softkeys that let you make transmitter power measurements such as ACPR(adjacent channel power), channel power, and OBW(occupied bandwidth), etc.
<b>Meas Setup</b>	Sets the parameters for the selected measurement function.
<b>Utility keys</b>	
<b>System</b>	Sets the system parameters, and accesses the calibration menu.
<b>File</b>	Accesses the softkeys that allow you to configure the file system of the analyzer.
<b>Preset</b>	Resets the analyzer to the factory settings or user state. This state can be specified in <b>【System】</b> → [PowerOn/Preset▶]→ [Preset▶].
<b>Print</b>	Accesses the softkeys that allow you to set the print parameters.
<b>Save</b>	Accesses the softkeys that allow you to save current screen, trace data, or user state.
<b>Help</b>	Press the Help key to activate the help system. Press the Help key again to exit.

### 4.1.2 Parameter Input

Specific parameter values are able to be entered using the numerical keyboard, knob, and directional keys.

#### **Numeric Keyboard**

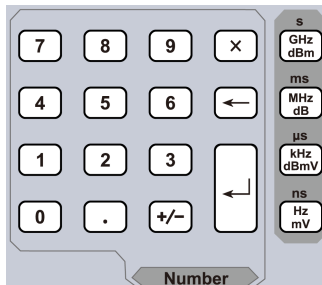





Figure 4-3 Numeric Keyboard

## 4.Quick Start

---

1. Numerical keys  
Numbers 0-9 are available to be used.
2.  Decimal point  
A decimal point “.” will be inserted at the cursor position when this key is pressed.
3.  Sign key  
Sign key “+/-” is to toggle the sign of a parameter. When pressed the first time, a “-” will be inserted and changed into “+” following the second press.
4. Unit keys  
Unit keys include GHz/dBm/s, MHz/dB/ms, kHz/dBmV/ $\mu$ s and Hz/mV/ns. After entering the desired numbers, choose an appropriate unit to complete the input. The specific meaning of unit is decided by the type of input parameter (“frequency”, “amplitude” or “time”).
5.  Cancel Key
  - (1) During the editing process this key will clear the inputs in the active area and exit editing mode at the same time.
  - (2) Turn off the display in the active area.
  - (3) Exit current test mode while in keyboard test.
6.  Back Key
  - (1) During the process of parameter editing, this key will delete the characters on the left side of the cursor.
  - (2) While in the process of file name editing, pressing this key will delete characters that have been entered.
7. Enter  
When pressed, the system will complete the input process and insert a default measurement unit for the parameter automatically.

### Knob



Figure 4-4 The knob

The knob function:

During parameter editing, turn the knob clockwise to increase, or counterclockwise to decrease the parameter values at specified



## 4.Quick Start

---

steps.

### Direction key



Figure 4-5 Direction keys

The directional keys have following functions:

- 1) Increase or decrease the parameter value at specific steps while editing a parameter.
- 2) Move the cursor through the directory tree in the **【File】** function.

### 4.1.3 Front Panel Connector

#### 1、USB Host



The analyzer may serve as a “host” device to connect to external USB devices. This interface is available for USB storage devices.

#### 2、GEN Output 50Ω (tracking generator output 50Ω)

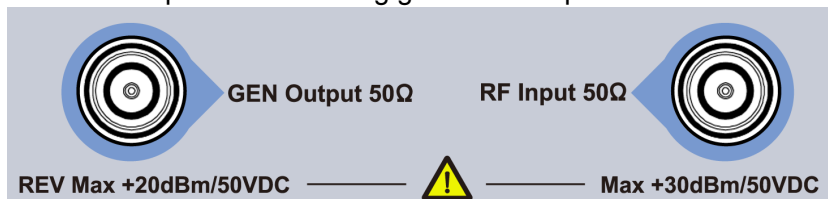

The output of the tracking generator can be connected to a receiver through an N type male connector, users can purchase this option if required.



#### **CAUTION**

Input voltage at RF input port must not be higher than 50 V DC to avoid damage to the attenuator and input mixer tracking generator.

---

#### 3、RF Input 50Ω

The RF input may be connected to a device via a N type connector



#### **CAUTION**

When input attenuator is higher than 10 dB, the RF port input signal must be less than +30 dBm.

---

## 4.2 Rear Panel

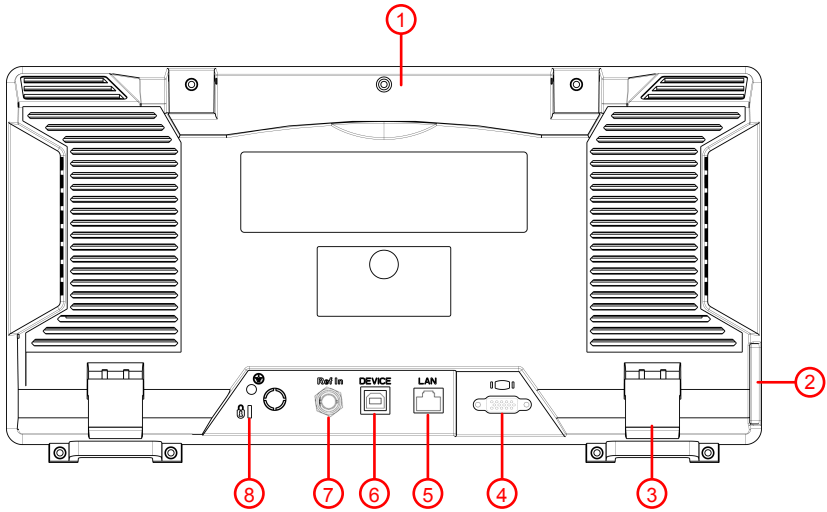

Figure 4-6 Rear Panel

## 4.Quick Start

<b>NO.</b>	<b>Name</b>	<b>Description</b>
①	Handle	Stow the handle for mobile use.
②	AC power connector	AC: frequency 50Hz±10%,single-phase alternative 220V±15% or 110V±15%
③	Stool	To adjust the angle of the device
④	VGA port	provides a VGA signal output which is used through a VGA cable or with a projector
⑤	LAN interface	Through this interface, the analyzer can be connected to your local network for remote control. An integrated testing system can be built quickly, as the analyzer conforms to the LXI C Device class instrument standards.
⑥	USB Device interface	This configurable USB port permits external USB devices. It supports PictBridge printer and remote-control connection.
⑦	10MHz IN/OUT	The BNC input or output of the 10 MHz reference clock
⑧	Lock hole	You can lock the spectrum analyzer to a fixed location using the security lock (please buy it yourself) to secure the spectrum analyzer.

### 4.3 User Interface

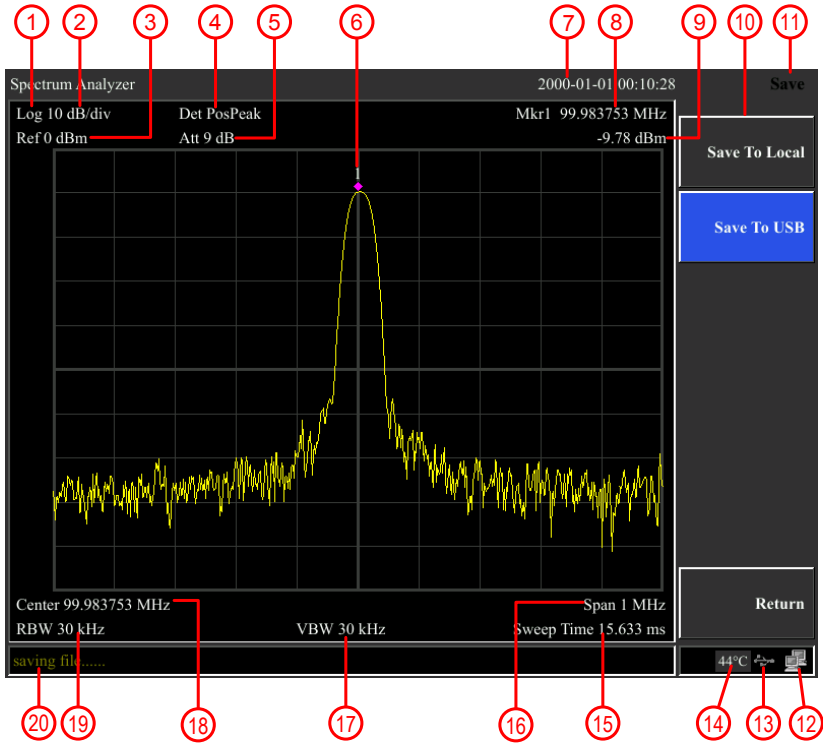

Figure 4-7 User interface

Table 4-1 User interface

NO.	Name	Description	Related Key
①	Amplitude Division Type	Can choose logarithmic or linear	【AMPTD】 → [Scale Type]
②	Amplitude Division	Display division scale	【AMPTD】 → [Scale/Div]
③	Reference level	Reference level	【AMPTD】 → [Ref Level]
④	Detection type	Display detection type	【Detector】
⑤	Attenuation	Display input attenuation setting	【AMPTD】 → [Attenuation]
⑥	Marker	Display current activated marker	【Marker】

## 4.Quick Start

⑦	Date/time	Display system date and time	【System】 → [Date/Time]
⑧⑨	Marker readout	Display frequency and amplitude of current marker	【Marker】
⑩	Menu item	Menu item of current function	
⑪	Menu title	Function of current menu belongs to.	
⑫	LAN access sign	LAN access sign	
⑬	USB storage device	Show if USB storage device is inserted;	
⑭	Temperature sign	Display device internal temperature	
⑮	Sweep Time	System sweep time	【Sweep】 → [Sweep Time]
⑯	Span	Display span width	【SPAN】 → [Span]
⑰	Video bandwidth	Display video bandwidth	【BW】 → [VBW]
⑱	Center frequency	Display center frequency	【FREQ】 → [Center Freq]
⑲	Resolution bandwidth	Display resolution bandwidth	【BW】 → [RBW]
⑳	System status	Display spectrum analyzer status	

## 4.4 Build-in Help

The built-in help provides information that refers to every function key and menu key on the front panel. Users can view this help information if required

### 1.How to acquire built-in help

Press Help; a prompt about how to obtain help information will be shown

### 2.Page up and down

If there is more than one page of information, you can read the complete information by using the directional keys.

### **3.Close the current help information**

Press “Help” again to close help.

### **4.Acquire the menu help**

A message about how to obtain help information will be shown, press the menu keys to get the corresponding help.

### **5.Acquire the help information of any function key**

A message about how to obtain help information will be shown, press any function key to get the corresponding help.

### 4.5 Basic Measurement

Basic measurements include, input signal frequency and amplitude display, marked by a frequency marker. Follow these four simple steps below to implement input signal measurement.

Basic:

1. Set the center frequency;
2. Setup span and resolution bandwidth;
3. Activate the marker;
4. Setup amplitude;

For example, to measure a 100MHz -20dBm signal you must turn on the spectrum analyzer and ensure it is warmed up for 30 minutes to ensure measurement accuracy.

1. Equipment connection:

Connect the signal generator to the spectrum analyzer input terminal and set the parameters as follows:

Frequency	100 MHz
Amplitude	-20 dBm

2. Setup parameters:

- 1) Press “Preset” to reset the spectrum analyzer to factory settings. The Spectrum analyzer will display the spectrum from 9kHz to the maximum span width. The signal generated will display as a vertical line at 100MHz. Refer to Figure 4-8.

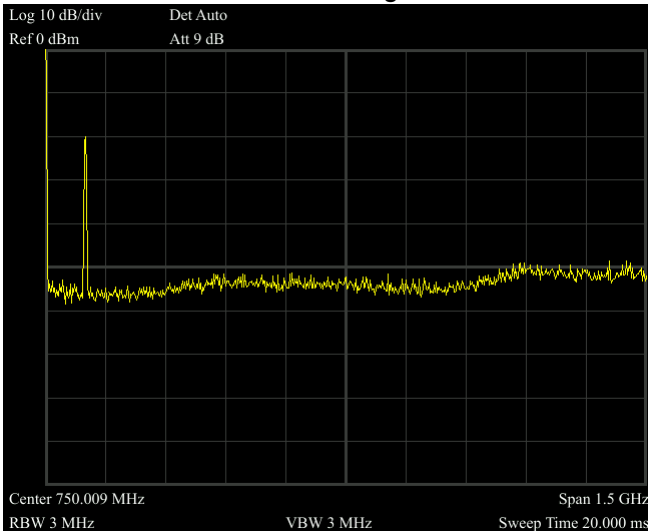

Figure 4-8 Full Span

## 4.Quick Start

To clearly observe the signal, reduce the span width to 1 Mhz and set the center frequency to 100MHz.

### 2) Setup the Center Frequency

Press “FREQ”, select [Center frequency] on corresponding pop up menu. Input “100” and select the unit as MHz on the numerical keyboard. The keys can be used to set the exact value but the knob and directional keys can also be used to set the center frequency.

### 3) Setup span

Press **【SPAN】**, input “1” and select unit MHz on the numerical keyboard. Or Press **【↓】** to decrease to 1MHz

Press **【BW】**, set [resolution bandwidth] to manual, and input “30” on the numerical keyboard and select the unit as kHz or press **【↓】** to decrease to 30kHz

Press **【Detector】**, set the detection type to positive peak.

Figure 4-9 shows the signal at a higher resolution.

Please not that resolution bandwidth, video bandwidth and span are self-adapted. They adjust to certain values according to sweep width. Also, sweep time can be self-adapted.

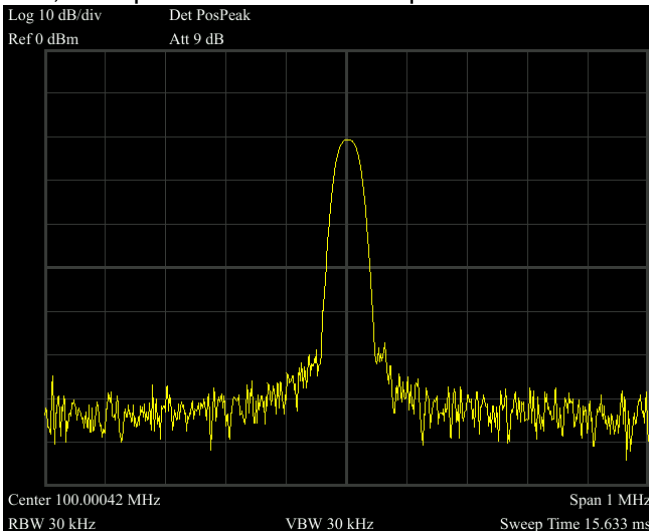

Figure 4-9 Set span

### 4) Activate Marker

—Press the Marker button in the function area. Press the soft key to select [Marker 1 2 3 4 5], select Marker 1, the marker is located at horizontal center by default, that is the signal peak point or its neighbor.



## 5. Troubleshooting

—Press Peak, and enter the next level menu, select [Max Search]. Frequency and amplitude values are read by the marker and shown on the top right of the display area.

### 5) Setup amplitude

The reference level will be shown at the top of the display grid. To get a better dynamic range, the real signal peak point should be located at or near the top of display grid (reference level). The reference level is also the maximum value on Y axis. Here we reduce to 20dB reference level to increase the dynamic range.

Press **【AMPTD】**, the amplitude setting menu will pop up, and the [reference level] soft key will be activated. The reference level can be input at the top left of the display grid. Input “-20” using the numerical keyboard and set the unit to dBm. You can also use the **【↓】** key or the knob for adjustment.

The reference level is set at -20dBm, which is the signal peak value near the top of the grid. The balance between the signal peak value and noise is dynamic range.

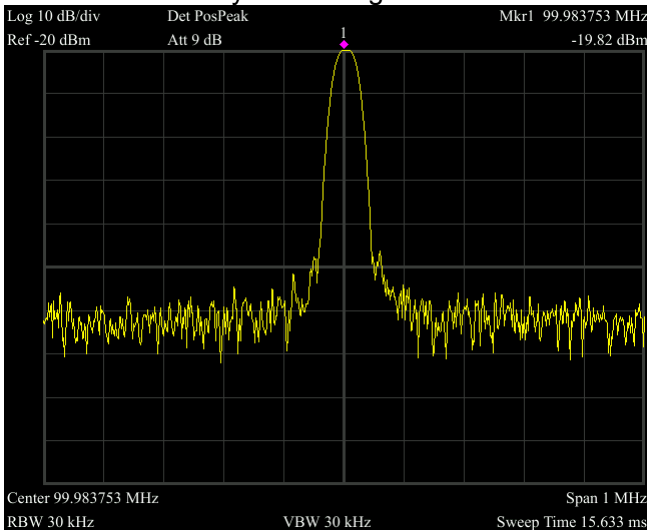

Figure 4-10 Set reference level

## 5. Troubleshooting

Typical issues that may occur when using your spectrum analyzer:

- Power on malfunction
- No signal display
- Wrong measurement results or poor frequency or amplitude

precision.

### **1. Power on malfunction**

Power on malfunction can include a situation where the screen is still dark (no display) after switch on.

If the screen is still dark after power on, please check:

- 1) If the power supply has been connected correctly and if the power supply voltage range is within the specification.
- 2) If the power switch has been turned on
- 3) If the fan is running, please contact OWON for service.

### **2. No signal display**

If there is no signal display at any wave band. Please try the following: set a signal generator at 30 MHz frequency and -20 dBm power and connect it to the spectrum analyzer RF input connector. If there is still no signal display, there may be a problem with the spectrum analyzer hardware circuit. Please contact OWON for service.

### **3. Wrong measurement results or poor signal frequency precision**

If the display contents shakes a lot or the frequency readout exceeds the error range during measurements, check if the signal source is stable. If so, check if spectrum analyzer reference is precise. Select internal or external frequency reference according to measurement conditions: press **【FREQ】**→[frequency reference Internal External]. If the frequency is still not precise, then the spectrum analyzer LO has lost its phase lock, please contact OWON for service.

### **4. Wrong measurement results or poor readout amplitude precision**

If signal amplitude readout is not precise, perform a calibration. If amplitude readout is still not precise, then it may be a problem with internal circuit, please contact OWON for service.

## 6. Appendix

### Appendix A: Enclosure

**Standard Accessories** (subject to final delivery):



Power Cord



CD Rom



Quick Guide



USB Cable

### Appendix B: General Care and Cleaning

#### General Care

Do not store or leave the instrument where the liquid crystal display could be exposed to direct sunlight for long periods of time.

**Caution:** To avoid any damage to the instrument or probes, do not expose it to any sprays, liquids, or solvents.

#### Cleaning

Inspect the instrument and probes as often as operating conditions require.

To clean the instrument exterior, perform the following steps:

Wipe the dust from the instrument surface with a soft cloth. Take care not to scratch the transparent LCD protection screen when cleaning.



---

#### **WARNING**

Before re applying power, ensure that the instrument is completely dry, avoiding any electric shock or electrical short circuit resulting from moisture.

---

### Appendix C: USB Disk Requirements

USB disk requirements:

Max capacity 4G, NTFS file system is not supported.

If the USB disk doesn't work properly, format your USB disk and then try again.