

Keysight M3202A

PXIe Arbitrary Waveform Generator
with Optional Real-Time Sequencing
and FPGA Programming

1 GSa/s, 14 Bits, 2/4 Channels

Data Sheet

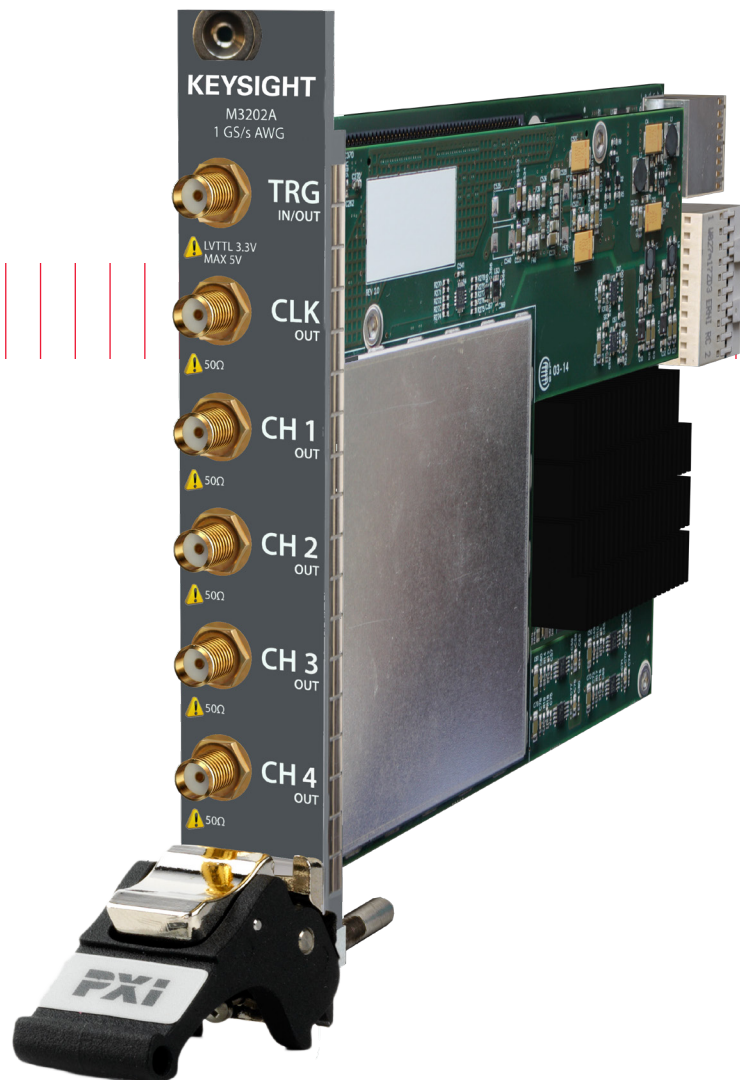

Generate High-Precision, Complex, Real-World Signals

The M3202A high-performance, high-bandwidth arbitrary waveform generator combines an advanced waveform generation system with embedded function generators and modulators (frequency/phase/amplitude) for broadband and IF signal generation. Performance meets simplicity thanks to easy-to-use programming libraries, real-time sequencing technology (Hard Virtual Instrumentation or HVI technology), and graphical FPGA programming technology.

Features

1 GS/s, 14 bits, 2/4 ch, 400 MHz BW (800 MHz IQ)

Embedded advanced arbitrary waveform generators (AWGs)

- Advanced triggering and marking (up to 8 reconfigurable I/Os)
- Waveform queue system with cycles, delays and prescalers

Embedded high-precision function generators (FGs)

- Sinusoidal, triangular, square, DC, and more
- 45-bit frequency resolution (up to $\sim 5.68 \mu\text{Hz}$)
- 24-bit phase resolution (up to $\sim 21.5 \mu\text{deg}$)

Embedded ultra-flexible amplitude and angle modulators

High-quality output signal with low phase noise

- SFDR: $\sim 54 \text{ dBc @}160 \text{ MHz}$
- Average noise density: down to $\sim -145 \text{ dBm/Hz}$

Optional features

- Simultaneous amplitude and angle modulations

Optional HW programming for high-performance applications

- Real-time sequencing (HVI technology)
- FPGA programming
 - Xilinx Kintex-7 325T or 410T FPGA

Up to 2 GB of onboard RAM ($\sim 1 \text{ Gsamples}$)

Mechanical/interface

- 1 slot 3U (PXIe)
- Up to 1.6 GB/s transfer BW with P2P capabilities (PCIe Gen 2)
- Independent direct memory access (DMA) channels for fast and efficient data transfer

Applications

Quantum computing, 5 G research

Manufacturing in wireless devices, automated test equipment (ATE)

MIMO, beam forming and other multi-channel coherent signal generation

General purpose, RF/arbitrary waveform generation

R&D/scientific research equipment, aerospace & defense (A/D)

Programming Technology and Software Tools

Software programming

- Easy-to-use native programming libraries for most common languages: C, C++, Visual Studio, LabVIEW, MATLAB, Python, and more

Hardware programming (optional)

- Real-time sequencing (Hard Virtual Instrumentation or HVI technology)
 - Graphical flowchart-style M3601A design environment (-HV1 option required on HW)
 - Ultra-fast, fully-parallelized, hard real-time execution
 - Ultra-fast, time-deterministic decision-making
 - Off-the-shelf inter-module synchronization & data exchange
- FPGA programming
 - Graphical M3602A FPGA design environment (-FP1 option required on HW)
 - No FPGA know-how required
 - Include from high-level to low-level design elements: off-the-shelf DSP blocks, MATLAB/Simulink designs, Xilinx CORE Generator IP cores, Xilinx VIVADO/ISE projects, VHDL or Verilog code
 - Ultra-fast, one-click compiling and on-the-fly programming

No programming

- Ready-to-use SD1 SPF (software front panels)

PXIe Arbitrary Waveform Generators, Digitizers and Combination Modules

Product	Type	Outputs (AWGs)				Inputs (Digitizers)			
		Speed (MSa/s)	Bits	Ch	BW (MHz)	Speed (MSa/s)	Bits	Ch	BW (MHz)
M3202A	AWG	1000	14	2/4	DC-400				
M3201A	AWG	500	16	2/4	DC-200				
M3102A	Digitizer					500	14	2/4	DC-200
M3100A	Digitizer					100	14	4/8	DC-100
M3302A	Combo	500	16	2	DC-200	500	14	2	DC-200
M3300A	Combo	500	16	2/4	DC-200	100	14	4/8	DC-100

Functional Block Diagram

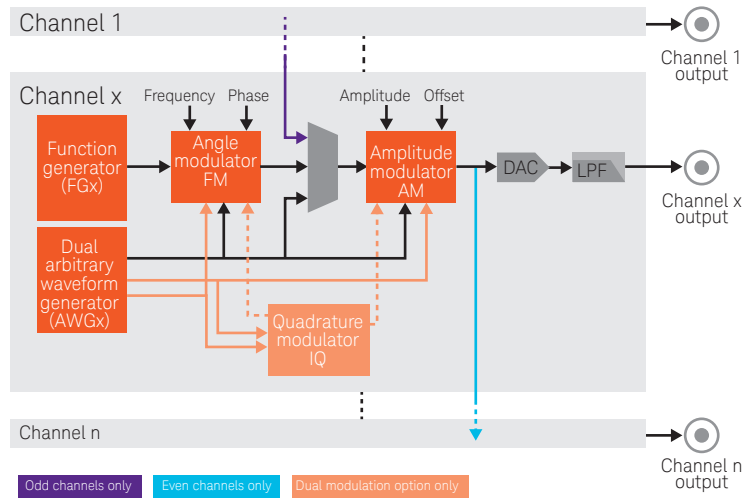

Figure 1. M3201A output functional block diagram, all channels have identical output structure

Ordering Information ¹

Product	Description
M3202A	PXI arbitrary waveform generator: 1 GSa/s, 14 Bits
Options	Description
M3202A-CH2 / -CH4	Two channels ² / four channels
M3202A-CLV / -CLF	Variable sampling clock ² / fixed sampling clock, low jitter
M3202A-DM1	Dual modulation capability (amplitude and angle simultaneously)
M3202A-M01 / -M12 / -M20	Memory 16 MB, 8 MSamples ² / 128 MB, 60 MSamples / 2 GB, 1 GSamples
HW programming options	Description
M3202A-HV1	Enabled HVI programming, requires an HVI design environment license (M3601A)
M3202A-FP1	Enabled FPGA programming, requires -K32 or -K41 option and an FPGA design environment license (M3602A)
M3202A-K32 / -K41	FPGA, Xilinx 7K325T / 7K410T, required for -FP1 option only (needs memory option -M20)
Related software	Description
M3601A	HVI design environment
M3602A	FPGA design environment

1. All options must be selected at time of purchase and are not upgradable
2. These options represent the standard configuration

Technical Specifications and Characteristics

General characteristics

Parameter	M3202A-CH2			M3202A-CH4			Units	Comments
	Min	Typ	Max	Min	Typ	Max		
Inputs and outputs								
Channels (single-ended mode)	2			4			Out	
Channels (differential mode)	1			2			Out	Differential uses 2 channels
Reference clock ¹	1			1			Out	
Reference clock ²	1			1			In	
Triggers/markers ^{1,3}	1			1			In/out	Reconfigurable
Triggers/markers ^{2,3}	8			8			In/out	Reconfigurable
Output channels overview								
Sampling rate ⁴	400		1000	400		1000	MSa/s	
Voltage resolution	14			14			Bits	
Output frequency	DC		400	DC		400	MHz	
Real-time BW	400			400			MHz	
Output voltage	-1.5		1.5	-1.5		1.5	Volts	
Built-in functionalities								
Function generators	2			4				1 per channel
Dual AWGs	2			4				1 per channel
IQ modulators	2			4				1 per channel
Frequency modulators	2			4				1 per channel
Phase modulators	2			4				1 per channel
Amplitude modulators	2			4				1 per channel
DC offset modulators	2			4				1 per channel
Onboard memory								
RAM memory	16		2048	16		2048	MBytes	

1. At front panel
2. At backplane
3. Markers available from firmware version v3.0 or later
4. (-CLV) option: 400 MSa/s to 1 GSa/s; (-CLF) option: fixed 1 GSa/s

I/O specifications

Parameter	M3202A-CH2			M3202A-CH4			Units	Comments
	Min	Typ	Max	Min	Typ	Max		
Output channels								
Sampling rate ¹	400		1000	400		1000	MSa/s	
Output frequency	DC		400	DC		400	MHz	Limited by a reconstruction filter
Output voltage	-1.5		1.5	-1.5		1.5	V _p	On a 50 Ω load
Source impedance		50			50		Ω	
Reference clock output								
Frequency		10 or 100			10 or 100		MHz	Generated from the internal clock, user selectable
Voltage		800			800		mV _{pp}	On a 50 Ω load
Power		2			2		dBm	On a 50 Ω load
Source impedance		50			50		Ω	AC coupled
External I/O trigger/marker								
V _{IH}	2		5	2		5	V	
V _{IL}	0		0.8	0		0.8	V	
V _{OH}	2.4		3.3	2.4		3.3	V	On a high Z load
V _{OL}	0		0.5	0		0.5	V	On a high Z load
Input impedance		10			10		K Ω	
Source impedance		TTL			TTL		-	
Speed		100			100		MHz	

1. (-CLV) option: 400 MSa/s to 1GSa/s; (-CLF) option: fixed 1 GSa/s

Function generators (FGs) specifications

Parameter	M3202A-CH2			M3202A-CH4			Units	Comments
	Min	Typ	Max	Min	Typ	Max		
General specifications								
Function generators	2			4			-	1 per channel
Waveform types	4			4			-	Sinusoidal, triangular, square and DC
Frequency range	0		400	0		400	MHz	
Frequency resolution	45			45			Bits	
Frequency resolution	11.4			11.4			μ Hz	
Phase range	0		360	0		360	Deg	
Phase resolution	24			24			Bits	
Phase resolution	21.5			21.5			μ deg	
Speed performance								
Frequency change rate	100			100			MChanges/s	With HVI technology
Frequency modulation rate	1000			1000			MSamples/s	With AWGs and angle modulators
Phase change rate	100			100			MChanges/s	With HVI technology
Phase modulation rate	1000			1000			MSamples/s	With AWGs and angle modulators

Amplitude and offset specifications

Parameter	M3202A-CH2			M3202A-CH4			Units	Comments
	Min	Typ	Max	Min	Typ	Max		
General specifications								
Amplitude / offset range	-1.5		1.5	-1.5		1.5	V_p	Amplitude + offset values
Amplitude / offset resolution	14			14			Bits	
Amplitude / offset resolution	122.1			122.1			μ V	
Speed performance								
Amplitude / offset change rate	1000			1000			MChanges/s	With HVI technology
Amplitude / offset modulation rate	1000			1000			MSamples/s	With AWGs and amplitude modulators

Arbitrary waveform generators (AWGs) specifications

Parameter	M3202A-CH2			M3202A-CH4			Units	Comments
	Min	Typ	Max	Min	Typ	Max		
General specifications								
Dual AWGs	2			4				1 dual AWG per output channel
Aggregated speed (16 bits)	4000			4000			MSa/s	For all onboard waveforms combined
Aggregated speed (32 bits)	2000			2000			MSa/s	For all onboard waveforms combined
Waveform multiple	10			10			Samples	Waveform length must be a multiple of this value
16-bit waveform length	30		957M	30		957M	Samples	Maximum depends on onboard RAM
32-bit waveform length	20		478M	20		478M	Samples	Maximum depends on onboard RAM
Waveform length efficiency	93.5			93.5			%	Effic. = waveform size / waveform size in RAM
Trigger	Selec.			Selec.				External trigger (input connector, backplane triggers), software trigger
AWG specifications (16-bit single waveform)								
Speed	1000			1000			MSa/s	Per AWG
Resolution	16			16			Bits	
AWG destination	Selec.			Selec.				Amplitude, offset, frequency or phase
AWG specifications (16-bit dual waveform)								
Speed (waveform A)	1000			1000			MSa/s	Per AWG
Speed (waveform B)	1000			1000			MSa/s	Per AWG
Resolution (waveform A)	16			16			Bits	
Resolution (waveform B)	16			16			Bits	
AWG destination (waveform A)	Selec.			Selec.				Amplitude, offset or I
AWG destination (waveform B)	Selec.			Selec.				Frequency, phase or Q
AWG specifications (32-bit single waveform)								
Speed	100			100			MSa/s	Per AWG, minimum prescaler: 1
Resolution	32			32			Bits	
AWG destination	Selec.			Selec.				Amplitude, offset, frequency or phase
AWG specifications (32-bit dual waveform)								
Speed (waveform A)	100			100			MSa/s	Per AWG, minimum prescaler: 1
Speed (waveform B)	100			100			MSa/s	Per AWG, minimum prescaler: 1
Resolution (waveform A)	32			32			Bits	
Resolution (waveform B)	32			32			Bits	
AWG destination (waveform A)	Selec.			Selec.				Amplitude or offset
AWG destination (waveform B)	Selec.			Selec.				Frequency or phase

Angle modulators specifications

Parameter	M3202A-CH2			M3202A-CH4			Units	Comments
	Min	Typ	Max	Min	Typ	Max		
General specifications								
Frequency modulators		2			4			1 per output channel
Phase modulators		2			4			1 per output channel
Carrier signal source		FGs			FGs			Table 3 on page 7
Modulating signal source		AWGs			AWGs			Table 5 on page 8
Frequency modulators (16-bit modulating waveform)								
Deviation	-Dev. gain		+Dev. gain	-Dev. gain		+Dev. gain	MHz	
Modulating signal resolution		16			16		Bits	AWG waveform
Modulating signal BW	0		500	0		500	MHz	AWG Nyquist limit
Deviation gain	0		400	0		400	MHz	
Deviation gain resolution		16			16		Bits	
Frequency modulators (32-bit modulating waveform)								
Deviation	-Dev. gain		+Dev. gain	-Dev. gain		+Dev. gain	MHz	
Modulating signal resolution		32			32		Bits	AWG waveform
Modulating signal BW	0		100	0		100	MHz	AWG Nyquist limit
Deviation gain	0		400	0		400	MHz	
Deviation gain resolution		16			16		Bits	
Phase modulators (16-bit modulating waveform)								
Deviation	-Dev. gain		+Dev. gain	-Dev. gain		+Dev. gain	Deg	
Modulating signal resolution		16			16		Bits	AWG waveform
Modulating signal BW	0		500	0		500	MHz	AWG Nyquist limit
Deviation gain	0		180	0		180	Deg	
Deviation gain resolution		16			16		Bits	~ 5.5 mdeg
Phase modulators (32-bit modulating waveform)								
Deviation	-Dev. gain		+Dev. gain	-Dev. gain		+Dev. gain	Deg	
Modulating signal resolution		16			16		Bits	AWG waveform is truncated
Modulating signal BW	0		100	0		100	MHz	AWG Nyquist limit
Deviation gain	0		180	0		180	Deg	
Deviation gain resolution		16			16		Bits	~ 5.5 mdeg

Amplitude modulators specifications

Parameter	M3202A-CH2			M3202A-CH4			Units	Comments
	Min	Typ	Max	Min	Typ	Max		
General specifications								
Amplitude modulators	2			4				1 per output channel
Offset modulators	2			4				1 per output channel
Carrier signal source	FGs			FGs				Table 3 on page 7
Modulating signal source	AWGs			AWGs				Table 5 on page 8
Amplitude & offset modulators (16-bit modulating waveform)								
Deviation	-Dev. gain	+Dev. gain		-Dev. gain	+Dev. gain		V_p	
Modulating signal resolution	16			16			Bits	AWG waveform
Modulating signal BW	0	500		0	500		MHz	AWG Nyquist limit
Deviation gain	0	1.5		0	1.5		V_p	
Deviation gain resolution	14			14			Bits	Limited by the output DAC
Amplitude & offset modulators (32-bit modulating waveform)								
Deviation	-Dev. gain	+Dev. gain		-Dev. gain	+Dev. gain		V_p	
Modulating signal resolution	16			16			Bits	AWG waveform is truncated
Modulating signal BW	0	100		0	100		MHz	AWG Nyquist limit
Deviation gain	0	1.5		0	1.5		V_p	
Deviation gain resolution	14			14			Bits	Limited by the output DAC

IQ modulators specifications

Parameter	M3202A-CH2			M3202A-CH4			Units	Comments
	Min	Typ	Max	Min	Typ	Max		
General specifications								
IQ modulators	2			4				1 per output channel
Carrier signal source	FGs			FGs				Table 3 on page 7
Modulating signal source	AWGs			AWGs				Table 5 on page 8
Amplitude deviation	-1.5		1.5	-1.5		1.5	V _p	
Phase deviation	-180		180	-180		180	Deg	
I modulating signal resolution	16			16			Bits	AWG waveform
I modulating signal BW	0		500	0		500	MHz	AWG Nyquist limit
Q modulating signal resolution	16			16			Bits	AWG waveform
Q modulating signal BW	0		500	0		500	MHz	AWG Nyquist limit

Clock system specifications

Parameter	M3202A-CH2			M3202A-CH4			Units	Comments
	Min	Typ	Max	Min	Typ	Max		
General specifications								
Clock frequency ¹	>400		1000	>400		1000	MHz	(-CLV) option: 400 MSa/s to 1GSa/s; (-CLF) option: fixed 1 GSa/s

1. (-CLV) option: 400 MSa/s to 1GSa/s; (-CLF) option: fixed 1 GSa/s

AC performance

Parameter	M3202A-CH2			M3202A-CH4			Units	Comments
	Min	Typ	Max	Min	Typ	Max		
General characteristics								
Analog output jitter		<2			<2		ps	RMS (cycle-to-cycle)
AWG trigger to output jitter		<2			<2		ps	RMS (cycle-to-cycle) for any trigger referenced to the chassis clock; independent of input trigger jitter if input jitter < 4nS peak-to-peak
Trigger resolution		10			10		ns	
Channel-to-channel skew		<20			<20		ps	Between ch 0 & ch 1, and ch 2 & ch 3
		<50			<50		ps	Between any channel
		<150			<150		ps	Between modules, chassis dependent ²
Clock output jitter		<2			<2		ps	RMS (cycle-to-cycle)
Clock accuracy and stability		100			100		ppm	PXIe, cPXIe versions; chassis dependent ¹
AC characteristics								
Spurious-free dynamic range (SFDR)								$P_{out} = 0$ dBm, measured from DC to max frequency
$f_{out} = 10$ MHz		68			68		dBc	
$f_{out} = 40$ MHz		66			66		dBc	
$f_{out} = 80$ MHz		62			62		dBc	
$f_{out} = 120$ MHz		58			58		dBc	
$f_{out} = 160$ MHz		54			54		dBc	
$f_{out} = 200$ MHz		53			53		dBc	
$f_{out} = 320$ MHz		55			55		dBc	
$f_{out} = 390$ MHz		58			58		dBc	
Crosstalk (adjacent channels)								
$f_{out} = 10$ MHz		<-105			<-105		dB	
$f_{out} = 40$ MHz		-85			-85		dB	
$f_{out} = 80$ MHz		-80			-80		dB	
$f_{out} = 120$ MHz		-89			-89		dB	
$f_{out} = 160$ MHz		-76			-76		dB	
$f_{out} = 200$ MHz		-86			-86		dB	
$f_{out} = 320$ MHz		-83			-83		dB	
Crosstalk (non-adjacent channels)								
$f_{out} = 10$ MHz		<-105			<-105		dB	
$f_{out} = 40$ MHz		-89			-89		dB	
$f_{out} = 80$ MHz		-81			-81		dB	
$f_{out} = 120$ MHz		-103			-103		dB	
$f_{out} = 160$ MHz		-95			-95		dB	
$f_{out} = 200$ MHz		-102			-102		dB	
$f_{out} = 320$ MHz		-97			-97		dB	

continued on next page

AC performance (continued)

Parameter	M3202A-CH2			M3202A-CH4			Units	Comments
	Min	Typ	Max	Min	Typ	Max		
AC characteristics								
Phase noise (SSB)								
offset = 1 kHz		<-127			<-127		dBc/Hz	
offset = 10 kHz		<-133			<-133		dBc/Hz	
offset = 100 kHz		<-138			<-138		dBc/Hz	
Average noise power density		<-145			<-145		dBm/Hz	

1. This value corresponds to a chassis that fulfils the PXI Express specifications. This value can be improved with an external chassis clock or a System Timing Module.
2. This value corresponds to a M9005A PXIe chassis.

AC performance, typical

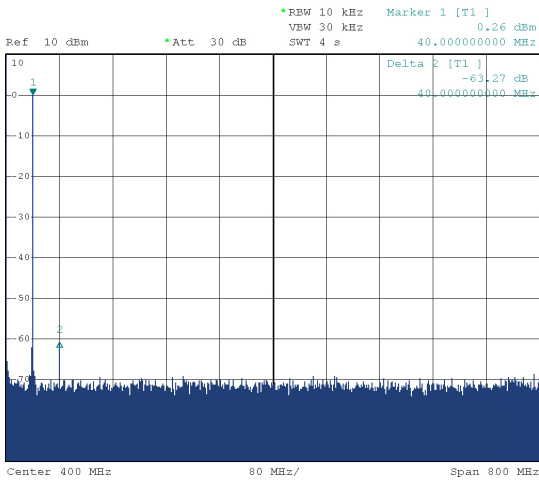

Figure 2. Single-tone spectrum @ $f_{out} = 40$ MHz

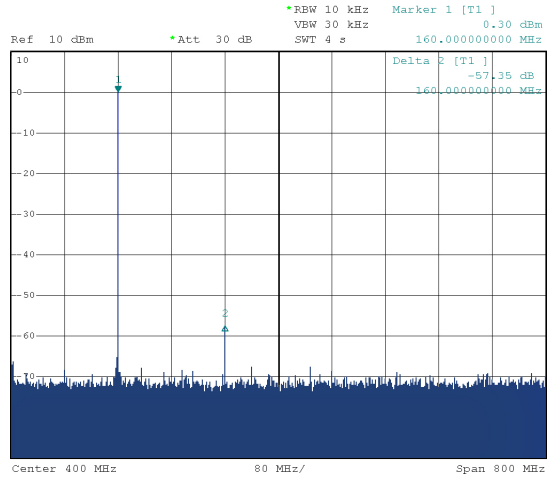

Figure 4. Single-tone spectrum @ $f_{out} = 160$ MHz

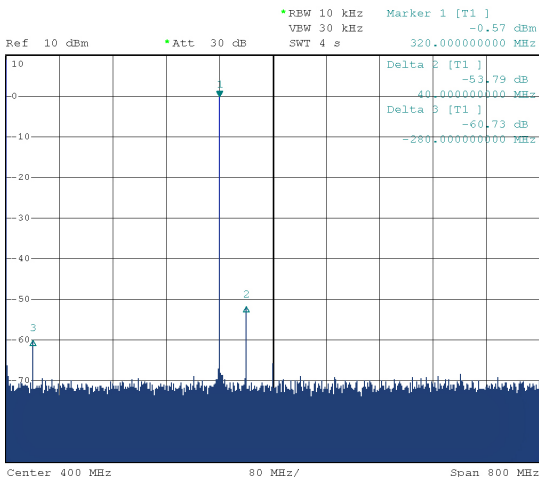

Figure 3. Single-tone spectrum @ $f_{out} = 320$ MHz

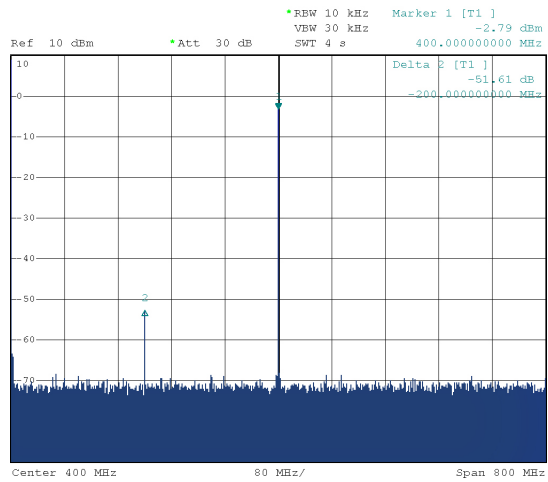

Figure 5. Single-tone spectrum @ $f_{out} = 400$ MHz

System Specifications

Environmental specifications (PXI Express)

Parameter	M3202A-CH2			M3202A-CH4			Units	Comments
	Min	Typ	Max	Min	Typ	Max		
System bus								
Slots	1			1			Slot	PXI Express (CompactPCI Express compatible)
PCI Express type	Gen 1		Gen 2	Gen 1		Gen 2	–	Automatic gen negotiation, chassis dependent
PCI Express link	1		4	1		4	Lanes	Automatic lane negotiation, chassis dependent
PCI Express speed	400		1600	400		1600	MBytes/s	Depends on # of lanes, chassis, congestion, and more
Sustainable throughput	200		800	200		800	MPoints/s	Depends on # of lanes, chassis, congestion, and more
Power and temperature								
3.3 V PXIe power supply	1.5			1.5			A	~ 5 W
12 V PXIe power supply	2			2			A	~ 24 W

Environmental ¹	
Temperature range	Operating Non-operating
	0 to +45°C (10,000 feet) -40 to +70 °C (up to 15,000 feet)
Max operative altitude	4000 m (10,000 feet)
Operating Humidity range (%RH)	10 to 95% at 40 °C
Non-operating Humidity range (%RH): 5 to 95	5 to 95%
Calibration interval	1 year
EMC	Complies with European EMC Directive – IEC/EN 61326-1 – CISPR Pub 11 Group 1, class A This ISM device is in compliance with Canadian ICES-001 Cet appareil ISM est conforme à la norme NMB-001 du Canada. This ISM device is in compliance with Australian and New Zealand RCM This ISM device is in compliance with South Korea EMC KCC

1. Samples of this product have been type tested in accordance with the Keysight Environmental Test Manual and verified to be robust against the environmental stresses of Storage, Transportation and End-use; those stresses include but are not limited to temperature, humidity, shock, vibration, altitude and power line conditions. Test Methods are aligned with IEC 60068-2 and levels are similar to MIL-PRF-28800F Class 3.

Evolving Since 1939

Our unique combination of hardware, software, services, and people can help you reach your next breakthrough. We are unlocking the future of technology. From Hewlett-Packard to Agilent to Keysight.

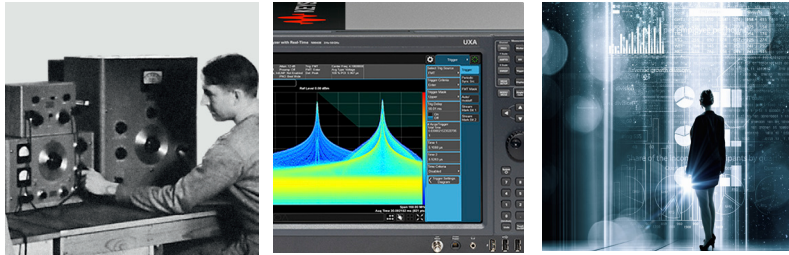

For more information on Keysight Technologies' products, applications or services, please contact your local Keysight office. The complete list is available at: www.keysight.com/find/contactus

Americas

Canada	(877) 894 4414
Brazil	55 11 3351 7010
Mexico	001 800 254 2440
United States	(800) 829 4444

Asia Pacific

Australia	1 800 629 485
China	800 810 0189
Hong Kong	800 938 693
India	1 800 11 2626
Japan	0120 (421) 345
Korea	080 769 0800
Malaysia	1 800 888 848
Singapore	1 800 375 8100
Taiwan	0800 047 866
Other AP Countries	(65) 6375 8100

Europe & Middle East

Austria	0800 001122
Belgium	0800 58580
Finland	0800 523252
France	0805 980333
Germany	0800 6270999
Ireland	1800 832700
Israel	1 809 343051
Italy	800 599100
Luxembourg	+32 800 58580
Netherlands	0800 0233200
Russia	8800 5009286
Spain	800 000154
Sweden	0200 882255
Switzerland	0800 805353
	Opt. 1 (DE)
	Opt. 2 (FR)
	Opt. 3 (IT)
United Kingdom	0800 0260637

For other unlisted countries: www.keysight.com/find/contactus (BP-9-7-17)

DEKRA Certified
ISO 9001 Quality Management System

www.keysight.com/go/quality
Keysight Technologies, Inc.
DEKRA Certified ISO 9001:2015
Quality Management System

This information is subject to change without notice.
© Keysight Technologies, 2017 - 2018
Published in USA, February 20, 2018
5992-1798EN
www.keysight.com

myKeysight

myKeysight

www.keysight.com/find/mykeysight

A personalized view into the information most relevant to you.

http://www.keysight.com/find/emt_product_registration

Register your products to get up-to-date product information and find warranty information.



www.pxisa.org

PCI eXtensions for Instrumentation (PXI) modular instrumentation delivers a rugged, PC-based high-performance measurement and automation system.

KEYSIGHT SERVICES
Accelerate Technology Adoption.
Lower costs.

Keysight Services

www.keysight.com/find/service

Keysight Services can help from acquisition to renewal across your instrument's lifecycle. Our comprehensive service offerings—one-stop calibration, repair, asset management, technology refresh, consulting, training and more—helps you improve product quality and lower costs.

Keysight Assurance Plans

www.keysight.com/find/AssurancePlans

Up to ten years of protection and no budgetary surprises to ensure your instruments are operating to specification, so you can rely on accurate measurements.

Keysight Channel Partners

www.keysight.com/find/channelpartners

Get the best of both worlds: Keysight's measurement expertise and product breadth, combined with channel partner convenience.

www.keysight.com/find/m3202a

