

# CX3300 Series Device Current Waveform Analyzer

Extend your advantage in lower power design by analyzing in-depth current and voltage waveforms



CX3322A 2 Channel  
CX3324A 4 Channel  
CX1101A  
CX1102A  
CX1103A

CX1104A  
CX1105A  
CX1151A  
CX1152A

## Table of Contents

|  |    |
|--|----|
| Product Overview .....   | 03 |
| Strong Needs in Precision Dynamic Current Measurement.....   | 05 |
| Challenges in Co nventional Dynamic Current Measurements.....  | 07 |
| CX3300 Series Addresses Customer’s Challenges .....  | 09 |
| Up to 200 MHz Bandwidth and $1 \times 10^{12}$ Wide Measurement Range Enable<br>You to Use the CX3300 Series for Your Applications.....      | 11 |
| The 14 and 16-Bit Wide Dynamic Range Allows You to Measure Current<br>Waveforms from Sleep to Active States with Just a Single Capture ..... | 12 |
| Never Miss Any Transient Current in Your Device Characterization and<br>Validation by the 1 GSa/s Sampling Rate and 200 MHz Bandwidth .....  | 14 |
| CX3300 Series Standard Features and Key Accessories.....   | 15 |
| Comparison Table for Available Sensors.....  | 19 |
| The Intuitive User Interface and Sophisticated Measurement/Analysis<br>Capabilities Improve Measurement and Analysis Efficiency .....        | 21 |
| Key Characteristics.....   | 26 |
| Ordering Information .....   | 29 |
| CX3300 Series Characteristics.....   | 31 |
| CX1100 Series Current/Differential Sensors Characteristics.....  | 36 |
| CX1101A Characteristics .....  | 36 |
| CX1102A Characteristics .....  | 38 |
| CX1103A Characteristics .....  | 40 |
| CX1104A Characteristics .....  | 41 |
| CX1105A Characteristics .....  | 43 |
| CX1211A/CX1212A/CX1213A/CX1214A/CX1215A/CX1216A Characteristics .....  | 46 |
| CX1151A Passive Probe Interface Adapter Characteristics.....   | 47 |
| CX1152A Digital Channel Characteristics (Mainframe: CX3324A Only).....   | 48 |
| CX3300 Series Dimensional Drawing (Mainframe).....   | 49 |

## Product Overview

The CX3300 series Device Current Waveform Analyzers is a new category of instruments enabling precision dynamic current measurements with wide measurement range (from 100 pA-level to 100 A), wide bandwidth (up to 200 MHz) and high resolution (up to 16-bit).

Most engineers working on the development of IoT and mobile devices usually face high pressure due to tight time-to-market demand of their products, while not compromising on product goals such as lower power consumption, higher performance and lower cost. To overcome this tough situation, they are always struggling to make device characterization and design validation more efficient and effective. However, achieving these goals is becoming more difficult with conventional measurement methods based on existing instruments because of the surge in complexities of device functions.

When measuring and analyzing detailed current profile of power delivery network (PDN) with the CX3300 series, you can directly and precisely verify the critical device operations previously not visible due to large noise. This allows you to make various design improvements required for more power reduction. With insights obtained by this new method of dynamic current measurements, you can not only improve the efficiency of device characterization and validation, but also contribute to product differentiations, design margin optimizations, components cost down and device quality improvements. The CX3300 series consists of mainframes featuring 14/16-bit resolution, easy-to-use advanced GUI, and five low noise and wide bandwidth sensors. Since you can also measure the same precision voltage waveforms easily, it can be widely applied to your everyday measurement workflow.

The CX3300 series has been used by a wide variety of application areas since it was released, especially by research and development customers for IoT device, mobile device, advance NVM (Non-Volatile Memory) device, sensor and control unit for automotive, medical/healthcare device, etc.



## What is the CX3300 series for?

You can precisely measure dynamic current that was previously difficult or impossible to measure.

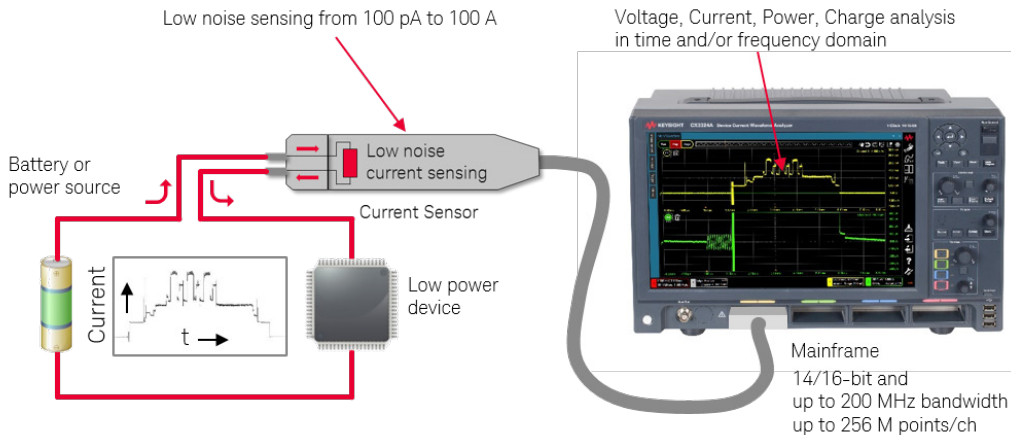


Figure 1. Illustrative view of device current waveform analysis by the CX3300 series.

## Which technologies can benefit from this application?

The CX3300 series is applicable in a wide range of technologies shown below, and the application coverage is growing wider. All devices which require a wide dynamic range in current measurement can benefit from this application.



Figure 2. CX3300 series' application examples.

# Strong Needs in Precision Dynamic Current Measurement

## Characterization and validation of PDN (Power Delivery Network) in IoT and mobile devices

Explosive growth of IoTs urges designs to be more integrated for higher performance with less power by employing sophisticated power-gating techniques and active and sleep operations, as well as realizing low power supply voltage and current to meet the thermal budget. As a result, characterization and design validation of such devices are becoming quite challenging.

To ensure reliable operation, evaluation of PDN is at the heart of characterization and validation, required not only for packaged ICs, but also for system boards where a lot of components are mounted.

Figure 3 shows a typical block diagram of battery powered devices used in IoT and mobile applications. The validation engineers usually measure dynamic current of the PDN going through every power line to carefully evaluate inrush current, wake-up behavior, power consumptions, unexpected spikes, etc. as in the current profile shown in Figure 4, sometimes leading to modify the components selections in the PDN and the control sequence of the device firmware.

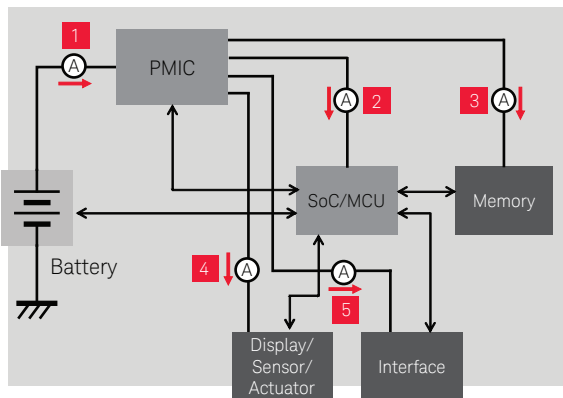


Figure 3. Typical block diagram.

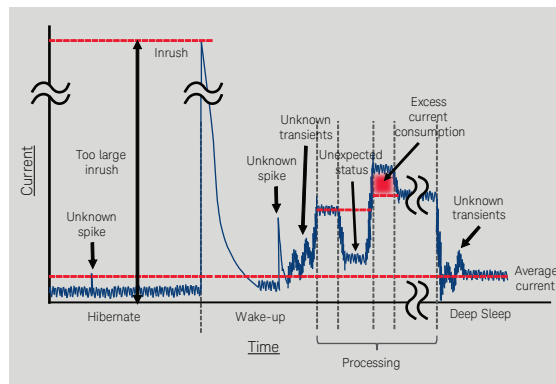


Figure 4. Conceptual current profile for PDN.

## Power consumption reduction for low-power IoT devices

The operation of low-power IoT and mobile devices consists of short active state and long sleep/standby state to save the total power consumption, as shown in Figure 5. Average current measurement is an essential characteristic for all these low-power devices but this is not sufficient if you are looking to further power consumption reduction. Since the sleep/standby state is going longer for more power reduction, more detailed and quantitative dynamic current measurements are required not only for the active state, but also for the sleep/standby period, where current consumption is usually as small as 1  $\mu$ A or less.

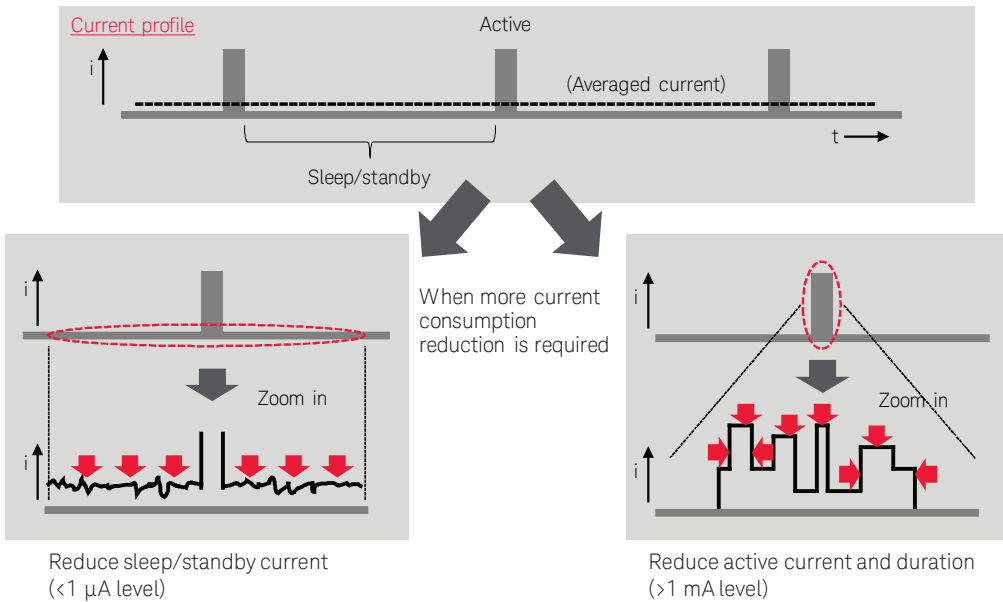


Figure 5. Typical operation of low-power IoT devices and the further power reduction.

## Characterization for novel NVM devices

Due to a strong demand for higher speed, lower latency and more reliability in novel NVM devices such as RRAM, PCM and MRAM, a wide variety of advance NVM devices are being developed all over the world. Characterizing these devices requires transient current measurements between read, write and erase periods to evaluate how the resistance changes in the device. Since the power consumption for these devices needs to be minimized, the measured current must also be minimized down to  $100 \mu\text{A}$  or less, while the pulse width for write and erase operations is as short as  $100 \text{ ns}$  or less (Figure 6).

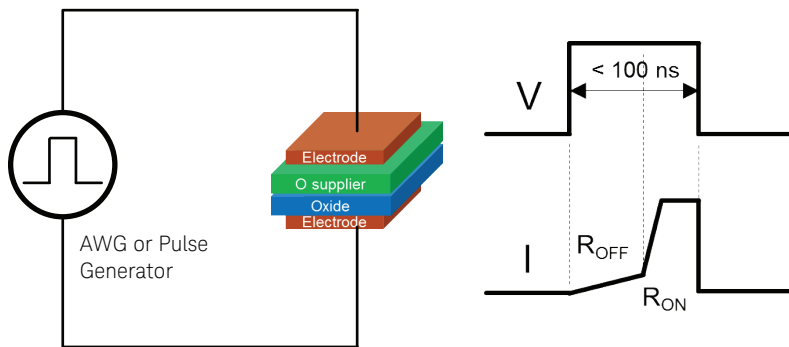


Figure 6. Pulse measurement for novel NVM devices.

# Challenges in Conventional Dynamic Current Measurements

## Existing tools/instruments are not sufficient

As shown in Table 1, there are popular tools/instruments to measure dynamic current available in market, but each of them alone is not sufficient to perform quantitative measurement and analysis of dynamic current due to the measurement limitations such as large noise in oscilloscopes and probes, cumbersome degaussing and adjustments, limited bandwidth, maximum input current vs. frequency derating, etc.

For example, an oscilloscope with differential probe or clamp-on current probe is handy and has wide measurement bandwidth, but its usage is limited in low-level dynamic current measurements due to its relatively large noise floor.

A DMM is useful when you measure average current, but is not appropriate when you measure higher frequency current due to its low sampling rate and narrow bandwidth. You may be able to achieve a certain level of measurement objectives with your in-house solutions; however, the solutions offer only limited insights.

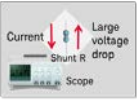


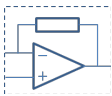
| Measurement tool  | Pros   | Cons  | Minimum measurable current  |
|---|--|---|---|
|    | Shunt resistor + differential probe + oscilloscope | <ul style="list-style-type: none"> <li>– Wide bandwidth</li> <li>– Ease of measurement</li> <li>– Low cost</li> </ul> | <ul style="list-style-type: none"> <li>– Noise floor</li> <li>– V drop vs. sensitivity</li> <li>– Dynamic range</li> </ul> > 1 mA |
|    | Clamp-on type current probe + oscilloscope         | <ul style="list-style-type: none"> <li>– Ease of measurement</li> <li>– Non-intrusive</li> </ul>                      | <ul style="list-style-type: none"> <li>– Noise floor</li> <li>– Adjustment</li> <li>– Frequency derating</li> </ul> > 1 mA        |
|  | DMM (Digital Multimeter)                           | <ul style="list-style-type: none"> <li>– Low current</li> <li>– High accuracy</li> <li>– Low cost</li> </ul>          | <ul style="list-style-type: none"> <li>– Bandwidth</li> <li>– Graphical User Interface</li> </ul> < 1 $\mu$ A                     |
|  | In-house solution                                  | <ul style="list-style-type: none"> <li>– Low cost</li> <li>– Optimized</li> </ul>                                     | <ul style="list-style-type: none"> <li>– Supportability</li> <li>– Flexibility</li> </ul> < 1 $\mu$ A                             |

Table 1. Existing tools/instruments for dynamic current measurement.

## It takes a great deal of effort to finalize measurements and analyses

As shown in Figure 5, since most IoT and mobile devices operate intermittently between a short active state and a long sleep/standby state to reduce power consumption. A wide dynamic range measurement capability is required to cover all these states to make appropriate analyses. However, due to the measurement challenges listed in Table 1, it is very difficult to measure the acceptable current profile with a single instrument. As a result, you usually apply a combination of different instruments and multiple shunt resistors to cover the required ranges. However, this method is time consuming, due to the many measurement iterations required to improve measurement fidelity. You may also struggle with data discrepancies due to different measurement conditions that are inherent in different tools/instruments (Figure 7). Such issues keep you from improving the efficiency in characterization and design validation. Consequently, the product cost is affected by the need to have additional margins against error.

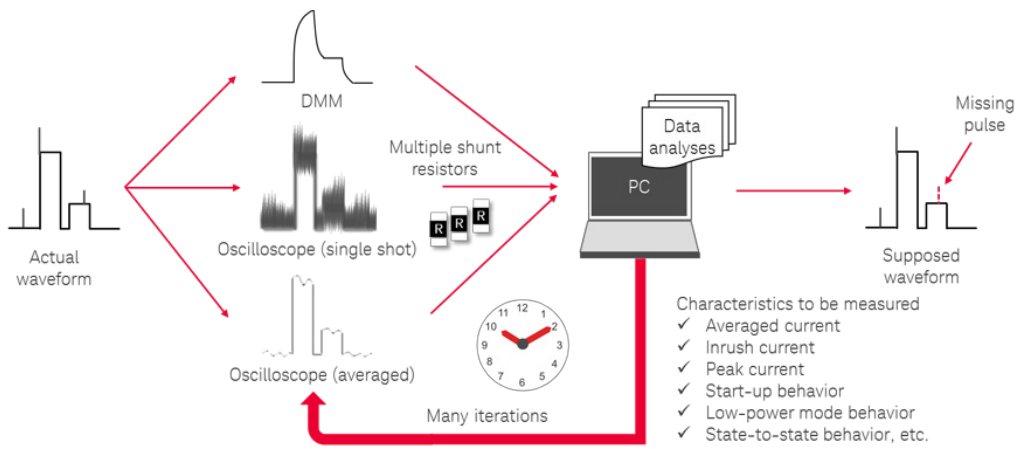


Figure 7. Characterization and design validation with existing tools/instruments is time-consuming.

### Wide bandwidth and low noise performance is required

In the case of characterization for advanced NVM devices such as RRAM or PCM, wide bandwidth and low-level dynamic current measurements are required. However, existing instruments do not allow you to measure detailed low level transient current due to the high noise level from the oscilloscope and the probe. As a result, a compromise has to be made between measurement resolution and accuracy (Figure 8).

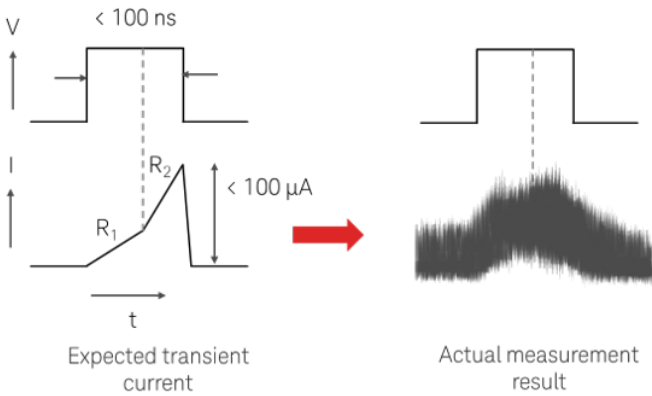


Figure 8. Low-level transient current cannot be seen easily.



## CX3300 Series Addresses Customer's Challenges

The CX3300 series is a breakthrough standalone instrument with the capability to resolve these measurement issues. It enables a wide dynamic range measurements with the versatile sensors and adapters. The combination of wide bandwidth, low noise, 14/16-bit high resolution and easy-to-use GUI capabilities provide better test efficiency and evaluation compared to oscilloscopes.

### How does the CX3300 series change current waveform measurements?

CX3300 series provides cleaner waveforms than any other conventional dynamic current measurement tool/instrument in the market. Figure 9 shows the conceptual current profile comparison taken by a conventional instrument and by the CX3300 series. Due to measurement limitations, you always end up with high noise, low bandwidth measurements. As a result, it takes a lot of time and effort to complete required analyses for your devices. In addition, it is especially difficult to measure what is going on in the low-level current states.

With a CX3300 series instrument, you can easily measure low noise dynamic current with wide bandwidth, and will never miss any critical behavior in your devices throughout the required dynamic range.

It is essential to make quantitative analyses using clean waveforms during the device characterization and design validation process, and the CX3300 series is the only instrument that makes this possible.

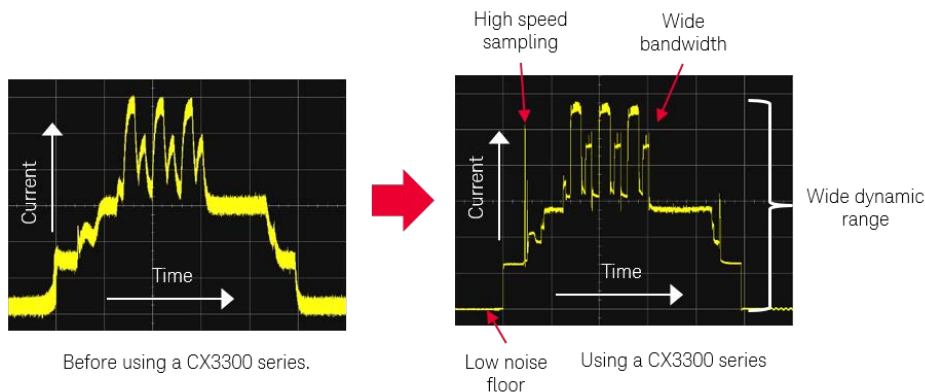


Figure 9. Waveform comparison.

## How does the CX3300 series measure dynamic current?

The CX3300 series consists of two mainframes, five unique and versatile sensors having different measurement ranges, and two adapters enabling voltage measurements. Figure 10 shows an overview of CX3300 series products. The sensors can be categorized into two types with respect to the current measurement method: one to directly measure dynamic current in the sensor, the other one to measure differential voltage across a shunt resistor in the customer's measurement board. The passive probe adapter enables you to use a passive probe to measure voltage like a 14/16-bit high resolution oscilloscope. Since the GUI also includes many advanced features and useful analysis tools, you can make simple but precise measurements and analyses swiftly.

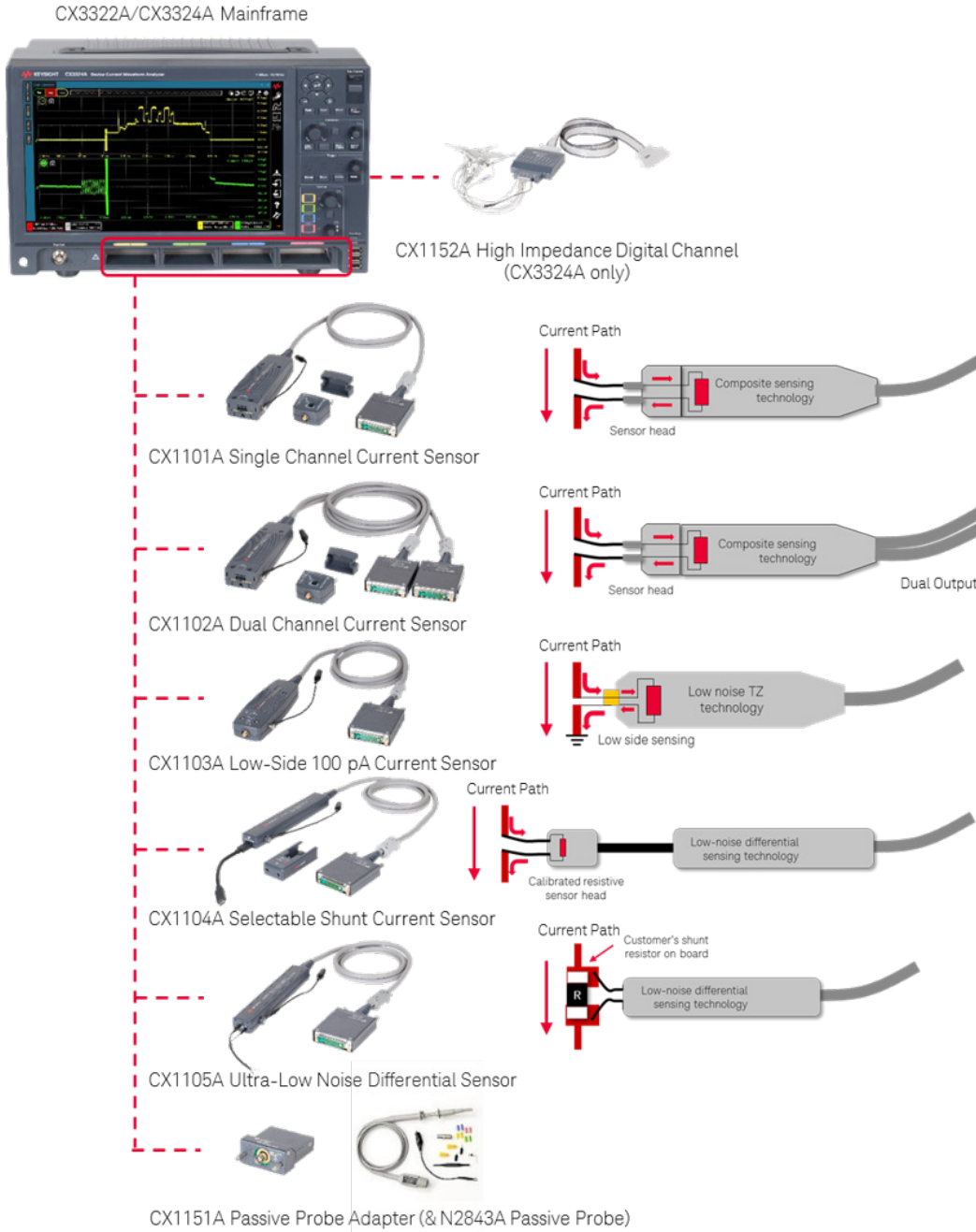


Figure 10. CX3300 series products and how to measure current.

# Up to 200 MHz Bandwidth and $1 \times 10^{12}$ Wide Measurement Range Enable You to Use the CX3300 Series for Your Applications

Figure 11 illustrates the CX3300 series' measurement area with respect to the measurement bandwidth and the current measurement ranges. The wide coverage allows you to make any dynamic current measurement and analysis all your application needs.

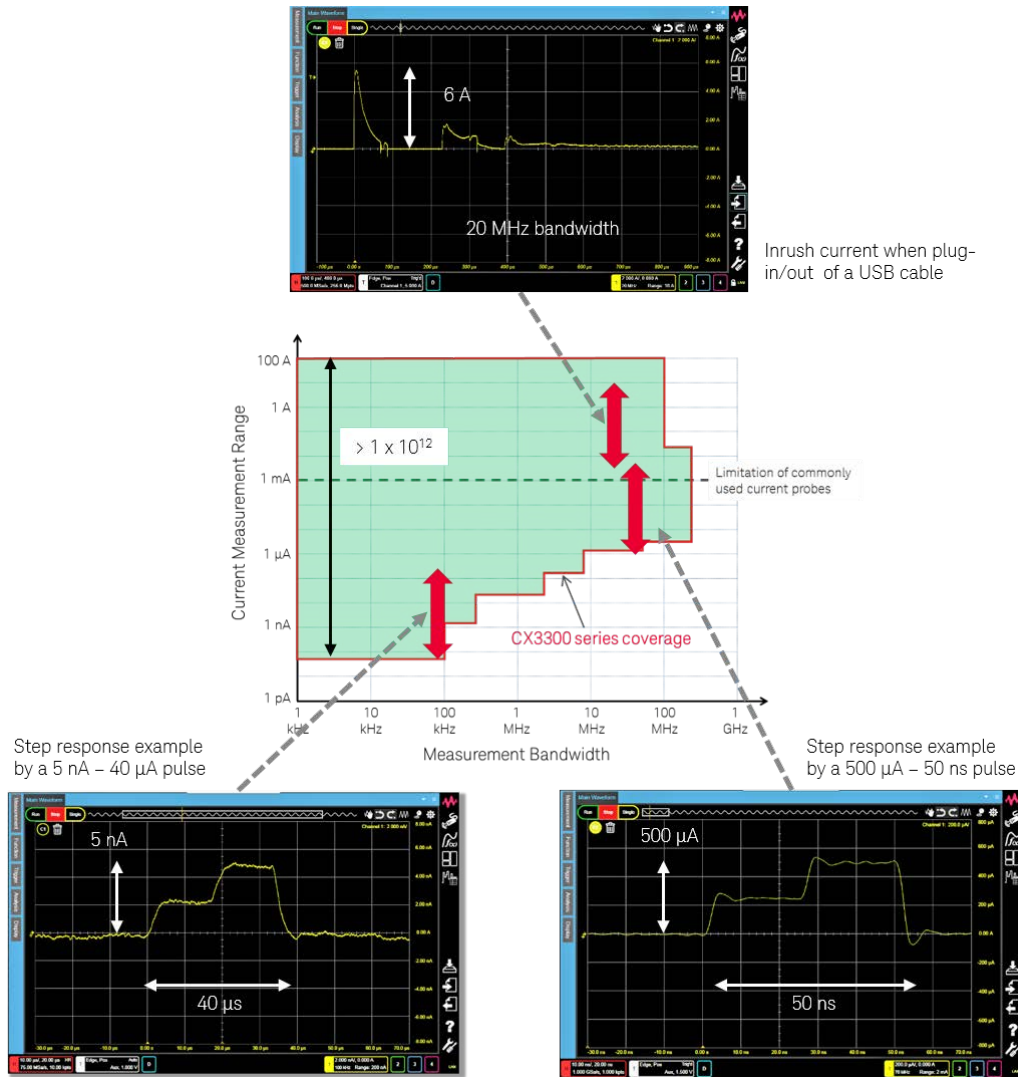


Figure 11. CX3300 series' measurement area.

# The 14 and 16-Bit Wide Dynamic Range Allows You to Measure Current Waveforms from Sleep to Active States with Just a Single Capture

A wide dynamic range is required to perform current measurements, especially for low power device applications consisting of sleep/standby and active states. The CX3300's mainframes and dedicated sensors enable up to 5-decade dynamic range measurements in a single capture.

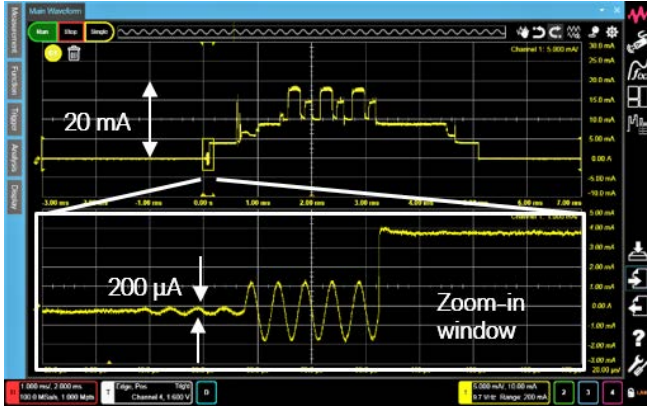


Figure 12. "Anywhere" Zoom function.

An easy-to-use "Anywhere" Zoom function allows you to, at any time, zoom in anywhere on the waveform

Following a few simple steps on the front panel or by clicking an icon in the waveform window to instantly enables the "Anywhere" zoom function. "Anywhere" Zoom allows you to zoom in on any areas of interest including both vertical and horizontal scaling. As a result, you can fully utilize the CX3300's 14 and 16-bit high resolution.



Figure 13. Dual Channel current sensing.

The Dual Channel Current Sensor achieves 100 dB dynamic range to visualize low-power device operations

The CX1102A Dual Channel Current Sensor enables simultaneous measurements with two different measurement ranges. For example, the primary channel is set to a 20 mA range, while the secondary channel is automatically set to a 200 µA range enabling sub-µA measurement (the primary channel's range is 50 or 100 times larger than that of secondary channel). This configuration is very useful for low-power applications having an intermittent operation between sleep/standby and active states.

## The differential sensor enables a non-intrusive current measurement by making use of the industry-lowest-noise differential voltage measurements

The CX1105A Ultra-Low Noise Differential Sensor measures a differential voltage across your shunt resistor on evaluation/test board and converts the measurement result into current on the CX3300's mainframe. It offers a low-level input noise smaller than any existing differential probes for oscilloscopes. Figure 14 shows a measurement example of differential voltage using a CX1105A and a 50 mΩ shunt resistor. The whole waveform is captured at 1 mV scale (equivalent to 20 mA) with high waveform fidelity. Due to the low noise performance of this sensor, you can measure a wide range of dynamic current depending on the shunt resistor value used.

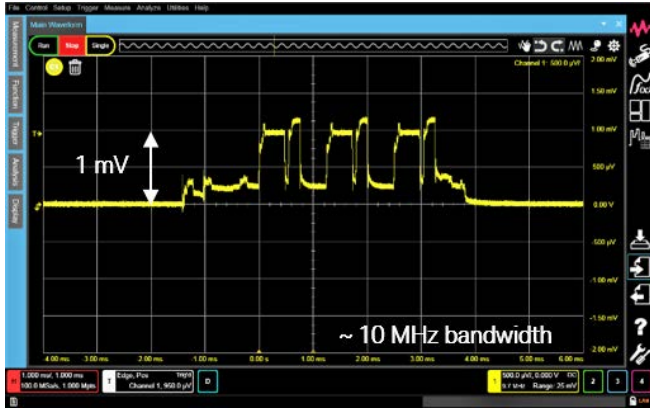


Figure 14. An example of CX1105A's differential voltage measurement.

## All channels can be switched to 16-bit resolution quickly

The “High Reso” key allows you to change the resolution from a 14-bit (high speed mode) to a 16-bit (high resolution mode) anytime to observe detailed waveforms. The 16-bit mode is especially effective for measurement bandwidth lower than 1 MHz.

1. The maximum bandwidth of 16-bit mode is limited to 14 MHz. Please see the datasheet part of this document for more detail.



Figure 15. High resolution key for 16-bit resolution.

# Never Miss Any Transient Current in Your Device Characterization and Validation by the 1 GSa/s Sampling Rate and 200 MHz Bandwidth

Most engineers may not be aware of a very sharp current pulse due to a lower measurement bandwidth and/or slow acquisition rate. The CX3300's fast and wideband measurement capabilities capture never seen before fast transient current waveforms and show them clearly on display. As a result, you can not only improve the debug efficiency, but can select the right components by knowing the peak current.

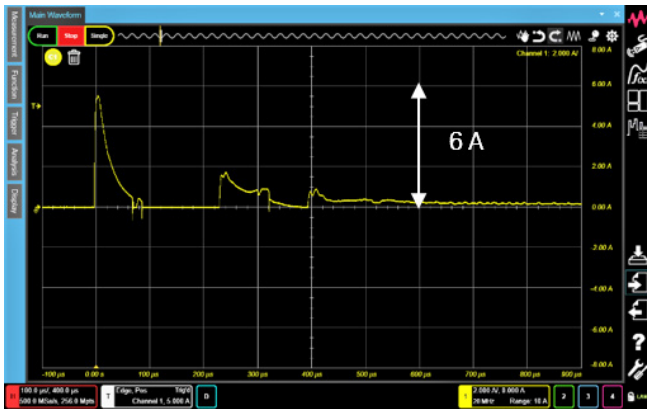


Figure 16. Inrush current measurement by CX1104A.

## Capture inrush and peak current without measurement restrictions

Selecting the right passive components ensures that the DUT does not brown out during high current events. Using the CX1104A Selectable Shunt Current Sensor and a calibrated resistive sensor head, you can measure clean and accurate waveform up to 15 A without having to be concerned about frequency derating or pulse width restrictions usually seen in the case of current probe measurements.



Figure 17. High speed current pulse measurement.

## The wide bandwidth enables narrow current pulse measurement

Easily measure fast, low-level transient current with less than 100 ns pulse width to evaluate and analyze two terminal devices such as RRAM, PCM, MRAM, etc.

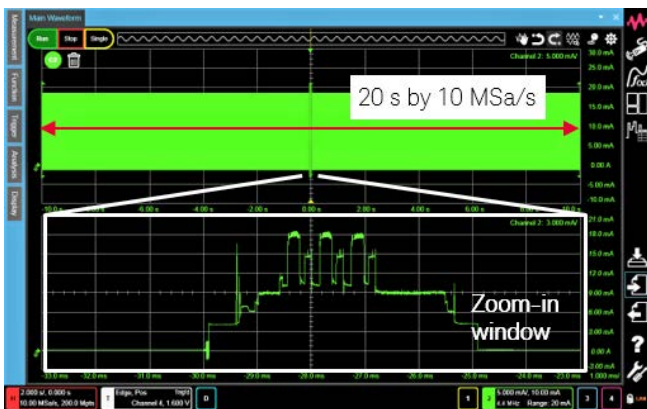


Figure 18. "Anywhere" Zoom function.

## The high acquisition rate and deep memory store a long time transient without compromising the fidelity

Up to 256 Mpts/ch memory depth and the fast acquisition rate allows you to capture long-duration waveforms to find unexpected current peaks. Using the "Anywhere" zooming function (described in a previous section) allows you to clearly identify any areas of interest on the measured waveform.

# CX3300 Series Standard Features and Key Accessories

The mainframe enables unprecedented measurement capabilities and intuitive and easy-to-use graphical user interface

The CX3300 series do not compromise in terms of wide bandwidth low noise sensing, and clearly visualizes low-level current waveforms on the 14.1 inch wide screen. The advanced but familiar graphical user interface with a user friendly touch screen allows you to easily start measurements and obtain accurate data for critical analysis from the first use. It also provides common interface connectivity to meet various customer needs.

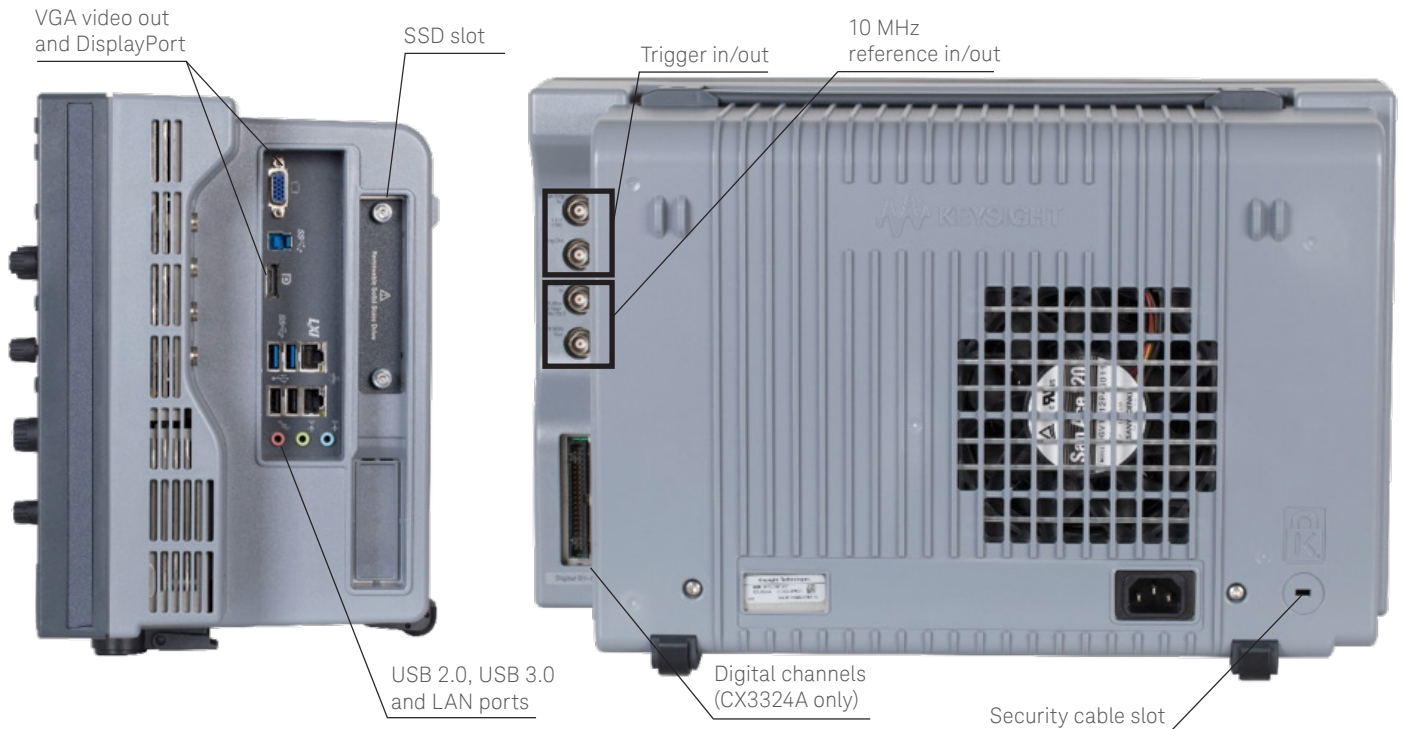


Figure 19. CX3324A front, side and rear views.

## Dedicated versatile sensors and accessories to meet a wide range of dynamic current measurement needs



Figure 20. CX1101A single channel current sensor.

**CX1101A** is a basic current sensor widely used for many low power device applications. High frequency noise is suppressed by the composite current sensing technology.

- 40 nA to 1 A (10 A with CX1206A)
- > 80 dB dynamic range
- 100 MHz maximum bandwidth
- $\pm 40$  V common mode voltage
- Use a sensor head to connect to your DUT



Figure 21. CX1102A dual channel current sensor.

**CX1102A** enables simultaneous dual range measurement based on the composite current sensing technology similar to the CX1101A. It is useful for measuring sleep/standby and active current at a single acquisition.

- 40 nA to 1 A
- > 100 dB dynamic range
- 100 MHz maximum bandwidth
- $\pm 12$  V common mode voltage
- Use two channels on the mainframe
- Use a sensor head to connect your DUT.

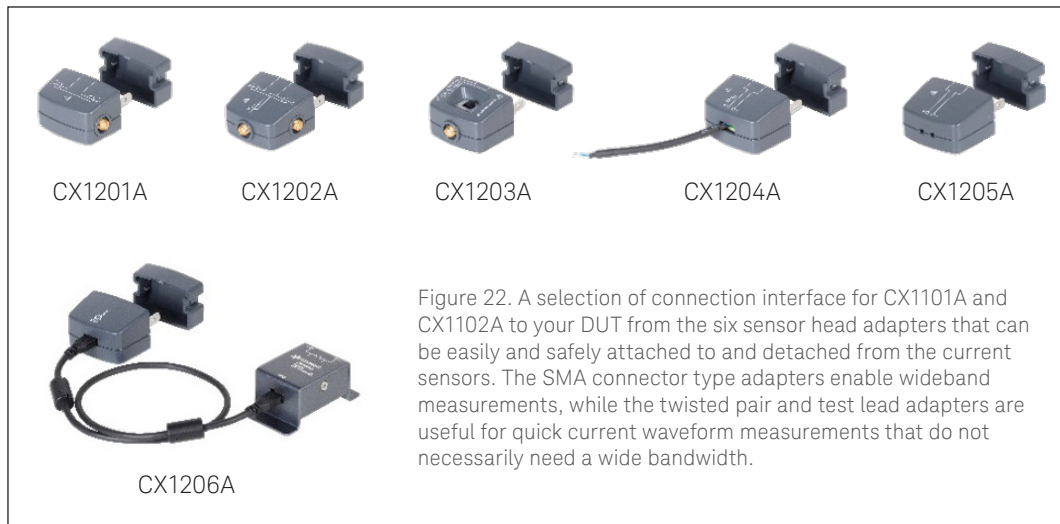


Figure 22. A selection of connection interface for CX1101A and CX1102A to your DUT from the six sensor head adapters that can be easily and safely attached to and detached from the current sensors. The SMA connector type adapters enable wideband measurements, while the twisted pair and test lead adapters are useful for quick current waveform measurements that do not necessarily need a wide bandwidth.





Figure 23. CX1103A low-side 100 pA current sensor.

CX1103A provides the widest measurement bandwidth in the CX3300 series sensors. It is based on low-noise transimpedance amplifier technology.

- 150 pA to 20 mA
- > 80 dB dynamic range
- 200 MHz maximum bandwidth
- Low side only (measures current to ground)
- Precision current source for offset cancellation

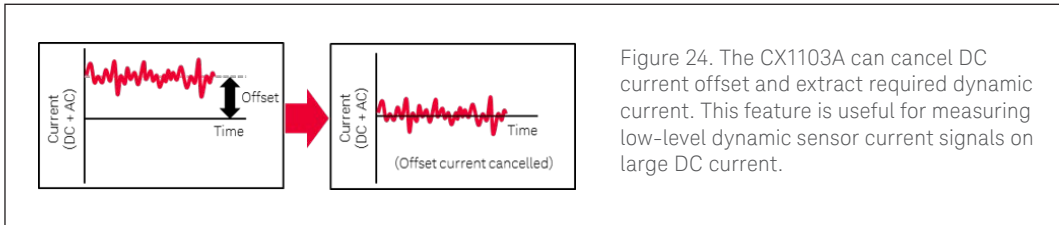


Figure 24. The CX1103A can cancel DC current offset and extract required dynamic current. This feature is useful for measuring low-level dynamic sensor current signals on large DC current.



Figure 25. CX1104A selectable shunt current sensor.

CX1104A enables accurate dynamic current measurements up to 15 A with wide dynamic range down to 1  $\mu$ A level. It requires a resistive sensor head calibrated at Keysight before shipment. It also provides stable and flat frequency response up to 20 MHz.

- 1  $\mu$ A to 15 A
- > 80 dB dynamic range
- 20 MHz maximum bandwidth
- $\pm$  40 V common mode voltage

Figure 26. CX1211A to CX1216A resistive sensor head.

| Product | Maximum current | Insertion resistance |
|---------|-----------------|----------------------|
| CX1211A | 15 A            | 5.5 m $\Omega$       |
| CX1212A | 10 A            | 8.0 m $\Omega$       |
| CX1213A | 5 A             | 23 m $\Omega$        |
| CX1214A | 3 A             | 53 m $\Omega$        |
| CX1215A | 2 A             | 103 m $\Omega$       |
| CX1216A | 250 mA          | 1.0 $\Omega$         |

Table 2. You can select from a range of resistive sensor head for your application. As each sensor head is calibrated, you can always make accurate dynamic current measurements.



Figure 27. CX1105A ultra-low noise differential sensor.

CX1105A is a wide bandwidth and industry-lowest-noise differential sensor for voltage measurement across shunt resistors on evaluation/test board. You can measure current waveforms by inputting the resistor value with the mainframe.

- Non-intrusive current measurement
- 1  $\mu$ A to 100 A (depending on your shunt resistor)
- > 80 dB dynamic range
- 100 MHz maximum bandwidth
- $\pm$  40 V/6 V common mode voltage

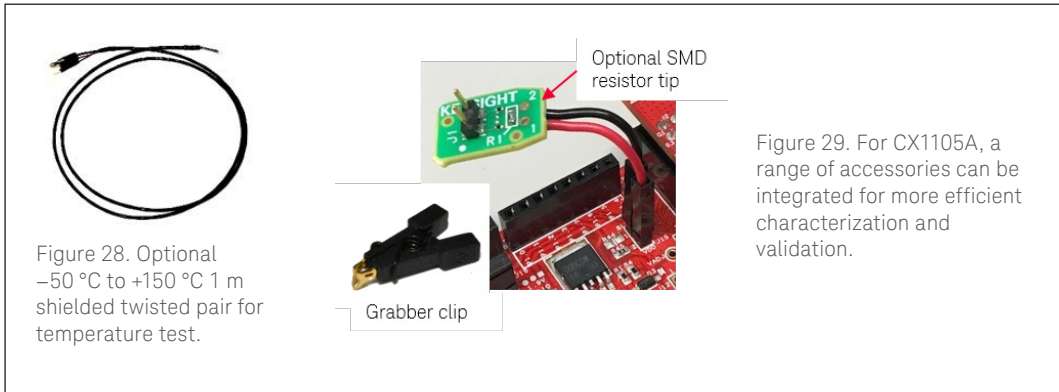


Figure 28. Optional -50 °C to +150 °C 1 m shielded twisted pair for temperature test.

Figure 29. For CX1105A, a range of accessories can be integrated for more efficient characterization and validation.

## User calibration maximizes the accuracy of your measurements

Aux Out is used in the calibration procedure for each channel connecting a sensors or a probe adapter. Since the connection cable and required calibration tools are included with the mainframe and sensors, you can benefit from the accuracy of User Calibration.








Figure 30. Aux Out for user calibration.

## Comparison Table for Available Sensors

These are supplemental information. For more detailed characteristics, please refer to the datasheet part of this document.

Table 3. Sensor comparison table

| Product description                                    |   | CX1101A single channel current sensor   | CX1102A dual channel current sensor   | CX1103A low-side 100 pA current sensor   | CX1104A selectable shunt current sensor   | CX1105A ultra-Low noise differential sensor   |
|--|---|---|---|--|---|---|
| Product image  |   |  |  |  |  |  |
| Current sensing technology                             |   | Composite current sensing   | Composite current sensing   | Low-noise transimpedance   | Optimized shunt resistor  | Ultra-low noise differential sensing  |
| Maximum standalone bandwidth                           |   | 100 MHz   | 100 MHz   | 200 MHz  | 20 MHz  | 100 MHz   |
| Maximum measurable current                             |   | 1 A (10 A)  | 1 A   | 20 mA  | 15 A  | 100 A (realistic max.)  |
| Minimum measurable current                             |   | 40 nA   | 40 nA   | 150 pA   | 1 μA  | 1 μA  |
| Dynamic range  |   | Over 80 dB  | Over 100 dB   | Over 80 dB   | Over 80 dB  | Over 80 dB  |
| Typical insertion resistance                           |   | 410 mΩ (50 Ω)   | 410 mΩ (50 Ω)   | 4 Ω (50 Ω)   | 5.5 mΩ to 1 Ω (6 selectable shunts)   | N/A (customer's shunt)  |
| Maximum common mode voltage                            |   | ± 40 V  | ± 12 V  | ± 0.5 V  | ± 40 V  | ± 40 V or ± 6 V   |
| Number of output channels                              |   | 1   | 2   | 1  | 1   | 1   |
| Measurement Side (High/Low/Both)                       |   | Both  | Both  | Low  | Both  | Both  |
| Current source for offset cancellation (See Figure 24) |   | No  | No  | Yes  | No  | No  |
| Application example                                    | Low power IoT device (BLE, ZigBee, etc.)        | √   | √   |  |   |   |
|  | Wearable device (watch, wrist band, etc.)       | √   | √   |  |   |   |
|  | Medical/healthcare device                       | √   | √   |  | √   | √   |
|  | Energy harvesting (IC, sensor, actuator, etc.)  | √   |   | √  |   |   |
|  | MCU/SoC for low power IoT device                | √   | √   |  | √   | √   |
|  | Low power IC and sensor (analog, digital)       | √   |   | √  |   |   |
|  | Middle power IoT device (WiFi, LTE, etc.)       |   |   |  | √   | √   |
|  | Device characterization (RRAM, PCM, MRAM, etc.) | √   |   | √  | √   |   |
|  | Device characterization (CMOS, WBG, etc.)       | √   |   | √  | √   |   |
|  | Mobile device (Smart phone, Tablet, etc.)       | √   |   |  | √   | √   |
|  | SoC/APU/MPU/GPU for mobile device               |   |   |  | √   | √   |
|  | FPGA/PLD  | √   |   |  | √   | √   |
|  | ECU and sensor for automotive                   | √   | √   |  | √   | √   |

## High input impedance digital channel minimizes load current in the probe (a CX3324A option)

The CX1152A Digital Channel is useful when you need up to 8 channels of digital triggers to measure current synchronized with digital signals such as controller's I/O or data bus. Unlike conventional digital probes, each probe for the CX1152A has large 10 M $\Omega$  input resistance, which enables you to make accurate low power measurements by minimizing the load current.

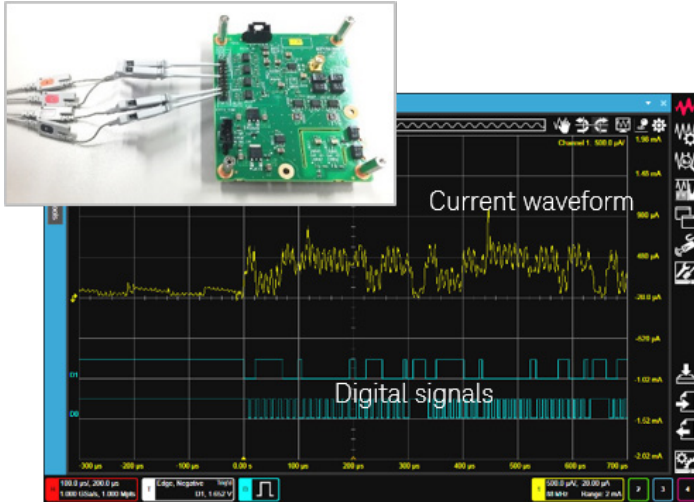


Figure 31. Current waveform measurement using a Digital Channel.

## Precision 14/16-bit voltage waveform measurements enables you to measure what was previously unmeasurable

With a CX1151A Passive Probe Interface Adapter, you can use a regular passive probe for regular voltage measurements. It enables you to make dynamic power measurements with a current sensor and also to make precision voltage waveform measurements in 14/16-bit resolution. As a result, you can also measure low-level voltage transients that were previously undetectable with noisy existing instruments.

## An upgradable mainframe allows you to own the most affordable CX3300 series without sacrificing future measurement needs

The CX3300 mainframe has the following options, allowing you to choose the best specifications according to your budget and application needs.

- A two-channel model (CX3322A) and a four-channel model (CX3324A) <sup>1</sup>
- Three maximum bandwidth options: 50 MHz, 100 MHz and 200 MHz
- Three memory depth options per channel: 16 Mpts, 64 Mpts and 256 Mpts

Upgrade licensed products are available to meet your application requirements for enhancing the bandwidth and the memory depth of the mainframe that you have previously purchased. Please see the "CX3300 Series Configuration Guide" in detail.



Figure 32. Example of voltage measurement using a passive probe.

1. Number of channels is not upgradeable.

# The Intuitive User Interface and Sophisticated Measurement/Analysis Capabilities Improve Measurement and Analysis Efficiency

In addition to common functions used in middle class oscilloscopes, the CX3300 series user interface provides advanced and easy-to-use measurement environment for current measurement applications. You can begin using the CX3300 series and make your critical dynamic current measurements quickly without having to study a complex manual. Convenient information such as effective measurement bandwidth, which is usually required for the wide dynamic range of current measurement, is also implemented for the use of any sensor/adaptor.

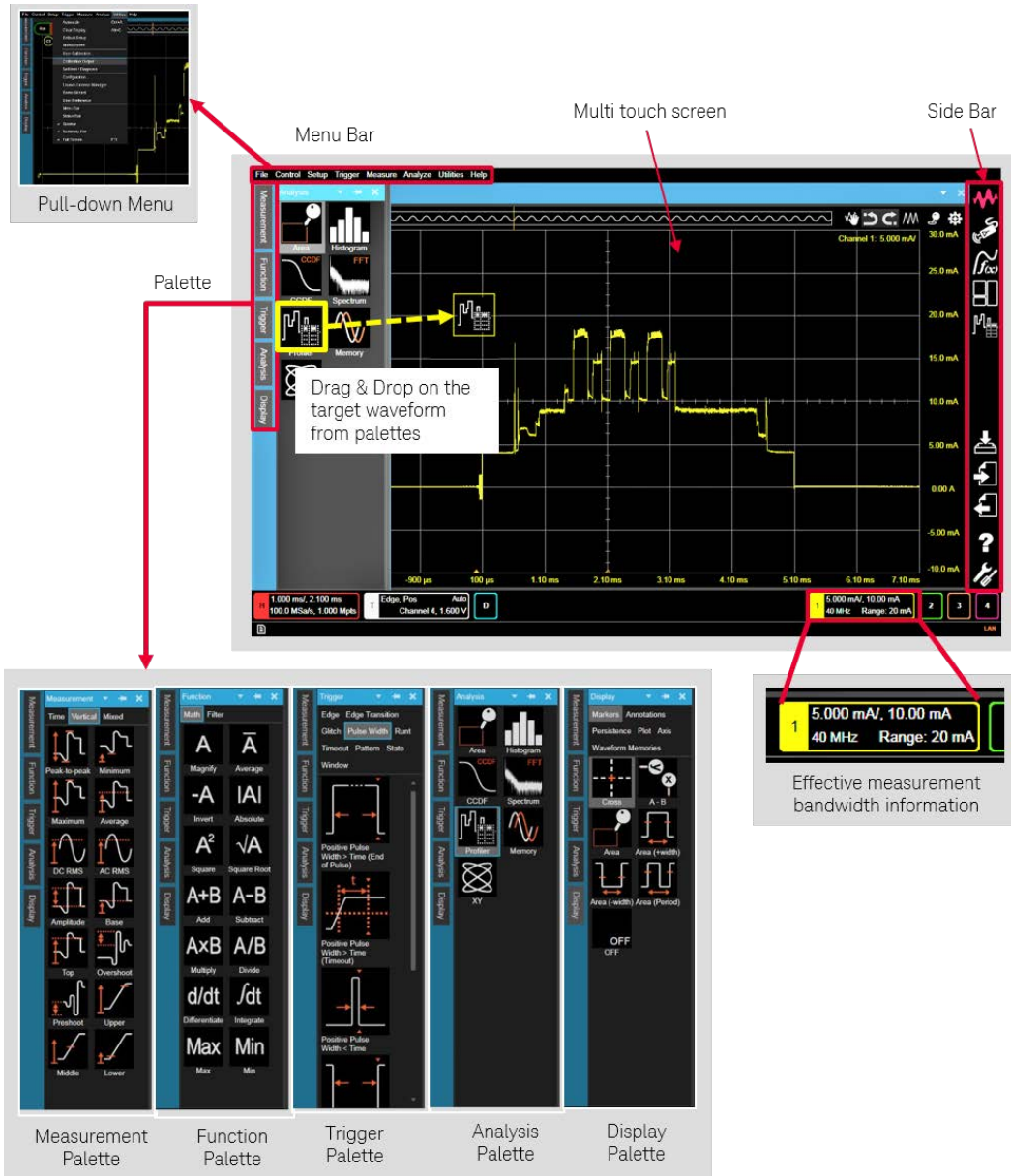
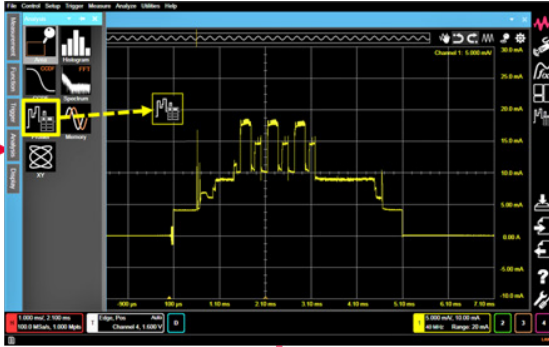


Figure 33. CX3300 series' user interface.

## Automatic Power and Current Profiler eliminates time-consuming power and current profile analysis

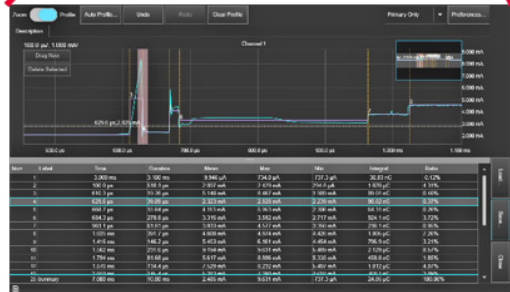
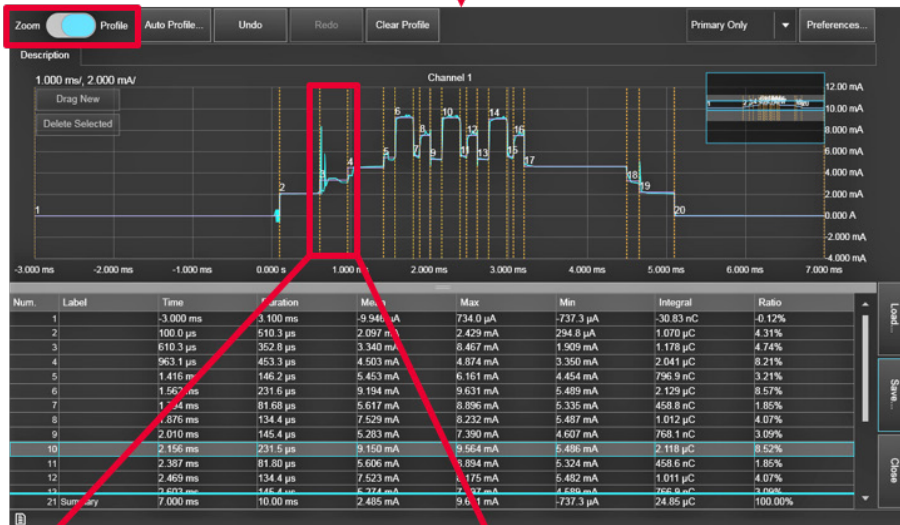
Analysis of power or current profile is essential in order to find out how much current is consumed at a certain event or status. However, this is a time-consuming process with the use of specific softwares on your external PC. The Power and Current Profiler, which is built in all the CX3300 series mainframes, automatically adjust the time scale by the vertical level difference, which can instantly calculate key parameters such as average current, max./min. current, accumulated charge, etc., and write them in the table underneath. You can also adjust the segment manually according to your measured profile.

Analysis palette



You can start the Power and Current Profiler by using the 'drag and drop' function with the Profiler icon on the target waveform. It automatically copies the captured waveform in the Profiler's window.

Switch between Zooming and Profiling



Using the Zoom function of the Profiler, you can add, remove and move lines easily and precisely. The table is instantly updated every time you modify the segment.

Figure 34. Automatic Power and Current Profiler.

## Auto Save function automatically captures and saves randomly appearing waveforms

The Auto Save function automatically detects irregular transients and saves them in the mainframe storage. After setting an appropriate trigger level and the maximum number of acquired waveform, you can start using Auto Save. Each waveform captured can be loaded in the main display for later analysis. Since there is no limitation for the number of captured waveforms, you can start the Auto Save function before leaving your test station and go through the results later.

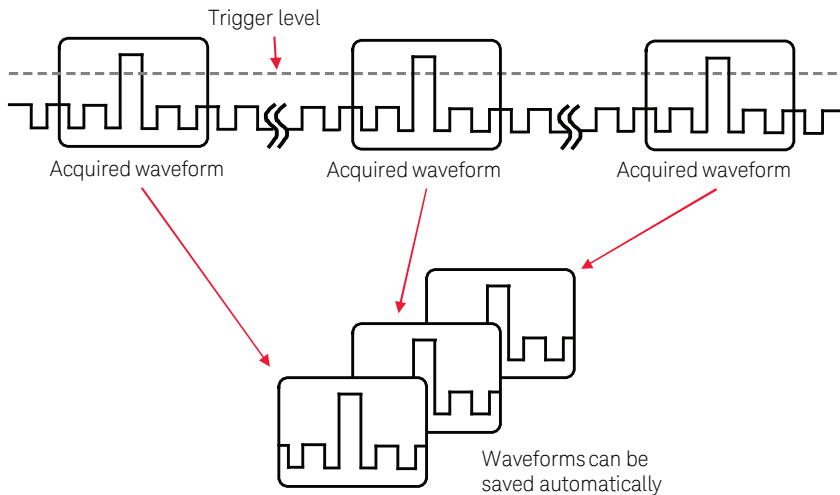


Figure 35. How the Auto Save works.

## Frequency domain analysis (FFT) of dynamic current provides additional information for your PDN characterization

FFT analysis can be used for current waveforms similar to voltage waveforms. Since the voltage transients at PDN are usually small, using relatively larger current waveforms would help you perform frequency domain analyses. As shown in Figure 36, using the gating functions helps you focus on the required period in the waveform.

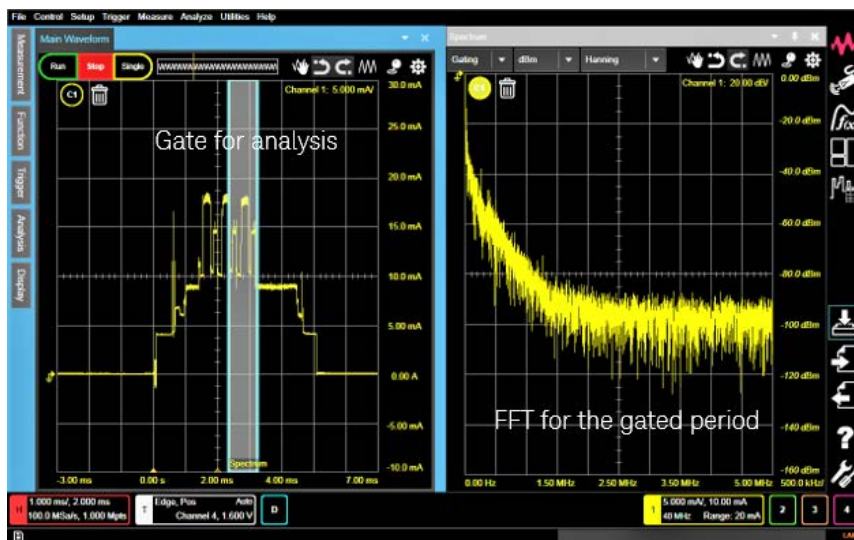


Figure 36. Frequency domain analysis (FFT).

## XY analysis expands what you can analyze with the CX3300 mainframe

Combining precision voltage waveform and precision current waveform in an XY analysis, you can gain more analysis capabilities. Figure 37 shows an XY analysis example when using a voltage ramp waveform to measure IV curve of an LED.

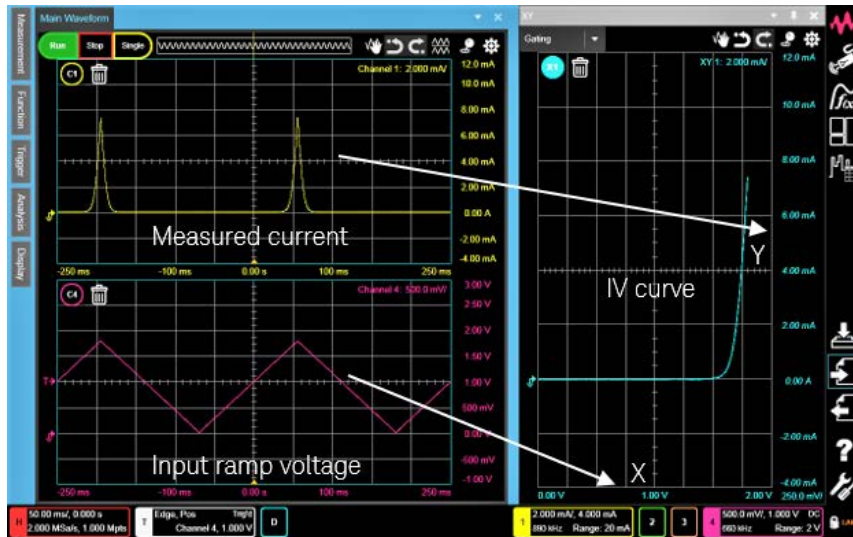


Figure 37. XY Analysis function.

## Area Marker gives you quick measurement results for your target behavior

Moving the expandable area cursor on the measured waveform, you can measure average current, RMS current, etc. in the designated area. This function is useful when you optimize the power consumption by focusing on a certain event.

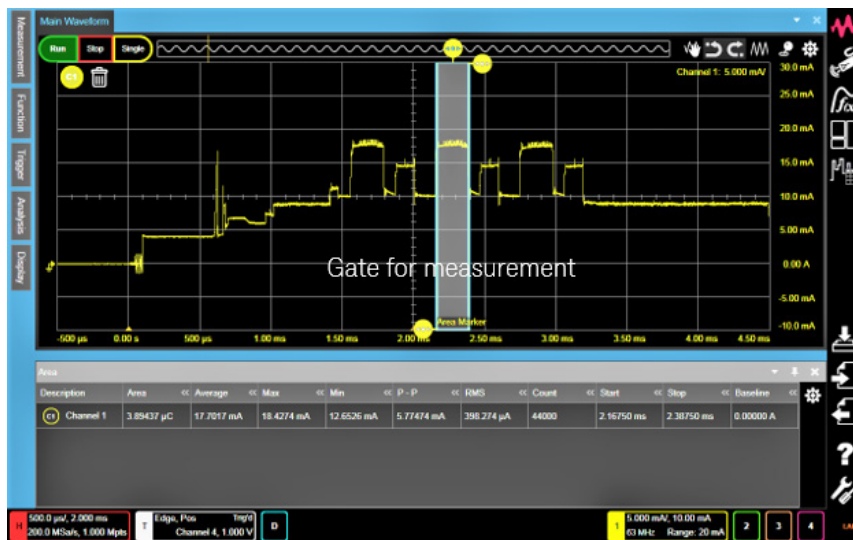


Figure 38. Area Marker function.



## Statistical analyses shorten your time to insight

CX3300 features statistical analyses such as Complementary Cumulative Distribution Function (CCDF) or histogram on the mainframe. As a result, you can focus on your measurement without having to transfer and format the data for another software on your PC.



Figure 39. Statistical analysis (CCDF).

## Easy and useful save and load for measured waveforms and analysis results

The CX3300 series provides a wide variety of ways to save data, screen capture and measurement setup using high speed interface such as USB or LAN. Please see the datasheet part of this document for more details. In addition, you can also save and load the segment as "Profile Lines" for the Automatic Power and Current Profiler as shown in Figure 40.

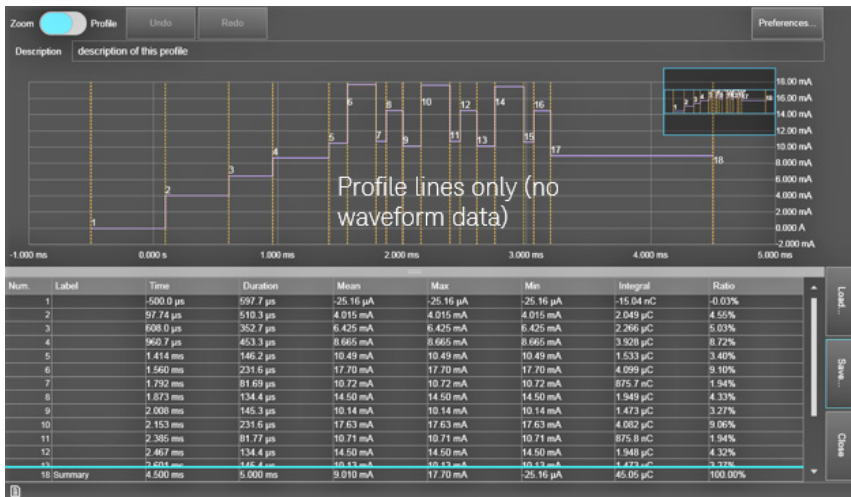


Figure 40. Loaded "Profile Lines" only in the Profiler.

## Easily automate testing by BenchVue software

Keysight Technologies' BenchVue software supports CX3300 series (BenchVue Current Analyzer application) and allows you to control your CX3300 series from a PC. Multiple Keysight instruments can be connected and controlled together with the CX3300 series, and the powerful and intuitive test sequence capability quickly creates automated tests over the connected instruments. The measurement results are easily logged, plotted on a graph and exported for your further analyses. Figure 41 is a test sequence example using a Keysight's 33622A Waveform Generator and a CX3324A to make a simple pulse measurement.



Figure 41. BenchVue Current Analyzer use example using a CX3324A and a 33622A.

## Key Characteristics

Table 4. CX3300 series mainframe key characteristics

| Models  | Input channel | Analog bandwidth options | Max. sample rate | Dynamic range (ADC bits)                           | Memory depth options               | Digital channel | User installed upgrade  |
|---------|---------------|--------------------------|------------------|--|------------------------------------|-----------------|-------------------------|
| CX3322A | 2             | 50 MHz, 100 MHz, 200 MHz | 1 GSa/s          | 14 (high speed mode) and 16 (high resolution mode) | 4 Mpts, 16 Mpts, 64 Mpts, 256 Mpts | No              | Bandwidth, memory depth |
| CX3324A | 4             | 50 MHz, 100 MHz, 200 MHz | 1 GSa/s          | 14 (high speed mode) and 16 (high resolution mode) | 4 Mpts, 16 Mpts, 64 Mpts, 256 Mpts | Yes             | Bandwidth, memory depth |

Table 5. Current sensors key characteristics

| Models               | Description                                      | RMS noise at 20 MHz NBW | Max. measurable current | DC measurement accuracy (with mainframe) <sup>1</sup> | Max. bandwidth (standalone) |
|----------------------|--|-------------------------|-------------------------|---|-----------------------------|
| CX1101A              | Current sensor, single channel                   | 40 nA                   | 10 A <sup>2</sup>       | ± (0.6 % + 0.3 %)                                     | 100 MHz                     |
| CX1102A <sup>3</sup> | Current sensor, dual channel                     | 40 nA                   | 1 A                     | ± (0.6 % + 0.3 %)                                     | 100 MHz                     |
| CX1103A              | Current sensor, low side                         | 150 pA                  | 20 mA                   | ± (0.6 % + 0.3 %)                                     | 200 MHz                     |
| CX1104A              | Current sensor, selectable resistive sensor head | 22 μA <sup>4</sup>      | 15 A                    | ± (1.7 % + 0.5 %)                                     | 20 MHz                      |
| CX1105A              | Differential sensor, single channel              | 20 μV <sup>5</sup>      | 100 A <sup>6</sup>      | ± (1.4 % + 0.3 %)                                     | 100 MHz                     |

1. Specification within 24 hours after executing user calibration. CX1104A is used with CX1214A.
2. With a CX1206A sensor head.
3. CX1102A occupies two input channels on the mainframe.
4. With a CX1216A resistive sensor head.
5. High resolution mode is enabled. Current noise depends on shunt resistor measured.
6. Realistic maximum measurable current.

## Current/differential sensors measurement range

Table 6. CX1101A Current Sensor, Single Channel,  $\pm 40$  V, 100 MHz, 40 nA to 1 A

| Channel     |                        | Maximum bandwidth (-3 dB) | Input resistance (Typical) | Maximum common mode voltage |
|-------------|------------------------|---------------------------|----------------------------|-----------------------------|
| Range       | RMS noise <sup>1</sup> |                           |                            |                             |
| 10 A        | 10 mA                  | 3 MHz <sup>2</sup>        | 15 m $\Omega$              |                             |
| 1 A         | 2 mA                   |                           |                            |                             |
| 200 mA      | 0.2 mA                 | 100 MHz                   | 410 m $\Omega$             |                             |
| 20 mA       | 20 $\mu$ A             |                           |                            |                             |
| 2 mA        | 3 $\mu$ A              |                           |                            | $\pm 40$ V                  |
| 200 $\mu$ A | 500 nA <sup>5</sup>    | 500 kHz <sup>5</sup>      |                            |                             |
|             | 400 nA <sup>3</sup>    | 25 kHz <sup>3</sup>       | 50 $\Omega$                |                             |
| 20 $\mu$ A  | 150 nA <sup>5</sup>    | 500 kHz <sup>5</sup>      |                            |                             |
|             | 40 nA <sup>3</sup>     | 25 kHz <sup>3</sup>       |                            |                             |

Table 7. CX1102A Current Sensor, Dual Channel,  $\pm 12$  V, 100 MHz, 40 nA to 1 A

| Primary channel    |                        | Secondary channel        |                        | Maximum bandwidth (-3 dB) | Input resistance (Typical) | Maximum common mode voltage |
|--------------------|------------------------|--------------------------|------------------------|---------------------------|----------------------------|-----------------------------|
| Range              | RMS noise <sup>1</sup> | Range                    | RMS noise <sup>1</sup> |                           |                            |                             |
| 1 A                | 2 mA                   | 20 mA                    | 20 $\mu$ A             | 100 MHz                   | 410 m $\Omega$             |                             |
| 200 mA             | 0.2 mA                 | 2 mA                     | 3 $\mu$ A              |                           |                            |                             |
| 20 mA              | 20 $\mu$ A             | 200 $\mu$ A              | 500 nA                 | 500 kHz                   |                            | $\pm 12$ V                  |
| 2 mA               | 2 $\mu$ A              | 20 $\mu$ A               | 200 nA                 |                           | 50 $\Omega$                |                             |
| 20 mA <sup>3</sup> | 8 $\mu$ A <sup>3</sup> | 200 $\mu$ A <sup>3</sup> | 400 nA <sup>3</sup>    | 90 kHz <sup>3</sup>       |                            |                             |
| 2 mA <sup>3</sup>  | 1 $\mu$ A <sup>3</sup> | 20 $\mu$ A <sup>3</sup>  | 40 nA <sup>3</sup>     | 25 kHz <sup>3</sup>       |                            |                             |

Table 8. CX1103A Current Sensor, Low Side, 200 MHz, 100 pA to 20 mA

| Channel     |                        | Maximum bandwidth (-3 dB) | Maximum offset current | Input resistance (Typical)         | Maximum common mode voltage         |
|-------------|------------------------|---------------------------|------------------------|------------------------------------|-------------------------------------|
| Range       | RMS noise <sup>1</sup> |                           |                        |                                    |                                     |
| 20 mA       | 5 $\mu$ A              | 200 MHz                   | $\pm 20$ mA            |                                    |                                     |
| 2 mA        | 1.5 $\mu$ A            | 75 MHz                    |                        |                                    |                                     |
| 200 $\mu$ A | 150 nA                 | 9 MHz                     | $\pm 200$ $\mu$ A      | 50 $\Omega$ (50 $\Omega$ Input ON) | $\pm 1$ V (50 $\Omega$ Input ON)    |
| 20 $\mu$ A  | 25 nA                  | 2.5 MHz                   |                        | 4 $\Omega$ (50 $\Omega$ Input OFF) | $\pm 0.5$ V (50 $\Omega$ Input OFF) |
| 2 $\mu$ A   | 1.5 nA                 | 250 kHz                   | $\pm 2$ $\mu$ A        |                                    |                                     |
| 200 nA      | 150 pA                 | 100 kHz                   |                        |                                    |                                     |

Table 9. CX1104A Current Sensor, Selectable Resistive Sensor Head

| Resistive sensor head | Range (upper/lower) | RMS noise (20 MHz NBW) | Maximum bandwidth (-3 dB) | Input resistance (Typical) | Maximum common mode voltage |
|-----------------------|---------------------|------------------------|---------------------------|----------------------------|-----------------------------|
| CX1211A               | 15.0 A              | 48 mA                  |                           | 5.5 m $\Omega$             |                             |
|                       | 10.0 A              | 8.8 mA                 |                           |                            |                             |
| CX1212A               | 10.0 A              | 24 mA                  |                           | 8.0 m $\Omega$             |                             |
|                       | 5.0 A               | 4.4 mA                 |                           |                            |                             |
| CX1213A               | 5.0 A               | 6.0 mA                 |                           | 23 m $\Omega$              |                             |
|                       | 1.25 A              | 1.1 mA                 | 20 MHz                    |                            | $\pm 40$ V                  |
| CX1214A               | 3.0 A               | 2.4 mA                 |                           | 53 m $\Omega$              |                             |
|                       | 500 mA              | 440 $\mu$ A            |                           |                            |                             |
| CX1215A               | 2.0 A               | 1.2 mA                 |                           | 103 m $\Omega$             |                             |
|                       | 250 mA              | 220 $\mu$ A            |                           |                            |                             |
| CX1216A               | 250 mA              | 120 $\mu$ A            |                           | 1.0 $\Omega$               |                             |
|                       | 25 mA               | 22 $\mu$ A             |                           |                            |                             |

Table 10. CX1105A Differential Sensor, Single Channel

| Range  | RMS noise  |                          | Maximum bandwidth (-3 dB) | Maximum common mode voltage |
|--------|------------|--------------------------|---------------------------|-----------------------------|
|        | 20 MHz NBW | 2.5 kHz NBW <sup>4</sup> |                           |                             |
| 2.5 V  | 1100 μV    | 200 μV                   | 100 MHz                   | ± 40 V                      |
| 1 V    | 1100 μV    | 200 μV                   |                           |                             |
| 250 mV | 45 μV      | 3.0 μV                   |                           |                             |
| 100 mV | 24 μV      | 1.3 μV                   |                           |                             |
| 25 mV  | 20 μV      | 400 nV                   |                           | ± 6 V                       |

1. Noise measurement bandwidth = 20 MHz
2. At -4 dB.
3. Built-in low pass filter mode is ON.
4. High resolution mode is enabled.
5. To enable these ranges, CX1101A's firmware version must be 2.0 or later.

## Effective current measurement bandwidth

In this datasheet, the maximum bandwidth of the mainframe (50 MHz, 100 MHz and 200 MHz), sensors (20 MHz, 100 MHz, 200 MHz) and probe adapter (300 MHz) is measured and defined as a “standalone” instrument.

As described in the data sheet part of this document, the “effective” measurement bandwidth when a current sensor or an adapter is connected to a mainframe can be estimated by the equation below.

Table 11a describes the effective measurement bandwidth for available combination with the 200 MHz mainframe.

$$BW_{\text{effective}} = \frac{1}{\sqrt{\frac{1}{BW_{\text{sensor}}^2} + \frac{1}{BW_{\text{mainframe}}^2}}}$$

Table 11a. Maximum effective measurement bandwidth

| Sensor/Adapter bandwidth $BW_{\text{sensor}}$ (MHz) | Mainframe bandwidth $BW_{\text{mainframe}}$ (MHz) | Effective measurement bandwidth (MHz) |
|---|---|---------------------------------------|
| CX1101A   | 200   | ~ 90                                  |
| CX1102A   |   | ~ 90                                  |
| CX1103A   |   | ~ 140                                 |
| CX1104A   |   | ~ 20                                  |
| CX1105A   |   | ~ 90                                  |
| CX1151A <sup>1</sup>                                |   | ~ 165                                 |

1. No passive probe is connected.

## Ordering Information

Table 11b. CX3300 series ordering information

| Category        | Model number | Description  |  |
|-----------------|--------------|--|--|
| Mainframe model | CX3322A      | Device Current Waveform Analyzer, 1 GSa/s, 14/16-bit, 2 Channel      |  |
|                 | CX3322A-B05  | Bandwidth – 50 MHz   |  |
|                 | CX3322A-B10  | Bandwidth – 100 MHz  |  |
|                 | CX3322A-B20  | Bandwidth – 200 MHz  |  |
|                 | CX3322A-004  | Memory – 4 Mpts/ch   |  |
|                 | CX3322A-016  | Memory – 16 Mpts/ch  |  |
|                 | CX3322A-064  | Memory – 64 Mpts/ch  |  |
|                 | CX3322A-256  | Memory – 256 Mpts/ch   |  |
|                 | CX3300A-KBD  | Mini-Keyboard and Optical Mouse                                      |  |
|                 | CX3322A-A6J  | ANZI Z540-1-1994 Calibration   |  |
|                 | CX3322A-UK6  | Commercial Calibration Certificate with Test Data                    |  |
|                 | CX3324A      | Device Current Waveform Analyzer, 1 GSa/s, 14/16-bit, 4 Channel      |  |
|                 | CX3324A-B05  | Bandwidth – 50 MHz   |  |
|                 | CX3324A-B10  | Bandwidth – 100 MHz  |  |
|                 | CX3324A-B20  | Bandwidth – 200 MHz  |  |
|                 | CX3324A-004  | Memory – 4 Mpts/ch   |  |
|                 | CX3324A-016  | Memory – 16 Mpts/ch  |  |
|                 | CX3324A-064  | Memory – 64 Mpts/ch  |  |
|                 | CX3324A-256  | Memory – 256 Mpts/ch   |  |
|                 | CX3300A-KBD  | Mini-Keyboard and Optical Mouse                                      |  |
|                 | CX3324A-A6J  | ANZI Z540-1-1994 Calibration   |  |
|                 | CX3324A-UK6  | Commercial Calibration Certificate with Test Data                    |  |
|                 | Sensor model | CX1101A  | Current Sensor, Single Channel, $\pm 40$ V, 100 MHz, 40 nA – 1 A |
|                 |              | CX1101A-A6J  | ANZI Z540-1-1994 Calibration                                     |
|                 |              | CX1101A-UK6  | Commercial Calibration Certificate with Test Data                |
| CX1102A         |              | Current Sensor, Dual Channel, $\pm 12$ V, 100 MHz, 40 nA - 1 A       |  |
| CX1102A-A6J     |              | ANZI Z540-1-1994 Calibration   |  |
| CX1102A-UK6     |              | Commercial Calibration Certificate with Test Data                    |  |
| CX1103A         |              | Current Sensor, Low Side, 200 MHz, 100 pA - 20 mA                    |  |
| CX1103A-A6J     |              | ANZI Z540-1-1994 Calibration   |  |
| CX1103A-UK6     |              | Commercial Calibration Certificate with Test Data                    |  |
| CX1104A         |              | Current Sensor, Selectable Resistive Sensor Head, $\pm 40$ V, 20 MHz |  |
| CX1104A-A6J     |              | ANZI Z540-1-1994 Calibration   |  |
| CX1104A-UK6     |              | Commercial Calibration Certificate with Test Data                    |  |
| CX1105A         |              | Differential Sensor, Single Channel, 100 MHz                         |  |
| CX1105A-A6J     |              | ANZI Z540-1-1994 Calibration   |  |
| CX1105A-UK6     |              | Commercial Calibration Certificate with Test Data                    |  |
| Adapter         |              | CX1151A <sup>1</sup>   | Passive Probe Interface Adapter                                  |
|                 |              | CX1151A-A6J  | ANZI Z540-1-1994 Calibration                                     |
|                 | CX1151A-UK6  | Commercial Calibration Certificate with Test Data                    |  |
| Digital channel | CX1152A      | Digital Channel, 10 MOhm Input, $\pm 25$ V, 8 Channel                |  |
| Other accessory | CX1903A      | Rack Mount Kit for CX3300 Series                                     |  |
|                 | CX1905B      | Attachment for 3D Probe Positioner                                   |  |

Table 11b. CX3300 series ordering information (Continued)

| Category                            | Model number                                       | Description   |
|-------------------------------------|--|---|
| Sensor Head for CX1101A and CX1102A | CX1201A  | Sensor Head, Coaxial Through                          |
|                                     | CX1202A  | Sensor Head, Coaxial Through with V Monitor           |
|                                     | CX1203A <sup>2</sup>                               | Sensor Head, Coaxial Termination                      |
|                                     | CX1204A  | Sensor Head, Twisted Pair Adapter                     |
|                                     | CX1205A  | Sensor Head, Test Lead Adapter                        |
|                                     | CX1206A  | Sensor Head, High Current Adapter with Expander, 10 A |
| Resistive Sensor Head for CX1104A   | CX1211A  | Resistive Sensor Head, 15 A, 5.5 mΩ                   |
|                                     | CX1211A-A6J  | ANZI Z540-1-1994 Calibration                          |
|                                     | CX1211A-UK6  | Commercial Calibration Certificate with Test Data     |
|                                     | CX1212A  | Resistive Sensor Head, 10 A, 8 mΩ                     |
|                                     | CX1212A-A6J  | ANZI Z540-1-19094 Calibration                         |
|                                     | CX1212A-UK6  | Commercial Calibration Certificate with Test Data     |
|                                     | CX1213A  | Resistive Sensor Head, 5 A, 23 mΩ                     |
|                                     | CX1213A-A6J  | ANZI Z540-1-1994 Calibration                          |
|                                     | CX1213A-UK6  | Commercial Calibration Certificate with Test Data     |
|                                     | CX1214A  | Resistive Sensor Head, 3 A, 53 mΩ                     |
|                                     | CX1214A-A6J  | ANZI Z540-1-1994 Calibration                          |
|                                     | CX1214A-UK6  | Commercial Calibration Certificate with Test Data     |
|                                     | CX1215A  | Resistive Sensor Head, 2 A, 103 mΩ                    |
|                                     | CX1215A-A6J  | ANZI Z540-1-1994 Calibration                          |
|                                     | CX1215A-UK6  | Commercial Calibration Certificate with Test Data     |
|                                     | CX1216A  | Resistive Sensor Head, 0.25 A, 1 Ω                    |
| CX1216A-A6J                         | ANZI Z540-1-1994 Calibration                       |   |
| CX1216A-UK6                         | Commercial Calibration Certificate with Test Data  |   |
| Windows 10 upgrade Product          | CX3322AU   | Upgrade Kit for CX3322A                               |
|                                     | CX3322AU-W10                                       | OS upgrade from Windows7 to Windows10                 |
|                                     | CX3324AU   | Upgrade kit for CX3324A                               |
|                                     | CX3324AU-W10                                       | OS upgrade from Windows7 to Windows10                 |
| Bandwidth upgrade Product           | CX1601U  | Bandwidth upgrade from 50 MHz to 100 MHz for CX3322A  |
|                                     | CX1602U  | Bandwidth upgrade from 50 MHz to 200 MHz for CX3322A  |
|                                     | CX1603U  | Bandwidth upgrade from 100 MHz to 200 MHz for CX3322A |
|                                     | CX1611U  | Bandwidth upgrade from 50 MHz to 100 MHz for CX3324A  |
|                                     | CX1612U  | Bandwidth upgrade from 50 MHz to 200 MHz for CX3324A  |
|                                     | CX1613U  | Bandwidth upgrade from 100 MHz to 200 MHz for CX3324A |
| Memory Depth upgrade Product        | CX1651U  | Memory upgrade from 16 Mpts to 64 Mpts for CX3322A    |
|                                     | CX1652U  | Memory upgrade from 16 Mpts to 256 Mpts for CX3322A   |
|                                     | CX1653U  | Memory upgrade from 64 Mpts to 256 Mpts for CX3322A   |
|                                     | CX1654U  | Memory upgrade from 4 Mpts to 16 Mpts for CX3322A     |
|                                     | CX1655U  | Memory upgrade from 4 Mpts to 64 Mpts for CX3322A     |
|                                     | CX1656U  | Memory upgrade from 4 Mpts to 256 Mpts for CX3322A    |
|                                     | CX1661U  | Memory upgrade from 16 Mpts to 64 Mpts for CX3324A    |
|                                     | CX1662U  | Memory upgrade from 16 Mpts to 256 Mpts for CX3324A   |
|                                     | CX1663U  | Memory upgrade from 64 Mpts to 256 Mpts for CX3324A   |
|                                     | CX1664U  | Memory upgrade from 4 Mpts to 16 Mpts for CX3324A     |
| CX1665U                             | Memory upgrade from 4 Mpts to 64 Mpts for CX3324A  |   |
| CX1666U                             | Memory upgrade from 4 Mpts to 256 Mpts for CX3324A |   |

1. Recommended passive probe: Keysight N2843A.

2. CX1203A is furnished for CX1101A and CX1102A.

## CX3300 Series Characteristics

Warranted specifications are denoted by \*\*, and all others are supplemental characteristics. Specifications are valid after a 30-minute warm-up and  $23 \pm 5$  °C.

### Measurement accuracy

Measurement accuracy can be affected by RF electro-magnetic field having the strengths greater than 3 V/m in the frequency range of 80 MHz to 2 GHz or 1 V/m in the frequency range of 2 GHz to 2.7 GHz. The extent of this effect depends upon how the instrument is positioned and shielded.

Table 12. CX3300 series mainframe characteristics overview

|                            |         | Description  |
|----------------------------|---------|--|
| Analog bandwidth           |         | 50 MHz (Option B05), 100 MHz (Option B10), 200 MHz (Option B20)                        |
| Number of analog channels  | CX3322A | 2  |
|                            | CX3324A | 4  |
| Number of digital channels | CX3322A | N/A  |
|                            | CX3324A | 8 with CX1152A   |
| Vertical resolution        |         | 14-bit (High speed mode), 16-bit (High resolution mode)                                |
| Maximum sampling rate      |         | 1 GHz full channel   |
| Memory depth per channel   |         | 4 Mpts (Option 004), 16 Mpts (Option 016), 64 Mpts (Option 064), 256 Mpts (Option 256) |

Table 13. Vertical system - analog channels <sup>1</sup>

| Analog bandwidth (-3 dB)              | 14-bit resolution   | 50 MHz         | 100 MHz        | 200 MHz        |
|---------------------------------------|---|----------------|----------------|----------------|
|                                       | 16-bit resolution   | 14 MHz         | 14 MHz         | 14 MHz         |
| Input coupling                        | DC  |                |                |                |
| Input impedance **                    | 50 Ω: $\pm 3.5\%$   |                |                |                |
| Input range                           | $\pm 0.65$ V nominal, $\pm 2$ V peak                        |                |                |                |
| Vertical hardware resolution          | 14 bits or 16 bits  |                |                |                |
| DC measurement accuracy **            | $\pm (0.7\% \text{ of reading} + 0.7\% \text{ of range})^2$ |                |                |                |
| RMS noise ( $\pm 0.5$ V fix, full BW) | 14-bit resolution   | 120 $\mu$ Vrms | 170 $\mu$ Vrms | 250 $\mu$ Vrms |
|                                       | 16-bit resolution   | 46 $\mu$ Vrms  | 46 $\mu$ Vrms  | 46 $\mu$ Vrms  |

1. Analog channels only work with CX1100 series of sensors and CX1151A adapter and do not allow to be used for other purposes.

2. ADC Offset user calibration required.

Table 14. Horizontal system

|                      | Description             |
|----------------------|-------------------------|
| Main time base range | 1 ns/div to 20 s/div    |
| Resolution           | 1 ns                    |
| Modes                | Main                    |
| Reference position   | Left, center, right     |
| Time scale accuracy  | 10 ppm                  |
| Channel deskew       | Range = -100 to +100 ns |

Table 15. Acquisition - analog channels

|  | Description  |                           |
|--|--|---------------------------|
| Maximum real time sample rate <sup>1</sup> | 14 bit resolution  | 1 GSa/s for each channel  |
|  | 16 bit resolution  | 75 MSa/s for each channel |
| Standard memory depth                      | 4 Mpts per channel (Option 004)  |                           |
| Memory depth options                       | Option 016: 16 Mpts per channel  |                           |
|  | Option 064: 64 Mpts per channel  |                           |
|  | Option 256: 256 Mpts per channel   |                           |
| Sampling modes                             | Real time with average (Normal)  |                           |
|  | Real time with discard   |                           |
|  | Real time with peak detect   |                           |
| Filters                                    | sin (x) / x interpolation  |                           |
|  | Averaging  |                           |
|  | 1 MHz, 2 MHz, 5 MHz, 10 MHz, 20 MHz, 50 MHz (Option B10, B20), 100 MHz (Option B20) <sup>2</sup> |                           |
|  | Low frequency noise suppression mode (High resolution mode only)                                 |                           |

1. 14-bit and 16-bit can be toggled by pressing "High Reso" button. All channels are set to the same resolution.

2. Per channel filters characterized by Math functions.



Table 16. Acquisition - digital channels - CX3324A only

|   | Description |
|---|-------------|
| Maximum real time sample rate                 | 500 MSa/s   |
| Maximum memory depth per channel <sup>1</sup> | 128 Mpts    |
| Minimum width glitch detect                   | 7 ns        |

1. The memory depth depends on that of analog channels.

Table 17. Trigger

|                        | Description   |
|------------------------|---|
| Source                 | CX3322A<br>CX3324A  |
|                        | Ch 1, 2, aux and line<br>Ch 1, 2, 3, 4, aux, line and digital channels  |
| Sensitivity            | Analog channel: 5% of Sensor range<br>Digital channel: See CX1152A characteristics<br>External Trigger Input: DC to 100 MHz (minimum input: Vpp = 300 mV)   |
| Trigger level range    | Analog channel: $\pm$ Sensor range <sup>1</sup><br>Digital channel: see CX1152A<br>External trigger input: $\pm$ 8 V (1 M $\Omega$ )<br>External trigger output: 2.5 V (50 $\Omega$ , 100 ns pulse width) |
| Trigger coupling       | Analog channel<br>External trigger input  |
|                        | DC: High frequency reject (50 kHz low pass filter)<br>DC, or AC: (10 Hz) low frequency reject (50 kHz high pass filter), high frequency reject (50 kHz low pass filter)                                   |
| Sweep modes            | Auto, triggered, single   |
| Trigger hold off range | 100 ns to 10 s  |
| Trigger actions        | Specify an action to occur (and the frequency of the action) when a trigger condition occurs.   |

1. Trigger level range for analog channels is the same as the sensor range connected to mainframe.  $\pm$  Sensor range =  $\pm$  4 div. at default setting.

Table 18. Trigger modes

|  | Description  |
|--|--|
| Edge (analog and digital)                | Rising, Falling, Either  |
| Edge transition (analog)                 | Rising edge > Time, Rising edge < Time, Falling edge > Time, Falling edge < Time   |
| Glitch (analog and digital)              | Positive glitch > Time, Positive glitch < Time, Positive glitch in range, Negative glitch > Time, Negative glitch < Time, Negative glitch in range                                 |
| Pulse width (analog and digital)         | Positive pulse width > Time, Positive pulse width > Timeout, Positive pulse width < Time, Negative pulse width > Time, Negative pulse width > Timeout, Negative pulse width < Time |
| Runt (analog)                            | Positive runt, Positive runt (time qualified), Negative runt, Negative runt (time qualified)   |
| Timeout (analog and digital)             | High too long, Low too long, Unchanged too long  |
| Pattern/pulse range (analog and digital) | Pattern entered, Pattern exited, Pattern present > Time, Pattern present > Timeout, Pattern present < Time, Pattern present in range   |
| State (analog and digital)               | Rising edge (AND), Rising edge (NAND), Falling edge (AND), Falling edge (NAND), Either edge (AND), Either edge (NAND)  |
| Window (analog)                          | Entering range, Exiting range, Inside range > Time, Inside range > Timeout, Inside range < Time, Outside range > Time, Outside range > Timeout, Outside range < Time               |

Table 19. Measurements and analysis

|                            | Description  |
|----------------------------|--|
| Waveform measurements      | Can be made on either main or zoom region. Up to 8 simultaneous measurements.  |
| Amplitude                  | Peak-to-Peak, Minimum, Maximum, Average, DC RMS, AC RMS, Amplitude, Base, Top, Overshoot, Preshoot, Upper, Middle, Lower   |
| Time                       | Rise time, Fall time, Positive width, Negative width, Period, Frequency, Duty cycle, Tmin, Tmax  |
| Mixed                      | Slew rate, Area  |
| Math functions             | Can operate on any combination of channels, memories, or other functions. Up to 8 independent functions.   |
| Operators                  | Add, Subtract, Multiply, Divide, Absolute value, Average, Delay, Invert, Magnify, Max, Min, Differentiate, Integrate, Square, Square root<br>High pass filter, Low pass filter, Smoothing filter |
| Waveform memory            | Can be used for Measurements, Math functions and Analyses. Up to 8 independent memories.   |
| Markers                    | Cross hair, A-B, Area  |
| Statistics analysis        | Mean, Min, Max, Std dev. for waveform and waveform measurements  |
| Amplitude analysis         | Histogram (Hits, PDF, CDF, CCDF) and Statistics with windowing   |
| Spectrum analysis (FFT)    | Magnitude and Phase with horizontal gating, up to 1 Mpts   |
| X-Y analysis               | Up to 1 Mpts   |
| Power measurement wizard   |  |
| Power and current profiler |  |

Table 20. Visualization

|               | Description  |
|---------------|--|
| View          | Waveform, Histogram, Spectrum, Statistics, Setup summary, Side bar   |
| Display style | Single, Dual, Single plus Zoom (Vertical, Horizontal, Both)<br>Persistence, Color grade<br>Plot: Auto, Dots, Lines, Area, Gradation, Diamonds<br>Axis: Auto, Linear, Log, Invert |
| Annotation    | Can be inserted into display area and on specified waveform  |

Table 21. Save and load

|                             | Description   |
|-----------------------------|---|
| Screen capture <sup>1</sup> | JPG, BMP, PNG   |
| Trigger setup               | HDF5  |
| Setup                       | HDF5 (contains all setup including trigger setup)                           |
| Waveform                    | HDF5 (Save and Load) and CSV <sup>1</sup>                                   |
| Composite                   | HDF5 (contains setup, waveforms, measurement results, and analysis results) |
| Report                      | XPS (contains measurement results and analysis results) <sup>1</sup>        |
| Auto save                   |   |

1. Save only.

Table 22. Computer system and peripherals, I/O ports

|                                 |                                    | Description  |
|---------------------------------|------------------------------------|--|
| Display                         |                                    | WXGA 14.1" capacitive multi touch screen   |
| Resolution                      |                                    | Application runs with 1280 pixels horizontally x 800 pixels vertically   |
| Computer system and peripherals | Operating system                   | Windows 10 IoT   |
|                                 | CPU                                | 3 GHz Intel i5 quad core   |
|                                 | PC system memory                   | 8 GB RAM   |
|                                 | Drives                             | ≥ 250 GB removable SSD (solid state drive)   |
|                                 | Peripherals                        | Optical USB mouse and compact keyboard supplied. All models support any Windows compatible input device with a USB interface |
| I/O Ports                       | LAN                                | LAN RJ-45 connector, supports 10Base-T, 100Base-T, and 1000Base-T. Enables Web-enabled remote control                        |
|                                 | USB <sup>1</sup>                   | 7 total ports:   |
|                                 |                                    | Three USB 2.0 ports on the front   |
|                                 |                                    | Four USB ports on the side (two are USB 3.0 and two are USB 2.0)   |
|                                 | External display                   | Drivers support up to two simultaneous displays.<br>DisplayPort and VGA video out  |
|                                 | Auxiliary output                   | ± 7 V max., ± 200 mA max.: DC, Pulse, Square   |
|                                 | Time base reference output         | 10 MHz, 8.33 dBm (Vpp = 1.65 V) into 50 Ω  |
|                                 | Time base external reference input | 10 MHz, 16 dBm (Vpp = 4 V) max. into 50 Ω  |
|                                 | LXI compliance                     | LXI 1.4 Core, LXI HiSLIP, LXI IPv6   |

1. USB communication functionality can be affected by RF electro-magnetic field having the strengths greater than 3 V/m in the frequency range of 80 MHz to 2 GHz or 1 V/m in the frequency range of 2 GHz to 2.7 GHz. The extent of this effect depends upon how the instrument is positioned and shielded.

Table 23. Environmental and general

|   |                      | Description   |
|---|----------------------|---|
| Temperature                             | Operating            | 0 to 40 °C  |
|   | Storage              | -20 to 60 °C  |
| Humidity                                | Operating            | Up to 80% relative humidity (non-condensing) at 40 °C |
|   | Storage              | Up to 90% relative humidity (non-condensing) at 60 °C |
| Altitude                                | Operating            | Up to 2000 meters                                     |
|   | Storage              | Up to 4600 meters                                     |
| Power                                   |                      | 100 V to 240 V ± 10%, 50 Hz/60 Hz                     |
|   | Max power dissipated | 250 VA  |
| Weight                                  |                      | Mainframe: 11 kg                                      |
| Dimensions (with feet retracted)        |                      | 425.6 mm (W), 266.1 mm (H), 196.7 mm (D)              |
| Safety                                  |                      | IEC 61010-1   |
| Electromagnetic compatibility standards |                      | IEC 61326-1   |

# CX1100 Series Current/Differential Sensors Characteristics

Warranted specifications are denoted by \*\*, and all others are supplemental characteristics. Specifications are valid after a 30-minute warm-up and  $23 \pm 5$  °C. All these characteristics are defined by the 14-bit acquisition resolution of the CX3300 mainframe unless otherwise stated. See “Device Current Waveform Analyzer” data sheet (publication number: 5992-1430EN) for the mainframe characteristics.

## Overview of measurement accuracy

Measurement accuracy can be affected by RF electro-magnetic field having the strengths greater than 3 V/m in the frequency range of 80 MHz to 2 GHz or 1 V/m in the frequency range of 2 GHz to 2.7 GHz. The extent of this effect depends upon how the instrument is positioned and shielded.

## CX1101A Characteristics

Table 24. CX1101A characteristics overview

|                                  | Range  | $R_{IN}^2$         | Noise (rms) <sup>3</sup> | Maximum bandwidth (-3 dB) <sup>4</sup> |
|----------------------------------|--------|--------------------|--------------------------|--|
| Current measurement <sup>1</sup> | 10 A   | 15 mΩ (typ)        | 10 mA                    | 3 MHz <sup>5</sup>                     |
|                                  | 1 A    |                    | 2 mA                     | 100 MHz                                |
|                                  | 200 mA | 410 mΩ (typ)       | 0.2 mA                   | 100 MHz                                |
|                                  | 20 mA  | 550 mΩ (max)       | 20 μA                    | 100 MHz                                |
|                                  | 2 mA   |                    | 3 μA                     | 100 MHz                                |
|                                  | 200 μA |                    | 500 nA <sup>7</sup>      | 500 kHz <sup>7</sup>                   |
|                                  |        | 50 Ω (typ)         | 400 nA <sup>6</sup>      | 25 kHz                                 |
|                                  | 20 μA  | 77 Ω (max)         | 150 nA <sup>7</sup>      | 500 kHz <sup>7</sup>                   |
|                                  |        | 40 nA <sup>6</sup> | 25 kHz                   |  |

1. Sensor Head used to measure the characteristics: CX1206A for 10 A range and CX1203A for all other ranges.
2. The slide switch of CX1203A to be set to “0 Ω”.
3. 20 MHz noise bandwidth measured with mainframe.
4. Standalone bandwidth. The effective measurement bandwidth when connected to mainframe can be estimated by the following equation.

$$BW_{\text{effective}} = \frac{1}{\sqrt{\left(\frac{1}{BW_{\text{sensor}}}\right)^2 + \left(\frac{1}{BW_{\text{mainframe}}}\right)^2}}$$

5. -4 dB bandwidth.
6. The sensor built-in low pass filter is ON.
7. To enable these ranges, the CX1101A’s firmware version must be 2.0 or later.

Table 25. CX1101A DC measurement accuracy<sup>1</sup>

| Range  |   | Standalone                    | With mainframe                  | $T_{\text{USERCAL}} \pm 3$ °C, 24 hrs <sup>2</sup> |
|--------|---|-------------------------------|---------------------------------|--|
|        |   | $23 \pm 5$ °C                 | $23 \pm 5$ °C                   |  |
| 10 A   |   | $\pm (5\% + 5\%)$             | $\pm (5.7\% + 5.9\%)$           | N/A  |
| 1 A    |   | $\pm (2\% + 2\%)^{**}$        | $\pm (2.7\% + 2.9\%)^{**}$      | $\pm (1.8\% + 0.4\%)$                              |
| 200 mA | Gain [% of readings] +<br>Offset [% of range] | $\pm (2\% + 2\%)^{**}$        | $\pm (2.7\% + 2.9\%)^{**}$      | $\pm (0.7\% + 0.4\%)$                              |
| 20 mA  |   | $\pm (2\% + 2\%)^{**}$        | $\pm (2.7\% + 2.9\%)^{**}$      | $\pm (0.6\% + 0.3\%)$                              |
| 2 mA   |   | $\pm (2\% + \text{N/A})^{**}$ | $\pm (2.7\% + \text{N/A})^{**}$ | $\pm (0.7\% + 1.1\%)$                              |
| 200 μA |   | $\pm (2\% + 2\%)^{**}$        | $\pm (2.7\% + 2.9\%)^{**}$      | $\pm (0.7\% + 0.3\%)$                              |
| 20 μA  |   | $\pm (2\% + \text{N/A})^{**}$ | $\pm (2.7\% + \text{N/A})^{**}$ | $\pm (0.7\% + 1.1\%)$                              |

1. Accuracy is defined at  $V_{CM} = 0$  V (zero Common Mode input voltage at either  $+I_{IN}$  or  $-I_{IN}$ ). Add 0.7% typical to Offset error for  $V_{cm}$  up to 40 V. The “reading” is defined as measured value. DC measurement condition: 20 ms averaged.
2. After executing the User Calibration (both gain and offset) with mainframe.

Table 26. CX1101A other characteristics

|  |                                   |                         |
|--|-----------------------------------|-------------------------|
| Rise time (10% to 90%)                           | 0.35 / bandwidth                  |                         |
| Input common mode impedance <sup>1</sup>         | 750 M $\Omega$ // 31 pF (Nominal) |                         |
| Measurable over range                            | 10% of range                      |                         |
| Burden voltage                                   | $R_{IN}$ * Measured current       |                         |
| Maximum input voltage (common mode) <sup>2</sup> | Peak voltage (DC + AC) limit      | $\pm$ 40 V              |
|  | AC voltage limit                  | $\pm$ 5 V above 1 MHz   |
| Absolute maximum input current                   | Range                             | Protection <sup>4</sup> |
|  | 10 A                              | 11 A                    |
|  | 1 A                               |                         |
|  | 200 mA                            | 1.5 A <sup>3</sup>      |
|  | 20 mA                             |                         |
|  | 2 mA                              |                         |
| 200 $\mu$ A                                      | 50 mA                             |                         |
| 20 $\mu$ A                                       |                                   |                         |

1. Measured with a CX1201A. Both inputs has this same input impedance. When using a CX1203A Sensor Head, the minus (-) terminal is internally connected to the circuit common through a 10 M $\Omega$  resistor.
2. For all current measurement ranges.
3. CX1203A with 50  $\Omega$  setting: 125 mA.
4. See "CX1100 User's Guide" (CX1100-90000) for more information.

Table 27. CX1101A general information <sup>1</sup>

|                               | Description   |
|-------------------------------|---|
| Cable length                  | Sensor cable: 1.5 m, GND lead: 16 cm  |
| Dimension <sup>2</sup>        | 46.8 mm (W), 31.9 mm (H), 205.3 mm (D)                                      |
| Weight                        | 400 g   |
| Furnished accessories         | 1 each Coaxial Termination Adapter Sensor Head (CX1203A)                    |
|                               | 1 each Coaxial Cable, SMA plug to open, 100 mm (8121-2773) <sup>3</sup>     |
|                               | 1 each Coaxial Cable, SMA plug to MHF plug, 100 mm (8121-2774) <sup>3</sup> |
|                               | 1 each MHF pullin tool (8710-2791) <sup>3</sup>                             |
|                               | 5 each Coaxial Cable, MHF plug, shorted, 21 mm (8121-2780) <sup>3</sup>     |
|                               | 5 each RF Connector, MHF jack straight SMT (1250-3656) <sup>3</sup>         |
|                               | 1 each SMA(P) to BNC(J) 50 $\Omega$ Coaxial Adapter (1250-3975)             |
| 1 each GND lead (C1101-61711) |   |

1. Refer to mainframe's "Environmental and general" part for other information.
2. CX1203A Sensor Head is included. Cable and adapter are not included.
3. CX1203A's accessories.

# CX1102A Characteristics

Table 28. CX1102A characteristics overview

|                                  | Range           |                   | $R_{IN}^2$               | Noise (rms) <sup>3</sup>   |                               | Maximum bandwidth (-3 dB) <sup>4</sup> |
|----------------------------------|-----------------|-------------------|--------------------------|----------------------------|-------------------------------|--|
|                                  | Primary channel | Secondary channel |                          | Primary channel            | Secondary channel             |  |
| Current measurement <sup>1</sup> | 1 A             | 20 mA             | 410 mΩ (typ)             | 2 mA                       | 20 μA                         | 100 MHz                                |
|                                  | 200 mA          | 2 mA              | 550 mΩ (max)             | 0.2 mA                     | 3 μA                          |  |
|                                  | 20 mA           | 200 μA            | 50 Ω (typ)<br>77 Ω (max) | 20 μA<br>8 μA <sup>5</sup> | 500 nA<br>400 nA <sup>5</sup> | 500 kHz<br>90 kHz <sup>5</sup>         |
|                                  | 2 mA            | 20 μA             | 50 Ω (typ)<br>77 Ω (max) | 2 μA<br>1 μA <sup>5</sup>  | 200 nA<br>40 nA <sup>5</sup>  | 500 kHz<br>25 kHz <sup>5</sup>         |

1. Sensor Head used to measure the characteristics: CX1203A.
2. The slide switch of CX1203A to be set to “0 Ω”.
3. 20 MHz noise bandwidth measured with mainframe.
4. Standalone bandwidth. The effective measurement bandwidth when connected to mainframe can be estimated by the following equation.

$$BW_{\text{effective}} = \frac{1}{\sqrt{\left(\frac{1}{BW_{\text{sensor}}}\right)^2 + \left(\frac{1}{BW_{\text{mainframe}}}\right)^2}}$$

5. The sensor built-in low pass filter is ON.

Table 29. CX1102A DC measurement accuracy<sup>1</sup>

| Range            |                               | Standalone                    | With mainframe                  | $T_{\text{USERCAL}} \pm 3^\circ\text{C}, 24 \text{ hrs}^2$ |
|------------------|-------------------------------|-------------------------------|---------------------------------|--|
|                  |                               | $23 \pm 5^\circ\text{C}$      | $23 \pm 5^\circ\text{C}$        |  |
| 1 A primary      |                               | $\pm (2\% + 2\%)^{**}$        | $\pm (2.7\% + 2.9\%)^{**}$      | $\pm (1.8\% + 0.4\%)$                                      |
| 200 mA primary   |                               | $\pm (2\% + 2\%)^{**}$        | $\pm (2.7\% + 2.9\%)^{**}$      | $\pm (0.6\% + 0.4\%)$                                      |
| 20 mA secondary  |                               | $\pm (2\% + 2\%)^{**}$        | $\pm (2.7\% + 2.9\%)^{**}$      | $\pm (0.6\% + 0.4\%)$                                      |
| 2 mA secondary   | Gain [% of readings] + Offset | $\pm (2\% + \text{N/A})^{**}$ | $\pm (2.7\% + \text{N/A})^{**}$ | $\pm (0.6\% + 0.9\%)$                                      |
| 20 mA primary    | [% of range]                  | $\pm (2\% + 2\%)^{**}$        | $\pm (2.7\% + 2.9\%)^{**}$      | $\pm (0.6\% + 0.3\%)$                                      |
| 2 mA primary     |                               | $\pm (2\% + 2\%)^{**}$        | $\pm (2.7\% + 2.9\%)^{**}$      | $\pm (0.7\% + 0.3\%)$                                      |
| 200 μA secondary |                               | $\pm (2\% + 2\%)^{**}$        | $\pm (2.7\% + 2.9\%)^{**}$      | $\pm (0.6\% + 0.4\%)$                                      |
| 20 μA secondary  |                               | $\pm (2\% + \text{N/A})^{**}$ | $\pm (2.7\% + \text{N/A})^{**}$ | $\pm (0.7\% + 0.9\%)$                                      |

1. Accuracy is defined at VCM = 0 V (zero Common Mode input voltage at either  $+I_{IN}$  or  $-I_{IN}$ ). Add 0.9% typical to Offset error for Vcm up to 12 V. The “reading” is defined as measured value. DC measurement condition: 20 ms averaged.
2. After executing the User Calibration (both gain and offset) with mainframe.

Table 30. CX1102A other characteristics

|  |                              | Description                        |
|--|------------------------------|------------------------------------|
| Rise time (10 to 90%)                            |                              | 0.35/bandwidth                     |
| Input common mode impedance <sup>1</sup>         |                              | 750 M $\Omega$ // 18 pF (Nominal)  |
| Measurable over range                            |                              | 10% of range                       |
| Burden voltage                                   |                              | R <sub>IN</sub> * Measured current |
| Maximum input voltage (common mode) <sup>2</sup> | Peak voltage (DC + AC) limit | $\pm$ 12 V                         |
| Absolute maximum input current                   | Range                        | Protection <sup>4</sup>            |
|  | 1 A primary                  | 1.5 A <sup>3</sup>                 |
|  | 200 mA primary               |                                    |
|  | 20 mA secondary              |                                    |
|  | 2 mA secondary               |                                    |
|  | 20 mA primary                | 50 mA                              |
|  | 2 mA primary                 |                                    |
|  | 200 $\mu$ A secondary        |                                    |
| 20 $\mu$ A secondary                             |                              |                                    |

1. Measured with CX1201A.
2. All current measurement ranges.
3. CX1203A with 50  $\Omega$  setting: 125 mA.
4. See "CX1100 User's Guide" (CX1100-90000) for more information.

Table 31. CX1102A general information <sup>1</sup>

|                               | Description   |
|-------------------------------|---|
| Cable length                  | Sensor cable: 1.5 m, GND lead: 16 cm  |
| Dimension <sup>2</sup>        | 46.8 mm (W), 31.9 mm (H), 215.3 mm (D)                                      |
| Weight                        | 600 g   |
| Furnished accessories         | 1 each coaxial termination adapter sensor head (CX1203A)                    |
|                               | 1 each coaxial cable, SMA plug to open, 100 mm (8121-2773) <sup>3</sup>     |
|                               | 1 each coaxial cable, SMA plug to MHF plug, 100 mm (8121-2774) <sup>3</sup> |
|                               | 1 each MHF pullin tool (8710-2791) <sup>3</sup>                             |
|                               | 5 each coaxial cable, MHF plug, shorted, 21 mm (8121-2780) <sup>3</sup>     |
|                               | 5 each RF connector, MHF jack straight SMT (1250-3656) <sup>3</sup>         |
|                               | 1 each SMA(P) to BNC(J) 50 $\Omega$ coaxial adapter (1250-3975)             |
| 1 each GND lead (C1101-61711) |   |

1. Refer to mainframe's "Environmental and general" part for other information.
2. CX1203A Sensor Head is included. Cable and adapter are not included.
3. CX1203A's accessories.

# CX1103A Characteristics

Table 32. CX1103A characteristics overview

|                     | Range  | R <sub>IN</sub>    | Noise (rms) <sup>1</sup> | Maximum bandwidth (-3 dB) <sup>2</sup> | DC offset range and resolution |
|---------------------|--------|--------------------|--------------------------|--|--------------------------------|
| Current measurement | 20 mA  |                    | 5 μA                     | 200 MHz                                | ± 20 mA                        |
|                     | 2 mA   | 50 Ω typ, 55 Ω max | 1.5 μA                   | 75 MHz                                 | 0.8 μA resolution              |
|                     | 200 μA | (50 Ω input ON)    | 150 nA                   | 9 MHz                                  | ± 200 μA                       |
|                     | 20 μA  | 4 Ω typ, 6 Ω max   | 25 nA                    | 2.5 MHz                                | 8 nA resolution                |
|                     | 2 μA   | (50 Ω input OFF)   | 1.5 nA                   | 250 kHz                                | ± 2 μA                         |
|                     | 200 nA |                    | 150 pA                   | 100 kHz                                | 80 pA resolution               |

1. 20 MHz noise bandwidth measured with mainframe.
2. Standalone bandwidth. The effective measurement bandwidth when connected to mainframe can be estimated by the following equation.

$$BW_{\text{effective}} = \frac{1}{\sqrt{\left(\frac{1}{BW_{\text{sensor}}}\right)^2 + \left(\frac{1}{BW_{\text{mainframe}}}\right)^2}}$$

Table 33. CX1103A DC measurement accuracy<sup>1</sup>

| Range  |                        | Standalone<br>23 ± 5 °C | With mainframe<br>23 ± 5 °C | T <sub>USERCAL</sub> ± 3 °C, 24 hrs <sup>2</sup> |
|--------|------------------------|-------------------------|-----------------------------|--|
| 20 mA  |                        | ± (2% + 2%) **          | ± (2.7% + 2.9%) **          | ± (0.6% + 0.3%)                                  |
| 2 mA   |                        | ± (2% + 2%) **          | ± (2.7% + 2.9%) **          | ± (0.6% + 0.4%)                                  |
| 200 μA | Gain [% of readings] + | ± (2% + 2%) **          | ± (2.7% + 2.9%) **          | ± (0.6% + 0.4%)                                  |
| 20 μA  | Offset [% of readings] | ± (2% + 2%) **          | ± (2.7% + 2.9%) **          | ± (0.6% + 0.4%)                                  |
| 2 μA   |                        | ± (2% + 2%) **          | ± (2.7% + 2.9%) **          | ± (1.3% + 0.4%)                                  |
| 200 nA |                        | ± (2% + 2%) **          | ± (2.7% + 2.9%) **          | ± (1.3% + 0.3%)                                  |

1. Accuracy is defined at DC offset = 0 A. The "reading" is defined as measured value. DC measurement condition: 20 ms averaged.
2. After executing the User Calibration with mainframe. Supplemental characteristics.

Table 34. CX1103A other characteristics

|  | Description                        |
|--|------------------------------------|
| Rise time (10% to 90%)                           | 0.35 / Bandwidth                   |
| Measurable over range                            | 10% of range                       |
| Burden voltage                                   | R <sub>IN</sub> • Measured current |
| Maximum input voltage (common mode) <sup>1</sup> | Input 50 Ω OFF                     |
|  | Input 50 Ω ON                      |
| Absolute maximum input current <sup>2</sup>      | 125 mA                             |

1. All current measurement ranges.
2. See "CX1100 User's Guide" (CX1100-90000) for more information.

Table 35. CX1103A general information<sup>1</sup>

|                       | Description  |
|-----------------------|--|
| Cable length          | Sensor cable: 1.5 m, GND lead: 16 cm                     |
| Dimension             | 45.8 mm (W), 28.1 mm (H), 163.1 mm (D)                   |
| Weight                | 300 g  |
| Furnished accessories | 1 each SMA(P) to BNC(J) 50 Ω coaxial adapter (1250-3975) |
|                       | 1 each GND lead (C1101-61711)                            |

1. Refer to mainframe's "Environmental and general" part for other information.



# CX1104A Characteristics

Table 36. CX1104A characteristics overview

| Resistive sensor head | Range (upper/lower) | Typical $R_{IN}^1$ | Noise (rms) at 20 MHz NBW | Noise (rms) at 2.5 kHz NBW <sup>2</sup> | Maximum bandwidth (-3 dB) <sup>3</sup> |
|-----------------------|---------------------|--------------------|---------------------------|---|--|
| CX1211A               | 15.0 A              | 5.5 mΩ             | 48 mA                     | 1.6 mA                                  | 20 MHz                                 |
|                       | 10.0 A              |                    | 8.8 mA                    | 160 μA                                  |  |
| CX1212A               | 10.0 A              | 8.0 mΩ             | 24 mA                     | 800 μA                                  |  |
|                       | 5.0 A               |                    | 4.4 mA                    | 80 μA                                   |  |
| CX1213A               | 5.0 A               | 23 mΩ              | 6.0 mA                    | 200 μA                                  |  |
|                       | 1.25 A              |                    | 1.1 mA                    | 20 μA                                   |  |
| CX1214A               | 3.0 A               | 53 mΩ              | 2.4 mA                    | 80 μA                                   |  |
|                       | 500 mA              |                    | 440 μA                    | 8.0 μA                                  |  |
| CX1215A               | 2.0 A               | 103 mΩ             | 1.2 mA                    | 40 μA                                   |  |
|                       | 250 mA              |                    | 220 μA                    | 4.0 μA                                  |  |
| CX1216A               | 250 mA              | 1.0 Ω              | 120 μA                    | 4.0 μA                                  |  |
|                       | 25 mA               |                    | 22 μA                     | 400 nA                                  |  |

1.  $R_{IN}$  includes both current sensing resistance and parasitic resistance in the sensor head. The sensing resistance is calibrated.
2. High resolution mode is enabled.
3. Standalone bandwidth is measured at the sensor head connectors. The effective measurement bandwidth when connected to the mainframe can be estimated by the following equation.

$$BW_{\text{effective}} = \frac{1}{\sqrt{\frac{1}{BW_{\text{sensor}}^2} + \frac{1}{BW_{\text{mainframe}}^2}}}$$

Table 37. CX1104A DC current measurement accuracy<sup>1,3</sup>

| Resistive sensor head | Range  |  | Standalone           | With mainframe       |   |
|-----------------------|--------|--|----------------------|----------------------|---|
|                       |        |  | 23 ± 5 °C            | 23 ± 5 °C            | $T_{\text{USERCAL}} \pm 3 \text{ °C}, 24 \text{ hrs}^2$ |
| CX1211A               | 15 A   | Gain [% of reading] +<br>Offset [% of range] | ± (3.3 % + 1.0 %) ** | ± (4.0 % + 7.1 %) ** | ± (4.0 % + 2.0 %)                                       |
|                       | 10 A   |  | ± (3.5 % + 0.2 %) ** | ± (4.2 % + 1.1 %) ** | ± (4.2 % + 0.3 %)                                       |
| CX1212A               | 10 A   |  | ± (3.3 % + 0.8 %) ** | ± (4.0 % + 5.3 %) ** | ± (4.0 % + 1.5 %)                                       |
|                       | 5 A    |  | ± (3.5 % + 0.2 %) ** | ± (4.2 % + 1.1 %) ** | ± (4.2 % + 0.3 %)                                       |
| CX1213A               | 5 A    |  | ± (1.9 % + 0.4 %) ** | ± (2.6 % + 2.7 %) ** | ± (2.6 % + 0.8 %)                                       |
|                       | 1.25 A |  | ± (2.1 % + 0.2 %) ** | ± (2.8 % + 1.1 %) ** | ± (2.8 % + 0.3 %)                                       |
| CX1214A               | 3 A    |  | ± (1.0 % + 0.3 %) ** | ± (1.7 % + 1.8 %) ** | ± (1.7 % + 0.5 %)                                       |
|                       | 500 mA |  | ± (1.3 % + 0.2 %) ** | ± (2.0 % + 1.1 %) ** | ± (2.0 % + 0.3 %)                                       |
| CX1215A               | 2 A    |  | ± (1.6 % + 0.2 %) ** | ± (2.3 % + 1.3 %) ** | ± (2.3 % + 0.4 %)                                       |
|                       | 250 mA |  | ± (1.8 % + 0.2 %) ** | ± (2.5 % + 1.1 %) ** | ± (2.5 % + 0.3 %)                                       |
| CX1216A               | 250 mA |  | ± (1.5 % + 0.2 %) ** | ± (2.2 % + 1.1 %) ** | ± (2.2 % + 0.3 %)                                       |
|                       | 25 mA  |  | ± (1.7 % + 0.2 %) ** | ± (2.4 % + 1.1 %) ** | ± (2.4 % + 0.3 %)                                       |

1. Accuracy is defined at  $V_{CM} = 0 \text{ V}$  (zero Common Mode input voltage at either  $+I_N$  or  $-I_N$ ). The "reading" is defined as measured value. DC measurement condition: 20 ms averaged.
2. After executing User Calibration with the mainframe. High Resolution mode in enabled.
3. The accuracy is derived from the combined accuracy specifications for the sensor and the resistive sensor head tabulated in Table 15 and Table 25.

Table 38. CX1104A DC voltage measurement accuracy <sup>1, 2</sup>

| Range                |                        | Standalone<br>23 ± 5 °C | With mainframe<br>23 ± 5 °C | T <sub>USERCAL</sub> ± 3 °C, 24 hrs <sup>3</sup> |
|----------------------|------------------------|-------------------------|-----------------------------|--|
| 250 mV (Upper range) | Gain [% of readings] + | ± (0.58 % + 0.15 %) **  | ± (1.28 % + 1.05%) **       | ± (NA + 0.3 %)                                   |
| 25 mV (Lower range)  | Offset [% of range]    | ± (0.84 % + 0.15 %) **  | ± (1.54 % + 1.05 %) **      | ± (NA + 0.3 %)                                   |

1. Accuracy is defined at  $V_{CM} = 0$  V (zero Common Mode input voltage at either  $+I_N$  or  $-I_N$ ). The "reading" is defined as measured value. DC measurement condition: 20 ms averaged.
2. CX1104A alone is a voltage sensor and has a voltage measurement accuracy specification tabulated above.
3. After executing User Calibration with the mainframe. High Resolution mode enabled.

Table 39. CX1104A other characteristics

|  |                   | Description              |
|--|-------------------|--------------------------|
| Rise time (10% to 90%)                   |                   | 0.35/bandwidth           |
| Input common mode impedance <sup>1</sup> |                   | 20 MΩ // 32 pF (Nominal) |
| Overdrive recover time <sup>2</sup>      |                   | 100 ns                   |
| Maximum input voltage (common mode)      | DC peak           | ± 40 V                   |
|  | DC to 0.4 Hz      | Linear change            |
|  | 0.4 Hz to 100 MHz | ± 6 V                    |
| CMRR                                     | 1 kHz             | 110 dB                   |
|  | 1 MHz             | 50 dB                    |
|  | 10 MHz            | 40 dB                    |

1. See "CX1100 User's Guide" (CX1100-900000) for more information.
2. Time to settle to within 10% of Range full scale when driven by square pulse input having amplitude of  $V_{max\_ND}$  (± 280 mV for upper range, ± 75 mV for lower range).

Table 40. CX1104A general information <sup>1</sup>

|                        | Description  |
|------------------------|--|
| Cable length           | Sensor cable: 1.5 m, GND lead: 16 cm, USB cable: 15 cm |
| Dimension <sup>2</sup> | 30.0 mm (W), 20.5 mm (H), 205.2 mm (D)                 |
| Weight                 | 300 g  |
| Furnished accessories  | 1 each USB Type-C cable (C1104-61701)                  |
|                        | 1 each banana adapter (C1210-60001)                    |
|                        | 1 each ground lead (C1101-61711)                       |

1. Refer to the mainframe's "Environmental and general" part for other information.
2. Cable and adapter are not included.

# CX1105A Characteristics

Table 41. CX1105A characteristics overview

| Range  | Noise (rms) at 20 MHz NBW | Noise (rms) at 2.5 kHz NBW <sup>1</sup> | Maximum bandwidth (-3 dB) <sup>2</sup> |
|--------|---------------------------|---|--|
| 2.5 V  | 1100 $\mu$ V              | 200 $\mu$ V                             | 100 MHz                                |
| 1 V    | 1100 $\mu$ V              | 200 $\mu$ V                             |  |
| 250 mV | 45 $\mu$ V                | 3.0 $\mu$ V                             |  |
| 100 mV | 24 $\mu$ V                | 1.3 $\mu$ V                             |  |
| 25 mV  | 20 $\mu$ V                | 400 nV                                  |  |

1. High resolution mode is enabled.
2. The effective measurement bandwidth when connected to the mainframe can be estimated by the following equation.

$$BW_{\text{effective}} = \frac{1}{\sqrt{\frac{1}{BW_{\text{sensor}}^2} + \frac{1}{BW_{\text{mainframe}}^2}}}$$

Table 42. CX1105A DC measurement accuracy <sup>1</sup>

| Range <sup>2,3</sup> |                       | Standalone                 | With mainframe             | $T_{\text{USERCAL}} \pm 3^\circ\text{C}, 24 \text{ hrs}^3$ |
|----------------------|-----------------------|----------------------------|----------------------------|--|
|                      |                       | $23 \pm 5^\circ\text{C}$   | $23 \pm 5^\circ\text{C}$   |  |
| 2.5 V                |                       | $\pm (0.8\% + 1.0\%)^{**}$ | $\pm (1.5\% + 2.2\%)^{**}$ | $\pm (1.5\% + 0.6\%)$                                      |
| 1 V                  |                       | $\pm (0.8\% + 2.1\%)^{**}$ | $\pm (1.5\% + 3.3\%)^{**}$ | $\pm (1.5\% + 0.8\%)$                                      |
| 250 mV               | Gain [% of reading] + | $\pm (0.7\% + 0.2\%)^{**}$ | $\pm (1.4\% + 1.1\%)^{**}$ | $\pm (1.4\% + 0.3\%)$                                      |
| 100 mV               | Offset [% of range]   | $\pm (0.7\% + 0.2\%)^{**}$ | $\pm (1.4\% + 1.1\%)^{**}$ | $\pm (1.4\% + 0.3\%)$                                      |
| 25 mV                |                       | $\pm (0.7\% + 0.2\%)^{**}$ | $\pm (1.4\% + 1.1\%)^{**}$ | $\pm (1.4\% + 0.3\%)$                                      |

1. Accuracy is defined at  $V_{\text{CM}} = 0 \text{ V}$  (zero Common Mode input voltage at either  $+V_{\text{IN}}$  or  $-V_{\text{IN}}$ ). The "reading" is defined as measured value. DC measurement condition: 20 ms averaged.
2. 2.5 V and 1 V Range  $V_{\text{cm}}$ ; common mode input voltage at either input of  $+V_{\text{in}}$  or  $-V_{\text{in}}$ . Add 0.2 % to Offset error for  $V_{\text{cm}}$  up to 40 V.
3. After executing the User Calibration with the mainframe. High resolution mode is enabled.

Table 43. CX1105A input impedance

| Range  | Input impedance at $23 \pm 5^\circ\text{C}$ |                         |
|--------|---|-------------------------|
|        | Common                                      | Differential            |
| 2.5 V  | 2 M $\Omega$ //9.5 pF                       | 3.9 M $\Omega$ //4.8 pF |
| 1 V    |   |                         |
| 250 mV | 21 M $\Omega$ //24 pF (+IN)                 | 42 M $\Omega$ //16 pF   |
|        | 21 M $\Omega$ //27 pF (-IN)                 |                         |
| 100 mV | 21 M $\Omega$ //24 pF (+IN)                 |                         |
|        | 21 M $\Omega$ //27 pF (-IN)                 |                         |
| 25 mV  | 21 M $\Omega$ //24 pF (+IN)                 |                         |
|        | 21 M $\Omega$ //27 pF (-IN)                 |                         |

Table 44. CX1105A maximum input voltage

| Range  | Maximum input voltage<br>(Differential mode) | Maximum input voltage<br>(Common mode) |               |                 |
|--------|--|--|---------------|-----------------|
|        |  | DC peak                                | DC to 3 Hz    | 3 Hz to 100 MHz |
| 2.5 V  | ± 40 V                                       | ± 40 V                                 | Linear change | ± 5 V           |
| 1 V    |  |  |               |                 |
| 250 mV | +4 V/-1.8 V                                  | ± 6 V                                  | Linear change | ± 0.5 V         |
| 100 mV |  |  |               |                 |
| 25 mV  |  |  |               |                 |

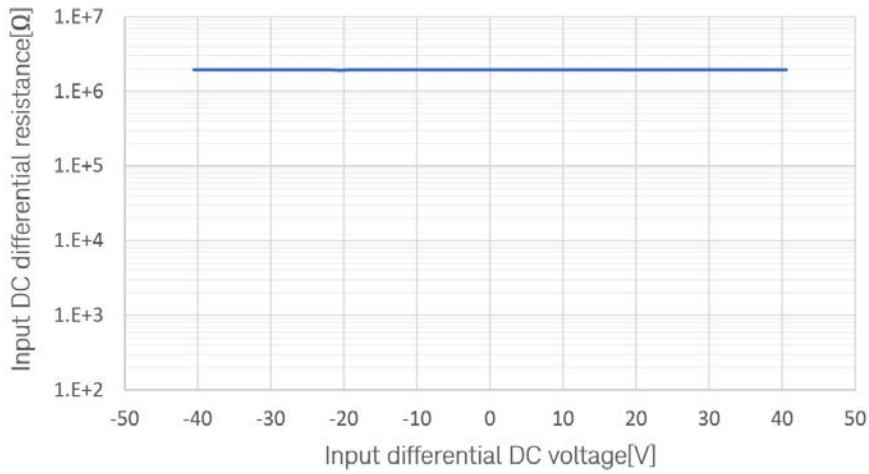


Figure 42. Input differential DC resistance 2.5 V/1 V range (either input terminal is grounded).

Supplemental characteristics

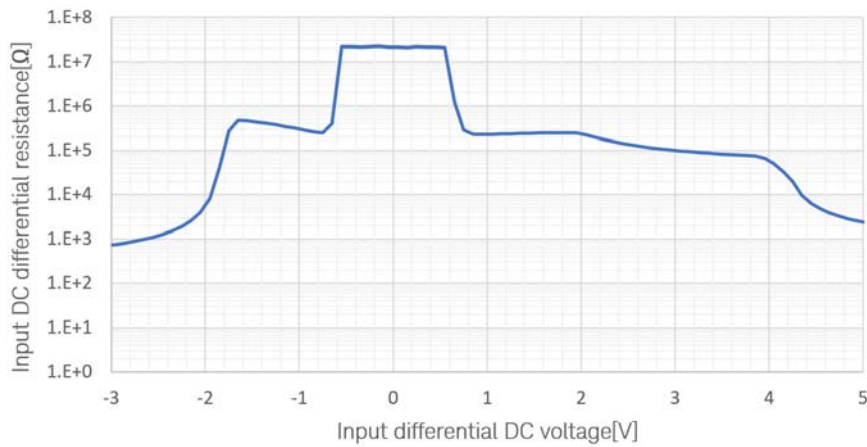


Figure 43. Input differential DC resistance 250 mV/100 mV/25 mV range (either input terminal is grounded).

Supplemental characteristics

Table 45. CX1105A other characteristics

|                                  | Description     |
|----------------------------------|-----------------|
| Rise and fall times (10 to 90 %) | 0.35/bandwidth  |
| CMRR at 1 MHz                    | 60 dB           |
| Input coupling                   | DC, AC (550 Hz) |

Table 46. CX1105A general information <sup>1</sup>

|                        | Description   |
|------------------------|---|
| Cable length           | Sensor cable: 1.5 m, GND lead: 16 cm                            |
| Dimension <sup>2</sup> | 30.0 mm (W), 20.5 mm (H), 203.4 mm (D)                          |
| Weight                 | 300 g   |
| Furnished accessories  | 1 each Test Lead (n = 5, 5959-9334)                             |
|                        | 1 each Twisted Pair Cable Soldering Model (100 mm, C1105-61702) |
|                        | 1 each Twisted Pair Cable Socket Model (100 mm, C1105-61701)    |
|                        | 1 each Test Adapter (C1105-66602)                               |
|                        | 1 each Adjustment Tool (8710-2831)                              |
|                        | 1 each Tool Grabber Clip (1400-3652)                            |
|                        | 1 each Grabber Mini (n = 2, 1400-1422)                          |
|                        | 1 Each Ground Lead (C1101-61711)                                |

1. Refer to the mainframe's "Environmental and general" part for other information.
2. Cable and adapter are not included.

## CX1211A/CX1212A/CX1213A/CX1214A/CX1215A/CX1216A Characteristics

Warranted specifications are denoted by\*\*, and all others are supplemental characteristics. Specifications are valid after a 30-minute warm-up and  $23 \pm 5$  °C.

### Measurement accuracy

Measurement accuracy can be affected by RF electro-magnetic field having the strengths greater than 3 V/m in the frequency range of 80 MHz to 2 GHz or 1 V/m in the frequency range of 2 GHz to 2.7 GHz. The extent of this effect depends upon how the instrument is positioned and shielded.

Table 47. CX121xA maximum current

| Resistive sensor head | Maximum DC/RMS current | Peak current |
|-----------------------|------------------------|--------------|
| CX1211A               | 15 A **                | 15 A **      |
| CX1212A               | 10 A **                | 15 A **      |
| CX1213A               | 5 A **                 | 10 A **      |
| CX1214A               | 3 A **                 | 5 A **       |
| CX1215A               | 2 A **                 | 2.5 A **     |
| CX1216A               | 0.25 A **              | 0.25 A **    |

Table 48. CX121xA sense resistor accuracy <sup>1</sup>

| Resistive sensor head | Typical $R_{IN}$ | Nominal sense resistor value | Standalone accuracy at $23 \pm 5$ °C |                   |                     |
|-----------------------|------------------|------------------------------|--------------------------------------|-------------------|---------------------|
|                       |                  |                              | Accuracy within $I_{SPEC}$           | $I_{SPEC}$        | Full-scale accuracy |
| CX1211A               | 5.5 m $\Omega$   | 2.5 m $\Omega$               | $\pm 2.7$ % **                       | 10 A <sup>2</sup> | $\pm 3.3$ %         |
| CX1212A               | 8 m $\Omega$     | 5 m $\Omega$                 | $\pm 2.7$ % **                       | 10 A <sup>2</sup> | $\pm 2.9$ %         |
| CX1213A               | 23 m $\Omega$    | 20 m $\Omega$                | $\pm 1.3$ % **                       | 1.5 A             | $\pm 1.4$ %         |
| CX1214A               | 53 m $\Omega$    | 50 m $\Omega$                | $\pm 0.5$ % **                       | 1.5 A             | $\pm 0.5$ %         |
| CX1215A               | 103 m $\Omega$   | 100 m $\Omega$               | $\pm 1.0$ % **                       | 1.0 A             | $\pm 1.0$ %         |
| CX1216A               | 1 $\Omega$       | 1 $\Omega$                   | $\pm 0.9$ % **                       | 0.25 A            | $\pm 0.9$ %         |

1. Accuracy is defined at  $V_{CM} = 0$  V (zero Common Mode input voltage at either  $+I_{IN}$  or  $-I_{IN}$ ). The “reading” is defined as measured value. DC measurement condition: 20 ms averaged.
2. Specified by pulsed measurement: pulse width = 1 ms, duty = 0.1 %.

Table 49. CX121xA general information <sup>1</sup>

|                       | Description   |
|-----------------------|---|
| Dimension             | 30.0 mm (W), 14.0 mm/21.5 mm (H), 48.7 mm (D)       |
| Weight                | 20 g  |
| Furnished accessories | 1 each Wire Set (red and black, n = 5, C1104-68001) |

1. Refer to the mainframe’s “Environmental and general” part (publication number: 5992-1430EN) for other information.

# CX1151A Passive Probe Interface Adapter Characteristics

Warranted specifications are denoted by\*\*, and all others are supplemental characteristics. Specifications are valid after a 30-minute warm-up and 23 ± 5 °C. All these characteristics are defined by 14-bit acquisition resolution unless otherwise stated.

## Measurement accuracy

Measurement accuracy can be affected by RF electro-magnetic field having the strengths greater than 3 V/m in the frequency range of 80 MHz to 2 GHz or 1 V/m in the frequency range of 2 GHz to 2.7 GHz. The extent of this effect depends upon how the instrument is positioned and shielded.

Table 70. CX1151A characteristics overview

|                     | Range  | Noise (rms) <sup>1</sup> | Maximum bandwidth (-3 dB) <sup>2</sup> | DC offset range and resolution |
|---------------------|--------|--------------------------|--|--------------------------------|
| Voltage measurement | 8 V    | 5.0 mV                   | 300 MHz                                | ± 16 V, 16-bit resolution      |
|                     | 4 V    | 2.8 mV                   |  |                                |
|                     | 1.6 V  | 1.8 mV                   |  |                                |
|                     | 0.4 V  | 250 µV                   |  | ± 0.8 V, 16-bit resolution     |
|                     | 0.2 V  | 140 µV                   |  |                                |
|                     | 0.08 V | 90 µV                    |  |                                |

1. Full bandwidth measured with mainframe (Option B20; 200 MHz bandwidth).
2. Standalone bandwidth with an N2843A passive probe. The effective measurement bandwidth when connected to the mainframe can be estimated by the following equation.

$$BW_{\text{effective}} = \frac{1}{\sqrt{\left(\frac{1}{BW_{\text{adaptor}}}\right)^2 + \left(\frac{1}{BW_{\text{probe}}}\right)^2 + \left(\frac{1}{BW_{\text{mainframe}}}\right)^2}}$$

Table 71. CX1151A DC measurement accuracy<sup>1</sup>

| Range  |                        | Standalone 23 ± 5 °C |                    | With mainframe   |   |
|--------|------------------------|----------------------|--------------------|--|---|
|        |                        |                      | 23 ± 5 °C          | T <sub>USERCAL</sub> ± 3 °C, 24 hrs (High speed mode) <sup>2</sup> | T <sub>USERCAL</sub> ± 3 °C, 24 hrs (High resolution mode) <sup>3</sup> |
| 8 V    |                        | ± (0.6% + 0.8%) **   | ± (1.3% + 1.7%) ** | ± (0.4% + 0.6%)  | ± (0.3% + 0.4%)   |
| 4 V    |                        | ± (0.6% + 0.8%) **   | ± (1.3% + 1.7%) ** | ± (0.8% + 0.6%)  | ± (0.5% + 0.4%)   |
| 1.6 V  | Gain [% of readings] + | ± (0.6% + 0.8%) **   | ± (1.3% + 1.7%) ** | ± (0.8% + 0.6%)  | ± (0.5% + 0.4%)   |
| 0.4 V  | Offset [% of range]    | ± (0.6% + 0.8%) **   | ± (1.3% + 1.7%) ** | ± (0.4% + 0.6%)  | ± (0.3% + 0.4%)   |
| 0.2 V  |                        | ± (0.6% + 0.8%) **   | ± (1.3% + 1.7%) ** | ± (0.8% + 0.6%)  | ± (0.5% + 0.4%)   |
| 0.08 V |                        | ± (0.9% + 1.2%) **   | ± (1.6% + 2.1%) ** | ± (0.8% + 0.6%)  | ± (0.5% + 0.4%)   |

Table 72. Range with 10:1 passive probe<sup>4</sup>

|       |                               | T <sub>USERCAL</sub> ± 3 °C, 24 hrs (High speed mode) <sup>2</sup> | T <sub>USERCAL</sub> ± 3 °C, 24 hrs (High resolution mode) <sup>3</sup> |
|-------|-------------------------------|--|---|
| 80 V  |                               | ± (2.1% + 0.6%)  | ± (1.1% + 0.4%)   |
| 40 V  |                               | ± (1.5% + 0.6%)  | ± (0.8% + 0.4%)   |
| 16 V  | Gain [% of readings] + Offset | ± (0.7% + 0.6%)  | ± (0.4% + 0.4%)   |
| 4 V   | [% of range]                  | ± (1.7% + 0.6%)  | ± (0.9% + 0.4%)   |
| 2 V   |                               | ± (1.2% + 0.6%)  | ± (0.7% + 0.4%)   |
| 0.8 V |                               | ± (0.4% + 0.6%)  | ± (0.3% + 0.4%)   |

1. DC measurement condition: 20 ms averaged.
2. After executing the User Calibration with mainframe. High speed mode (14-bit).
3. After executing the User Calibration with mainframe. High resolution mode (16-bit).
4. Passive probe used: N2843A.

Table 73. CX1151A other characteristics

|                                | Description                    |
|--------------------------------|--------------------------------|
| Rise and fall times (10to 90%) | 0.35/bandwidth                 |
| Input impedance                | 1 M $\Omega$ $\pm$ 0.1%, 13 pF |
| Input coupling                 | DC, AC (3.5 Hz)                |
| Maximum input voltage          | $\pm$ 100 V peak (DC + AC)     |

Table 74. CX1151A general information

|   | Description  |
|---|--|
| Dimension                                       | 58.6 mm (W), 30.2 mm (H), 87.5 mm (D)  |
| Weight  | 130 g  |
| Recommended passive probe products <sup>1</sup> | N2843A   |
| Supported passive probe products <sup>2</sup>   | (1:1) 10070D, N2870A<br>(10:1) 10073D, 10074D, N2862B, N2863B, N2871A, N2872A, N2873A, N2890A, N2894A, N2853A, N2843A, N2842A, N2841A, N2840A<br>(20:1) N2875A, (100:1) 10076C |

1. N2843A is used to measure characteristics shown above.

2. Supported probe's ratio can be detected by mainframe.

## CX1152A Digital Channel Characteristics (Mainframe: CX3324A Only)

Warranted specifications are denoted by\*\*, and all others are supplemental characteristics. Specifications are valid after a 30-minute warm-up and 23  $\pm$  5  $^{\circ}$ C.

Table 75. CX1152A vertical system - digital channels

|                              | Description  |
|------------------------------|--|
| Input channels               | 8 channels   |
| User-defined threshold range | $\pm$ 25 V, 10 mV step                                     |
| Maximum input voltage        | $\pm$ 40 V peak  |
| Threshold accuracy           | $\pm$ (150 mV + 3% of threshold setting)                   |
| Input dynamic range          | $\pm$ 25 V   |
| Minimum input voltage swing  | 500 mV peak-to-peak  |
| Input impedance              | 10 M $\Omega$ $\pm$ 2% with approximately 8 pF in parallel |
| Channel-to-channel skew      | 4 ns   |
| Resolution                   | 1 bit  |

1. 50  $\Omega$  input impedance.

2. CX1152A is required to enable the input digital channels.

Table 76. CX1152A general information

|                        | Description   |
|------------------------|---|
| Cable length           | Digital channel cable: 1.15 m, probe lead: 28.5 cm  |
| Dimension <sup>1</sup> | 68.1 mm (W), 18.5 mm (H), 103.0 mm (D)  |
| Weight                 | 130 g   |
| Furnished accessories  | 5 probe ground leads (5959-9334)<br>10 grabbers (5090-4832)<br>1 each BNC-probe tip adapter (C1152-60001) |

1. Dimension of pod. Leads and cables are not included.



## CX3300 Series Dimensional Drawing (Mainframe)

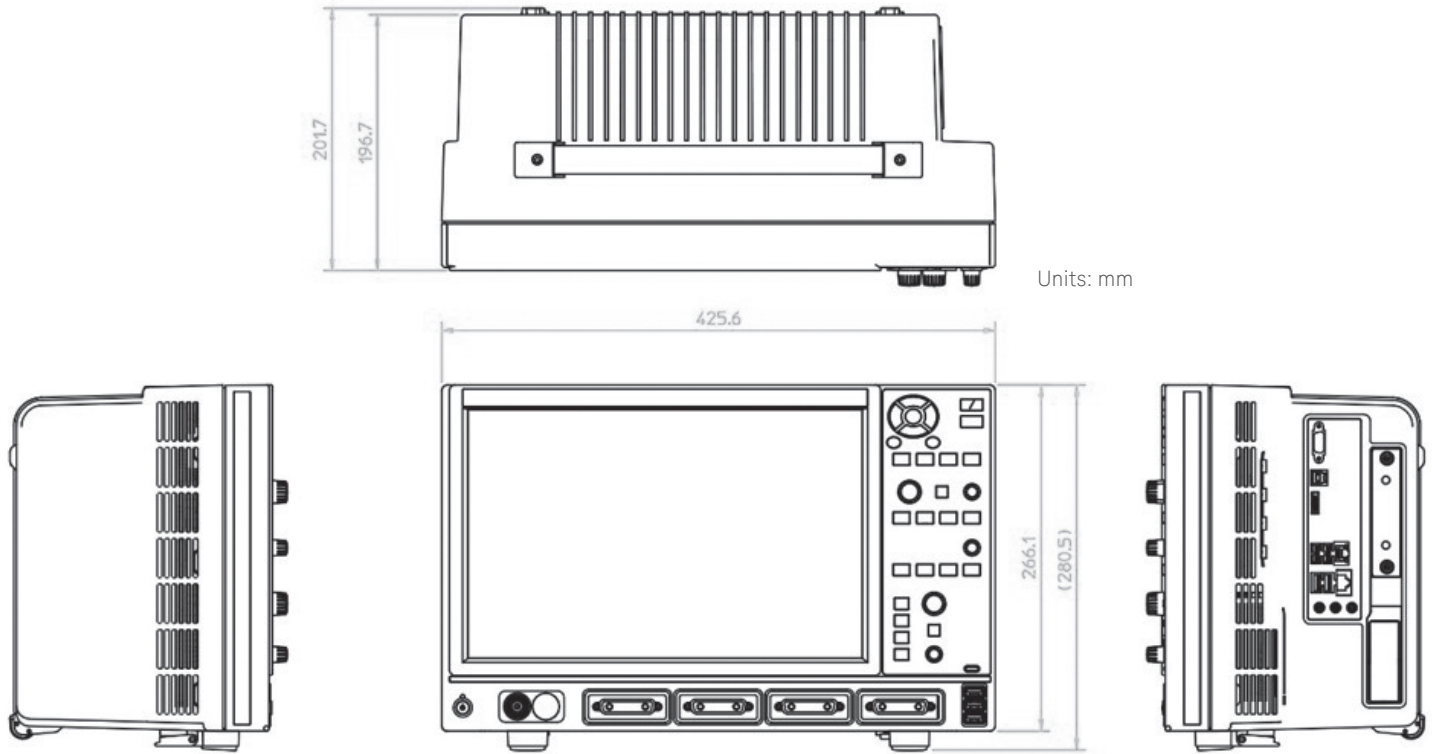


Figure 44. CX3300 Series schematic diagram.

Learn more at: [www.keysight.com](http://www.keysight.com)

For more information on Keysight Technologies' products, applications or services, please contact your local Keysight office. The complete list is available at: [www.keysight.com/find/contactus](http://www.keysight.com/find/contactus)

