

Keysight Technologies

M9391A PXIe Vector Signal Analyzer

1 MHz to 3 GHz or 6 GHz

Data Sheet

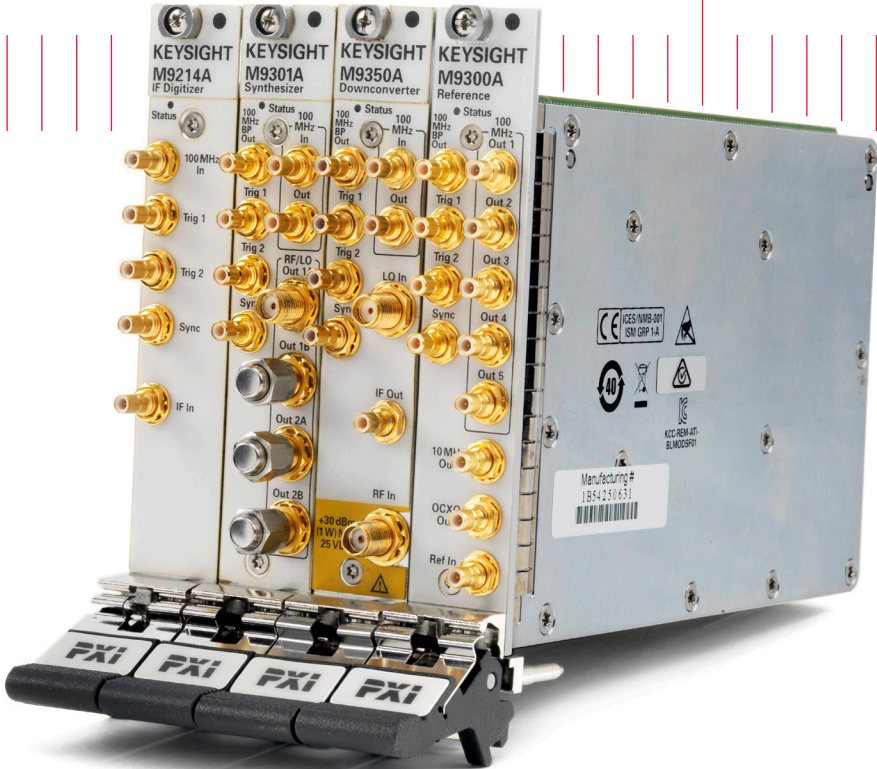

Unlocking Measurement Insights

Table of Contents

| | |
|--|----|
| Product Overview | 3 |
| Technical Specifications and Characteristics | 4 |
| Definitions for specifications | 4 |
| Recommended best practices in use | 4 |
| Block diagram | 5 |
| Frequency | 6 |
| Amplitude | 8 |
| Dynamic range | 11 |
| Spectral purity | 14 |
| Data acquisition | 16 |
| Measurement speed | 17 |
| Format-specific measurement data | 17 |
| Environmental and physical specifications | 21 |
| System requirements | 22 |
| Software | 23 |
| Setup and Calibration Services | 24 |
| Support and Warranty | 25 |
| Configuration and Ordering Information | 26 |

Overview

Be ready for tomorrow - today

RF requirements keep growing while timelines keep shrinking. To help ease the technical and business pressures, the right test solution provides continuity in measurements and longevity in capability. The Keysight Technologies, Inc. M9391A PXIe vector signal analyzer (PXI VSA) is the next logical step in RF signal analysis.

The M9391A PXI VSA, combined with the M9381A PXIe vector signal generator provides a complete solution for fast, high quality measurements optimized for RF manufacturing test environments.

To help you get proven results even faster, Keysight's PXI VSA can be used with X-Series measurement applications for modular instruments, 89600 VSA software and SystemVue. These software applications enable you to investigate, validate and test your RF communications designs.

From fully modular hardware to software leverage to worldwide support, the PXI VSA is the low-risk way to manage change and be ready for tomorrow—today.

Product description

The M9391A PXI VSA is a modular vector signal analyzer for frequencies from 1 MHz to 6 GHz and up to 160 MHz analysis bandwidth. The M9391A is comprised of four individual PXI modules - M9350A downconverter, M9214A digitizer, M9301A synthesizer and M9300A frequency reference. A single M9300A frequency reference can be shared between multiple instruments to minimize footprint.

The flexible, modular design of the M9391A enables you to efficiently scale to multi-channel signal analysis to test multiple-input, multiple-output (MIMO) devices. Capability can also be scaled with options for memory, frequency range and modulation bandwidth which can be easily upgraded in the field.

Applications

- Power amplifier and front-end-module design validation and manufacturing
- Radio transceiver design validation and production test
- MIMO and multi-channel device test

Reference solutions

Application specific reference solutions, a combination of recommended hardware, software, and measurement expertise, provide the essential components of a test system. The following reference solutions include the M9391A PXI VSA as a hardware component.

- RF PA/FEM characterization and test, Reference Solution for the industry's fastest envelope tracking test, rapid waveform download, tight synchronization, automated calibration and digital pre-distortion. For more information, see www.keysight.com/find/solution-padv
- LTE/LTE-A multi-channel test, Reference Solution for faster insight into carrier aggregation and spatial multiplexing designs. For more information, see www.keysight.com/find/solution-LTE



Figure 1. M9391A PXIe vector signal analyzer with four modules consisting of the M9214A digitizer, M9301A synthesizer, M9350A downconverter and M9300A frequency reference.

Technical Specifications and Characteristics

Definitions for specifications

Temperatures referred to in this document are defined as follows:

- Full temperature range = Individual module temperature of 25 to 75 °C, as reported by the module, and environment temperature of 0 to 55 °C.
- Controlled temperature range = Individual module temperature of 40 to 51 °C, as reported by the module, and environment temperature of 20 to 30 °C.

Specifications describe the warranted performance of calibrated instruments. Data represented in this document are specifications under the following conditions unless otherwise noted.

- Calibrated instruments have been stored for a minimum of 2 hours within the full temperature range
- 45 minute warm-up time
- Calibration cycle maintained
- When used with Keysight M9300A frequency reference and Keysight interconnect cables

Characteristics describe product performance that is useful in the application of the product, but that is not covered by the product warranty. Characteristics are often referred to as Typical or Nominal values and are italicized.

- **Typical** describes characteristic performance, which 80% of instruments will meet when operated within the controlled temperature range.
- **Nominal** describes representative performance that is useful in the application of the product when operated within the controlled temperature range.

Recommended best practices in use

- Use slot blockers and EMC filler panels in empty module slots to ensure proper operating temperatures. Keysight chassis and slot blockers optimize module temperature performance and reliability of test.
- Set chassis fan to high at environmental temperatures above 45 °C
- Maintain temperature stability for best multi-channel phase coherence
 - Set chassis fans to maximum
 - Maintain stable ambient temperature
 - Perform warm-up with session open and representative acquisition waveform running

Conversion type operating range

| Conversion types | Frequency range |
|------------------|-----------------------|
| Auto | 1 MHz to 3 or 6 GHz |
| Image protect | 1 MHz to 3 or 6 GHz |
| Single high | 400 MHz to 3 or 6 GHz |
| Single low | 1.1 GHz to 3 or 6 GHz |

Additional information

- Mixer level offset modifies the receiver gain prior to the first mixer of the receiver. A negative setting improves distortion (i.e., TOI) at the cost of noise performance (i.e., DANL). A positive setting improves noise performance at the cost of distortion.
- Performance described in this document applies for module temperature within ± 3 degrees of comprehensive alignment, unless otherwise noted.
- When used with a Keysight M9018A PXIe chassis, comprehensive alignment requires chassis FPGA version 1.05 or greater.
- When configured for multi-channel, phase-coherent operation (shared synthesizer configuration), instrument level warranted specifications only apply to the M9391A which was previously calibrated with the M9301A synthesizer, showing a valid calibration indicator. For all other M9391A channels, specifications revert to typical performance. If using an external LO distribution unit, such as the V2802A LO distribution network, specifications for all M9391A channels revert to typical performance.
- All graphs contain measured data from one unit and is representative of product performance within the controlled temperature range unless otherwise noted.
- The specifications contained in this document are subject to change.

Technical Specifications and Characteristics

Block diagram

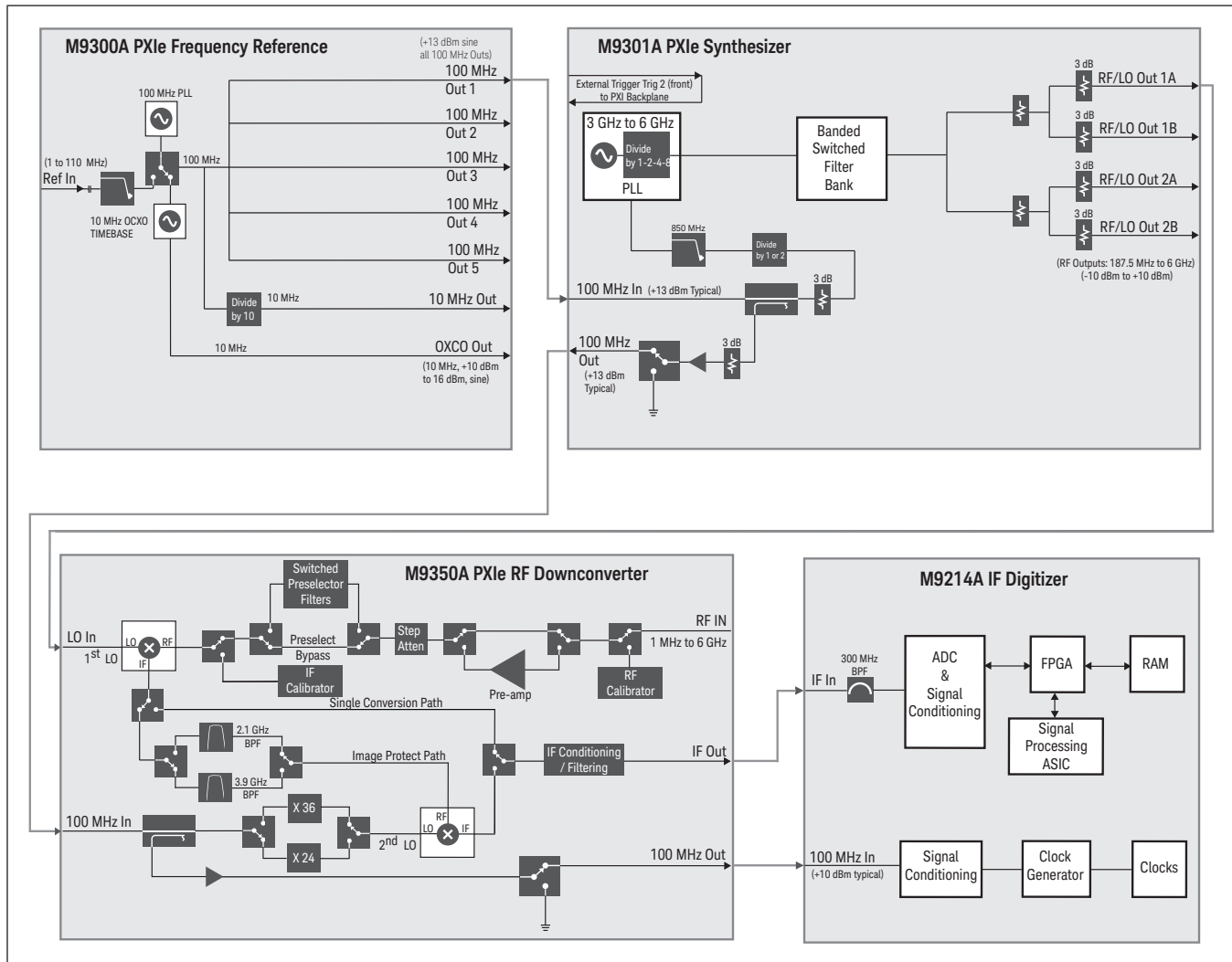

Figure 3. M9391A PXIe vector signal analyzer block diagram with four modules consisting of the M9301A synthesizer, M9350A downconverter, M9214A digitizer and optional M9300A frequency reference.

Technical Specifications and Characteristics

Frequency

Frequency range and resolution

| | |
|---------------------|----------------|
| Option F03 | 1 MHz to 3 GHz |
| Option F06 | 1 MHz to 6 GHz |
| Tuning resolution | 0.001 Hz |
| IF frequency | Nominal |
| 15 MHz filter | 326 MHz |
| 40 MHz filter | 240 MHz |
| 160 MHz filter | 300 MHz |

Analysis bandwidth ¹

| | | |
|-------------------|------------|---------|
| Maximum bandwidth | Option B04 | 40 MHz |
| | Option B10 | 100 MHz |
| | Option B16 | 160 MHz |

Frequency switching speed ^{2,3}

| | Sample rate | Acquisition bandwidth | Standard, nominal | Option UNZ, nominal |
|---|------------------------|-----------------------|--------------------------|----------------------------|
| List mode switching speed ⁴ | | | | |
| Baseband frequency offset change ⁵ | ≤ 100 MHz | ≤ 80 MHz | 5 ms | 27 μs |
| | > 100 MHz to < 180 MHz | > 80 MHz to < 144 MHz | 5 ms | 102 μs |
| | ≥ 180 MHz | ≥ 144 MHz | 5 ms | 15 μs |
| Arbitrary frequency change | | | 5 ms | 320 μs |
| Non-list mode switching speed ⁶ | | | Standard, nominal | Option UNZ, nominal |
| Baseband frequency offset change ⁵ | | | 5 ms | 310 μs |
| Arbitrary frequency change | | | 5 ms | 2.3 ms |

1. Instantaneous bandwidth (1 dB bandwidth) available around a center frequency over which the input signal can be digitized for further analysis or processing in the time, frequency or modulation domain.
2. When used with the M9018A PXIe chassis (2-link configuration: 1 x 8 [factory default]) and M9036A PXIe embedded controller.
3. Settled to within 1 kHz or 1 ppm, whichever is greater of final value. Does not include data acquisition or processing time. Amplitude settled to within 0.1 dB. Channel filter set to none. Applies for all conversion types.
4. Time from trigger input to frequency and amplitude settled. Minimum IQ sample rate ≥ 6 MHz. Minimum spectrum acquisition ≥ 4.8 MHz. Minimum power acquisition channel filter bandwidth ≥ 4.8 MHz. For lists with first point < 400 MHz or for frequency changes from > 400 MHz to < 400 MHz, add 40 ms.
5. Baseband offset can be adjusted ± from carrier frequency within limits determined by RF analysis bandwidth and IF filter bandwidth. Synthesizer frequency and amplitude are not changing. Baseband offset settled to within 1 kHz.
6. Mean time from IVI command to carrier frequency settled to within 1 kHz or 1 ppm, whichever is greater. Amplitude settled within 0.1 dB. Simultaneous carrier frequency and amplitude switching. For frequency changes from > 400 MHz to < 400 MHz, add 40 ms.

Technical Specifications and Characteristics

Frequency (continued)

Frequency reference (M9300A PXIe frequency reference module)

Reference outputs

100 MHz Out (Out 1 through Out 5)

Amplitude ≥ 10 dBm 13 dBm, *typical*

Connectors 5 SMB snap-on

Impedance 50 Ω , *nominal*

10 MHz Out

Amplitude 9.5 dBm, *nominal*

Connectors 1 SMB snap-on

Impedance 50 Ω , *nominal*

OCXO Out

Amplitude 11.5 dBm, *nominal*

Connectors 1 SMB snap-on

Impedance 50 Ω , *nominal*

Frequency accuracy

Same as accuracy of internal time base or external reference input

Internal timebase

Accuracy \pm [(time since last adjustment x aging rate) \pm temperature effects
 \pm calibration accuracy]

Frequency stability

Aging rate

Daily $< \pm 0.5$ ppb/day, after 72 hours of warm-up

Yearly $< \pm 0.1$ ppm/year, after 72 hours of warm-up

Total 10 years $< \pm 0.6$ ppm/10yrs, after 72 hours of warm-up

Achievable initial calibration accuracy
(at time of shipment) $\pm 5 \times 10^{-8}$

Temperature effects

20 to 30 °C $< \pm 10$ ppb

Full temperature range $< \pm 50$ ppb

Warm up

5 minutes over +20 to +30 °C, with respect to 1 hour $< \pm 0.1$ ppm

15 minutes over +20 to +30 °C, with respect to 1 hour $< \pm 0.01$ ppm

External reference input

Frequency 1 to 110 MHz, sine wave

Lock range ± 1 ppm, *nominal*

Amplitude 0 to 10 dBm, *nominal*

Connector 1 SMB snap-on

Impedance 50 Ω , *nominal*

Technical Specifications and Characteristics

Amplitude

Input level

| | | |
|--------------------------------------|------------------|---------|
| Max safe average total power | +30 dBm (1 W) | |
| Max DC voltage | 25 Vdc | |
| Max RF input (specified performance) | 1 to 2 MHz | 0 dBm |
| | 2 to 4 MHz | +4 dBm |
| | 4 to 100 MHz | +12 dBm |
| | 100 MHz to 6 GHz | +30 dBm |

Expected input level setting

| | |
|---------------------------|-----------------|
| Range | |
| Pre-amp ON | -170 to 0 dBm |
| Pre-amp OFF | -170 to +30 dBm |
| Pre-amp AUTO ⁷ | -170 to +30 dBm |
| Resolution | 0.1 dB |

Absolute amplitude accuracy & total absolute amplitude accuracy

| Conversion type | Frequency | Full temperature range | | Controlled temperature range | | @ 46 °C module temp ¹⁰ , typical |
|---|-----------|--|--|--|--|--|
| | | Total absolute amplitude accuracy ⁸ | Absolute amplitude accuracy ⁹ | Total absolute amplitude accuracy ⁸ | Absolute amplitude accuracy ⁹ | Total absolute amplitude accuracy ⁸ |
| 40 MHz IF filter | | | | | | |
| Module temperature within ± 3 °C of alignment, pre-amp ON & OFF | | | | | | |
| Image protect | ≤ 3 GHz | ±1.78 dB | ±1.72 dB | ±1.27 dB | ±1.21 dB | ±0.46 dB |
| | > 3 GHz | ±1.54 dB | ±1.48 dB | ±1.19 dB | ±1.13 dB | ±0.46 dB |
| Single | All | ±1.47 dB | ±1.41 dB | ±1.22 dB | ±1.17 dB | ±0.45 dB |
| 160 MHz IF filter | | | | | | |
| Module temperature within ±3 °C of alignment, Pre-amp OFF¹¹ | | | | | | |
| Image protect | ≤ 3 GHz | ±1.46 dB | ±1.34 dB | ±0.96 dB | ±0.85 dB | ±0.33 dB |
| | > 3 GHz | ±1.54 dB | ±1.48 dB | ±1.16 dB | ±1.09 dB | ±0.45 dB |
| Single | All | ±1.18 dB | ±1.08 dB | ±0.94 dB | ±0.86 dB | ±0.36 dB |
| 160 MHz IF filter | | | | | | |
| Module temperature within ±3 °C of alignment, Pre-amp ON¹² | | | | | | |
| Image protect | ≤ 3 GHz | ±1.68 dB | ±1.60 dB | ±1.18 dB | ±1.10 dB | ±0.39 dB |
| | > 3 GHz | ±1.55 dB | ±1.49 dB | ±1.21 dB | ±1.15 dB | ±0.45 dB |
| Single | ≤ 3 GHz | ±1.09 dB | ±0.96 dB | ±0.85 dB | ±0.72 dB | ±0.29 dB |
| | > 3 GHz | ±1.36 dB | ±1.28 dB | ±1.04 dB | ±0.96 dB | ±0.39 dB |

7. At expected input level ≤ -37 dBm, pre-amp is switched on.

8. Total absolute amplitude accuracy is the total of all amplitude measurement errors. This specification includes the sum of the following individual specifications: linearity, expected input level switching uncertainty, IF bandwidth filter switching uncertainty, absolute amplitude accuracy. The wide range of settings used (i.e., expected input level, etc.) are tested independently. The individual error contributions are calculated as follows: a 99.8 % proportion and 95% confidence are computed for each parameter on a statistically significant number of instruments. The root-sum-square (RSS) of these four independent Gaussian parameters is then taken. To that RSS value, two environmental effects and measurement uncertainty are added. One environmental effect is that of temperature (full and controlled temperature range, as defined above) and the other is the temperature variation of ±3 degrees around a field alignment. Applies over the following subset of settings and conditions: expected input level -50 dBm to +30 dBm; input signals within 60 dB below expected input level; 40 MHz and 160 MHz IF filters; input signal at center frequency over full frequency range.

9. The absolute amplitude accuracy is the amplitude measurement error when only changing frequency. The expected input level, conversion type and IF bandwidth settings remain the same and the error introduced by those parameters are not included. Pre-amp auto/OFF expected input level +10 dBm and -12 dBm. Pre-amp ON expected input level -30 dBm.

10. Typical specifications shown at M9350A downconverter reported module temperature of 46 °C and a corresponding environment temperature of 25 °C.

11. When using pre-amp auto mode, applies for signal level within expected input level > -37 dBm.

12. When using pre-amp auto mode, applies for signal level within expected input level ≤ -37 dBm.

Technical Specifications and Characteristics

Amplitude (continued)

Amplitude repeatability and linearity

| | Input signal relative to expected input level setting | Specification |
|-------------------------|---|---|
| Repeatability | | <0.05 dB, nominal |
| Linearity ¹³ | >-35 dB | ± 0.12 dB ± 0.03 dB, nominal |
| | ≤ -35 dB | ± 0.21 dB ± 0.04 dB, nominal |

IF flatness^{14,15}

| Analysis bandwidth | IF filter | Nominal |
|--------------------|-----------|---------------|
| 40 MHz | 40 MHz | ± 0.08 dB |
| 100 MHz | 160 MHz | ± 0.09 dB |
| 160 MHz | 160 MHz | ± 0.10 dB |

IF phase linearity¹⁵

| Analysis bandwidth | Conversion type | Peak to peak, nominal |
|--------------------|-----------------|-----------------------|
| 40 MHz | All | 1.0° |
| 100 MHz | Single | 0.8° |
| | Image protect | 1.7° |
| 160 MHz | Single | 1.4° |
| | Image protect | 1.8° |

13. Input level 20 dB above the noise floor and dither on, no change in hardware settings, below expected input level.

14. Amplitude deviation from the mean error of the entire bandwidth, all conversion types.

15. Expected input level 0 dBm. Center frequency ≥ 250 MHz.

Technical Specifications and Characteristics

Amplitude (continued)

| IF bandwidth filter switching uncertainty ¹⁶ | Specification | Typical | Nominal |
|--|----------------------|----------------|----------------|
| | ±0.4 dB | ±0.15 dB | ±0.09 dB |

| Expected input level switching uncertainty | Specification | Typical | Nominal |
|---|----------------------|----------------|----------------|
| Pre-amp Auto/OFF | | | |
| Max input to +5 dBm | ±0.45 dB | ±0.14 dB | ±0.10 dB |
| Crossing +5 dBm | ±0.63 dB | ±0.24 dB | ±0.17 dB |
| Pre-amp OFF | | | |
| +5 to -50 dBm | ±0.41 dB | ±0.16 dB | ±0.11 dB |
| Pre-amp ON | | | |
| +0 to -50 dBm | ±0.64 dB | ±0.27 dB | ±0.21 dB |
| Pre-amp AUTO | | | |
| Crossing -37 dBm | ±0.95 dB | ±0.19 dB | ±0.12 dB |

| Amplitude switching speed | | |
|---|--------------------------|----------------------------|
| Arbitrary amplitude change | Standard, nominal | Option UNZ, nominal |
| List mode switching speed ¹⁷ | ≤ 5 ms | ≤ 136 μs |
| Non-list mode switching speed ¹⁸ | ≤ 5 ms | ≤ 1.5 ms |

| Input voltage standing wave ratio (VSWR) | Nominal |
|---|----------------|
| < 10 MHz | 1.7:1 |
| 10 MHz to 2.5 GHz | 1.4:1 |
| > 2.5 GHz | 1.7:1 |

16. Amplitude error relative to the reference IF bandwidth filter of 40 MHz.

17. Settled to within 0.1 dB of final value. Does not include data acquisition or processing time.
When used with the M9018A PXIe chassis (2-link configuration: 1 x 8 [factory default]) and the M9036A PXIe embedded controller.

18. Mean time from IVI command to amplitude settled.

Technical Specifications and Characteristics

Dynamic range

Displayed average noise level (DANL) ¹⁹

| Conversion type | Frequency | Specification | Nominal |
|-----------------|-----------------------|---------------|-------------|
| Pre-amp OFF | | | |
| Image protect | < 100 MHz | | -145 dBm/Hz |
| | 100 to < 700 MHz | -137 dBm/Hz | -147 dBm/Hz |
| | 700 MHz to < 5.75 GHz | -140 dBm/Hz | -148 dBm/Hz |
| | 5.75 to 6 GHz | -129 dBm/Hz | -146 dBm/Hz |
| Single | | | |
| Image protect | <1.2 GHz | -148 dBm/Hz | -154 dBm/Hz |
| | 1.2 to 3.1 GHz | -143 dBm/Hz | -152 dBm/Hz |
| | > 3.1 to < 5.4 GHz | -138 dBm/Hz | -149 dBm/Hz |
| | 5.4 to 6 GHz | -133 dBm/Hz | -148 dBm/Hz |
| Pre-amp ON | | | |
| Image protect | < 100 MHz | | -162 dBm/Hz |
| | 100 MHz to < 2.7 GHz | -156 dBm/Hz | -161 dBm/Hz |
| | 2.7 to 4.4 GHz | -155 dBm/Hz | -160 dBm/Hz |
| | > 4.4 to < 5.6 GHz | -152 dBm/Hz | -157 dBm/Hz |
| | 5.6 to 6 GHz | -141 dBm/Hz | -154 dBm/Hz |
| Single | | | |
| Image protect | <1.1 GHz | -157 dBm/Hz | -161 dBm/Hz |
| | 1.1 to < 3.6 GHz | -154 dBm/Hz | -158 dBm/Hz |
| | 3.6 to 5 GHz | -151 dBm/Hz | -156 dBm/Hz |
| | > 5 to 6 GHz | -146 dBm/Hz | -153 dBm/Hz |

Third order intermodulation distortion (TOI) ²⁰

| Conversion type: auto | Frequency | TOI ²³ | | Distortion ²⁴ |
|---------------------------|--------------------|-------------------|-----------|--------------------------|
| | | Specification | Typical | Specification |
| Pre-amp OFF ²¹ | | | | |
| Pre-amp ON ²² | ≤ 400 MHz | +15 dBm | +20.5 dBm | -52 dBc |
| | > 400 MHz to 3 GHz | +18 dBm | +23 dBm | -52 dBc |
| | > 3 GHz | +20 dBm | +23.5 dBm | -52 dBc |
| Pre-amp ON ²² | ≤ 100 MHz | -9.9 dBm | -2.5 dBm | -56 dBc |
| | > 100 to 850 MHz | -7.9 dBm | +2 dBm | -58 dBc |
| | > 850 MHz to 2 GHz | -4.3 dBm | +5 dBm | -47 dBc |
| | > 2 to 3 GHz | -0.9 dBm | +7 dBm | -41 dBc |
| | > 3 to 6 GHz | +1 dBm | +5 dBm | -32 dBc |

19. Expected input level of -50 dBm. Mixer level offset +10 dB.

20. Two tone, 100 kHz tone spacing.

21. Expected input level -5 dBm. Mixer level offset +10 dB.

22. Expected input level -25 dBm. Mixer level offset +15 dB.

23. TOI = third order intercept. The TOI is given by the input tone level (in dBm) minus (distortion/2) where distortion is the relative level of the distortion tones in dBc.

24. Expected input level -10 dBm with preamp off and -30 dBm with preamp on.

Technical Specifications and Characteristics

Dynamic range (continued)

Second harmonic distortion (SHI)

| Conversion type: image protect | Frequency | SHI, nominal ²⁶ | Distortion, nominal ²⁷ |
|--------------------------------|------------|----------------------------|-----------------------------------|
| Pre-amp OFF ²⁵ | ≤ 1.35 GHz | +35 dBm | -45 dBc |
| | > 1.35 GHz | +95 dBm | -105 dBc |

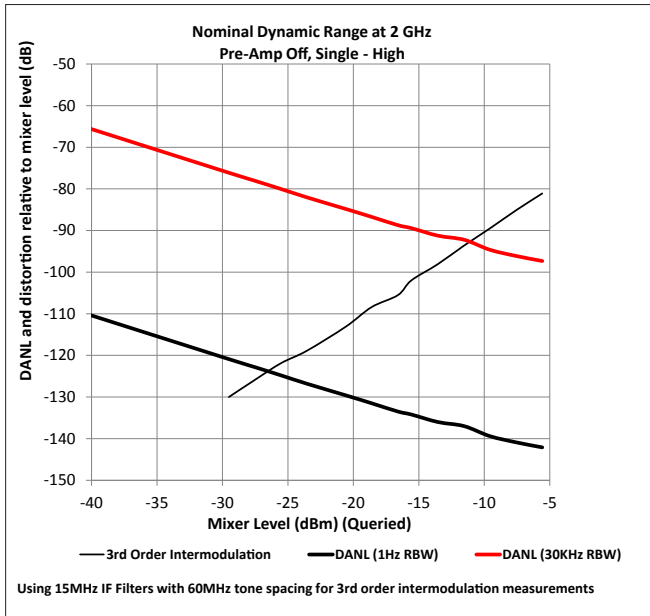

Figure 4. Dynamic range at 2 GHz, pre-amp OFF, single-high conversion type.

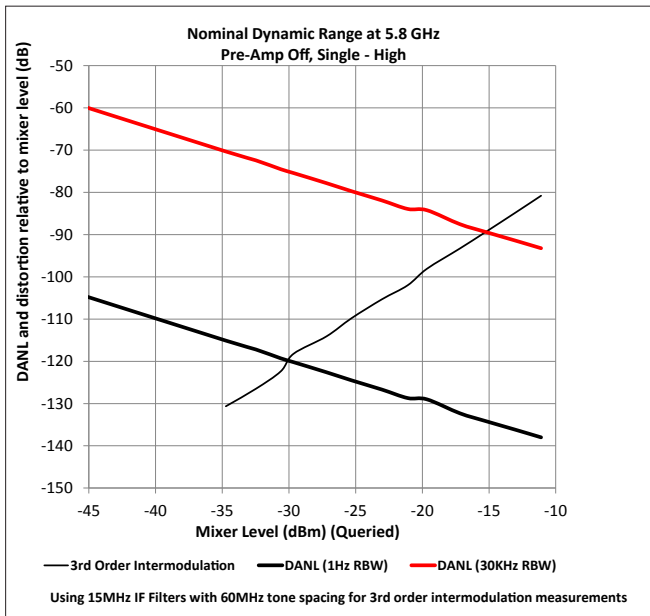

Figure 5. Dynamic range at 5.8 GHz, pre-amp OFF, single-high conversion type.

25. Expected input level -10 dBm. Mixer level offset +10 dB.

26. SHI = second harmonic intercept. The SHI is given by the input power in dBm minus the second harmonic distortion level relative to the input signal in dBc.

27. For 0 dBm input signal.

Technical Specifications and Characteristics

Dynamic range (continued)

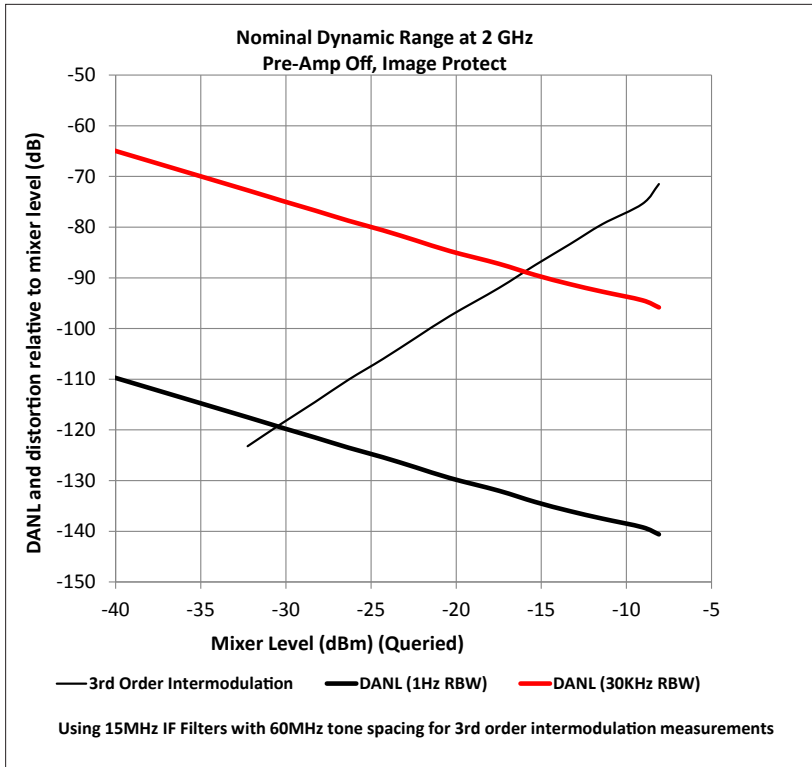

Figure 6. Dynamic range at 2 GHz, pre-amp OFF, image protect conversion type.

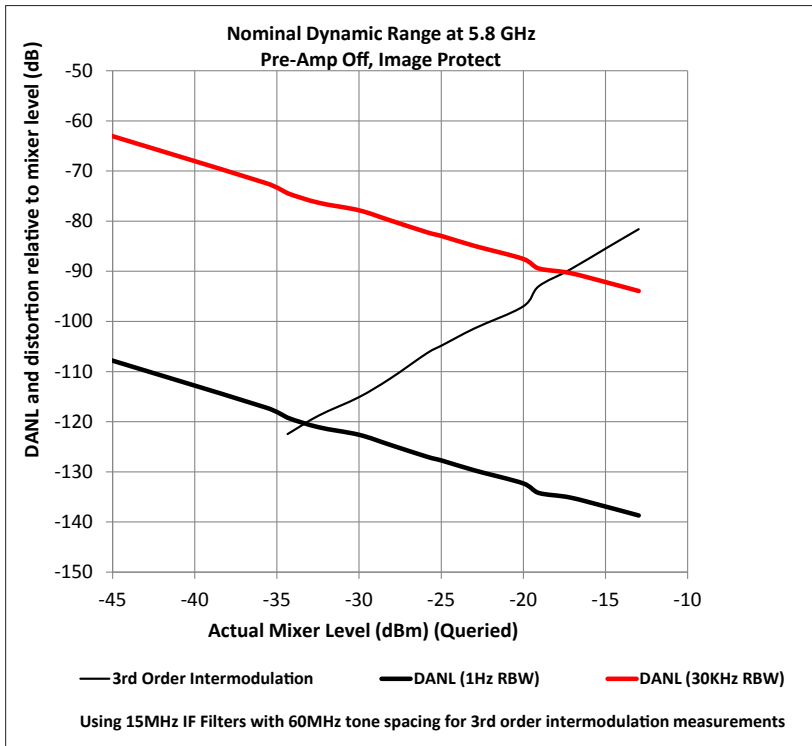

Figure 7. Dynamic range at 5.8 GHz, pre-amp OFF, image protect conversion type.

Technical Specifications and Characteristics

Spectral purity

Phase noise ²⁸

| Conversion type | Center frequency | Offset | Nominal |
|-----------------|------------------|--------|-------------|
| Single low | 1.1 GHz | 10 kHz | -120 dBc/Hz |
| Single high | 1 GHz | 10 kHz | -119 dBc/Hz |

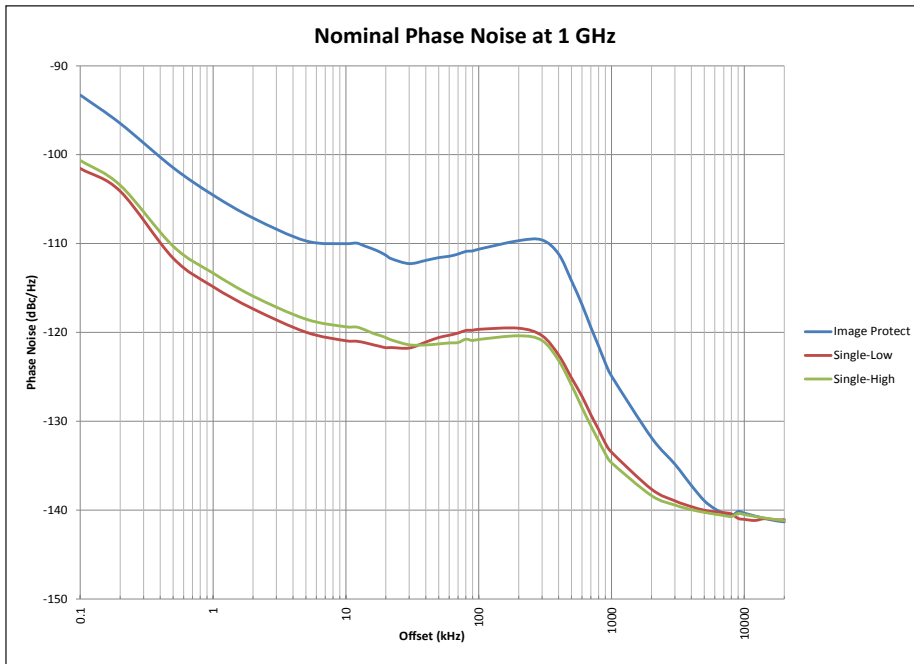

Figure 8. Phase noise at 1 GHz (1.1 GHz for single-low conversion type).

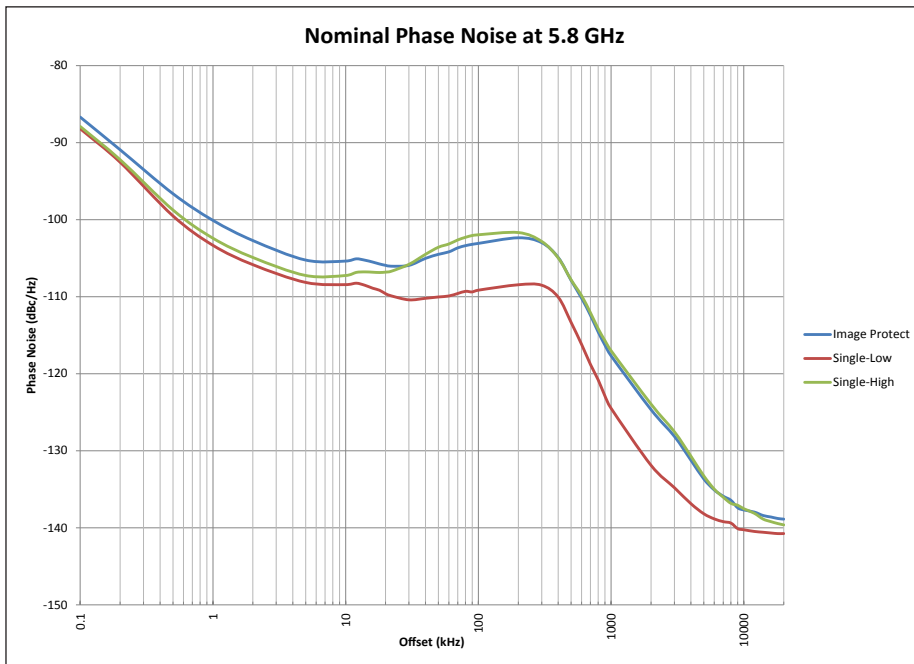

Figure 9. Phase noise at 5.8 GHz.

28. Mixer level offset +20 dB.

Technical Specifications and Characteristics

Spectral purity (continued)

| Residuals, images & spurious responses | | | |
|---|-----------------------------|--------------------|----------------|
| Non-input related spurs ²⁹ | Conversion type | Frequency | Nominal |
| Expected input level | | | |
| Pre-amp ON | | | |
| ≤ 0 dBm (measured at -50 dBm) | Single | All | < -120 dBm |
| | Image protect | All ³⁰ | < -120 dBm |
| Pre-amp OFF | | | |
| < +5 dBm (measured at -50 dBm) | Single | ≤ 3 GHz | < -120 dBm |
| | | > 3 GHz | < -116 dBm |
| | Image protect | All ³¹ | < -105 dBm |
| | | All ³² | < -90 dBm |
| ≥ +5 dBm (measured at +6 dBm) | Single | All | < -98 dBm |
| | Image protect | All ³² | < -90 dBm |
| LO related spurs ³³ | | | |
| | Offsets from carrier | Frequency | Nominal |
| | 200 to 10 kHz | All | -82 dBc |
| | 10 kHz to 10 MHz | All | -55 dBc |
| First order RF spurious responses ³⁴ | | | |
| | Offsets from carrier | Frequency | Nominal |
| | ≥ 10 MHz | ≥ 200 MHz to 6 GHz | -60 dBc |
| Higher order RF spurious responses ³⁴ | | | |
| | Offsets from carrier | Frequency | Nominal |
| | ≥ 10 MHz | ≥ 200 MHz to 6 GHz | -60 dBc |
| Image responses ³⁵ | | | |
| | Conversion type | Frequency | Nominal |
| | Image protect | All | < -68 dBc |
| IF rejection ³⁶ | | | |
| | IF bandwidth filter | Frequency | Nominal |
| 15 MHz | | ≤ 400 MHz | < -57 dBc |
| | | > 400 MHz | < -105 dBc |
| 40 MHz | | ≤ 450 MHz | < -57 dBc |
| | | > 450 MHz | < -98 dBc |
| 160 MHz | | All | < -85 dBc |
| LO emission ³⁷ | | | |
| | Conversion type | Frequency | Nominal |
| Single | | ≤ 3 GHz | -72 dBm |
| | | > 3 GHz | -62 dBm |
| Image protect | | All | -88 dBm |

29. Mixer level offset at 10 dB, input terminated, with 50Ω load.

30. From 4.72 to 4.88 GHz, specification at <-108 dBm, nominal.

31. From 4.72 to 4.88 GHz, specification at <-96 dBm, nominal.

32. From 4.72 to 4.88 GHz, specification at <-80 dBm, nominal.

33. Expected input level 0 dBm. Mixer offset level -10 dB.

34. Conversion type: image protect, pre-amp OFF, expected input level -20 dBm and mixer level offset 0 dB.

35. Excitation frequency: [F=2*Final IF] MHz, expected input level -20 dBm, mixer level offset -30 dB.

36. Suppression of signal at IF frequencies when tuned at least 2 x IF BW away.

All input paths, image protect, expected input level -30 dBm. Input signal at -30 dBm and mixer level offset 0 dB.

37. Expected input level -50 dBm. Mixer level offset +10 dB.

Technical Specifications and Characteristics

Data acquisition

| Maximum capture memory | Non-list mode | List mode |
|--|--|--|
| Option M01 | 128 MSample (512 MB) | 128 MSample (512 MB) |
| Option M05 | 512 MSample (2 GB) | 512 MSample (2 GB) |
| Option M10 | 1 GSample (4 GB) ³⁸ | 512 MSample (2 GB) to ~ 1 GSample (3.999 GB) ³⁹ |
| Segments | | |
| Minimum length | 1 sample ⁴⁰ | |
| Maximum length | Full capture memory ³⁸ | |
| Maximum sample rate | | |
| Option B04 / 40 MHz | 50 MS/s complex, 100 MS/s real | |
| Option B10 / 100 MHz | 125 MS/s complex, 250 MS/s real | |
| Option B16 / 160 MHz | 200 MS/s complex, 400 MS/s real | |
| List mode | | |
| Maximum number of segments | 3201 | |
| Trigger sources | External, magnitude | |
| Trigger modes | Per acquisition, interval timer trigger | |
| Triggering | | |
| Delay range ⁴¹ | -500 ms to +500 ms, <i>nominal</i> | |
| Delay resolution | 1 sample, <i>nominal</i> | |
| External trigger signal frequency range | 10 to 30 MHz for pulse | |
| External trigger signal level | TTL | |
| External trigger signal duty cycle range | 20% to 80% | |
| External trigger signal waveform | Sine, pulse/square, ramp (symmetry 0% to 100%) | |
| Channel-to-channel synchronization⁴² | | |
| | Timing | Phase |
| Skew | ≤ 400 ps, <i>nominal</i> | - |
| Jitter ⁴³ | ≤ 50 ps, <i>nominal</i> | $\leq 0.3^\circ$, <i>nominal</i> |
| Repeatability ⁴⁴ | ≤ 80 ps, <i>nominal</i> | $\leq 1.0^\circ$, <i>nominal</i> |
| Adjustment resolution ⁴⁵ | 50 ps | 0.05° |
| Drift over 12 hours | 20 ps, <i>nominal</i> | 0.5° , <i>nominal</i> |

38. The default mode for allocation of capture memory is AgM9391MemoryModeNormal, where the digitizer's memory is shared by both the default single acquisition (capture ID = 0) and all the other acquisitions with non-zero capture IDs. In particular, the memory for the default single acquisition is allocated from the area unused by the list acquisitions. If the available memory is not sufficient for the single acquisition, the user must release memory allocated for the non-zero capture ID acquisitions manually, thus increasing free space. Total memory usage is limited according to the memory option. Note that the maximum size of acquisition is 2 GB in this mode. To perform the default single acquisition with memory size larger than 2 GB, AgM9391MemoryModeLargeAcquisition must be selected. The non-zero capture ID acquisitions cannot be performed in this mode. All data acquired with AgM9391MemoryMode Normal will be invalidated.

39. The maximum size for a single list point capture is limited to 512 MSamples (2 GB). However, with option M10, total capture of up to 3.999 GB is available across all list mode captures.

40. 64-bit mode, 2 samples for 32-bit mode.

41. Negative trigger delay limited to capture size.

42. Multi-channel capability only supported with up to 8-channels when configured with a Keysight M9018A PXIe chassis with FPGA version 1.05 or greater. Characteristics measured at 400, 900, 2400, 5800 MHz and apply in Auto Conversion mode at frequencies ≥ 400 MHz with IF filter = 160 MHz. V2802A LO distribution network used for phase synchronization for more than 4 channels.

43. Jitter indicates measurement-to-measurement variation and applies over short time interval at room temperature without resetting or reinitializing a driver session.

44. Repeatability indicates stability of alignment between channels across power cycles and IVI sessions, with identical cabling and hardware settings (frequency, span, sample rate, etc.)

45. Channel time and phase offsets can be adjusted using OffsetDelay and OffsetPhase properties respectively.

Technical Specifications and Characteristics

Measurement speed⁴⁶

| IQ data capture ⁴⁷ | Nominal | |
|---|----------------|--|
| Large block (50 MSamples) | 1.5 s | Transferred in 100 kSa or 1 MSa blocks |
| Small block (100 captures, 100 ksamples each) | 292 ms | Transferred in 10 kSa blocks |
| Adjust level, freq (10 ksamples) | 1.7 ms | Transferred in 10 kSa blocks |

Power measurements ⁴⁸

| Channel power settings & filter bandwidth | Acquisition Time | Averages | Nominal |
|--|-------------------------|-----------------|----------------|
| 3.84 MHz | 400 μ s | None | 1.8 ms |
| | | 10 | 7.6 ms |
| | 100 μ s | None | 1.3 ms |
| | | 10 | 4.1 ms |
| | 50 μ s | None | 1.3 ms |
| | | 10 | 3.4 ms |
| 30 kHz | 100 μ s | None | 3.9 ms |
| | | 10 | 30.4 ms |

46. EVM, ACPR and servo loop test times for the RF power amplifier test, reference solution are included in the solution brochure 5991-4104EN.

47. Capture block, transfer to host memory, 160 MHz BW, excludes frequency transitions below 400 MHz, with M9037A embedded controller (2-link configuration: 1 x 8 [factory default]).

48. Transfer to host memory, 160 MHz IF bandwidth filter, excludes frequency transitions below 400 MHz, with M9037A embedded controller (2-link configuration: 1 x 8 [factory default]).

Noise Figure Measurement Application

| Description | Specifications | | Supplemental Information |
|---------------------|-------------------------|--------------------------|--|
| Noise figure | | | Uncertainty calculator ⁴⁹ |
| < 10 MHz | | | See footnote ⁵⁰ |
| 10 MHz to 6 GHz | | | Internal and external preamplification recommended ⁵¹ |
| | Noise source ENR | Measurement range | Instrument uncertainty⁵² |
| | 4 to 6.5 dB | 0 to 20 dB | ± 0.054 dB |
| | 12 to 17 dB | 0 to 30 dB | ± 0.102 dB |
| | 20 to 22 dB | 0 to 35 dB | ± 0.119 dB |

49. The figures given in the table are for the uncertainty added by the X-Series Signal Analyzer instrument only. To compute the total uncertainty for your noise figure measurement, you need to take into account other factors including: DUT NF, Gain and Match, Instrument NF, Gain Uncertainty and Match; Noise source ENR uncertainty and Match. The computations can be performed with the uncertainty calculator included with the Noise Figure Measurement Personality. Go to Mode Setup then select Uncertainty Calculator. Similar calculators are also available on the Keysight web site; go to <http://www.keysight.com/find/nfu>.

50. Uncertainty performance of the instrument is nominally the same in this frequency range as in the higher frequency range. However, performance is not warranted in this range. There is a paucity of available noise sources in this range, and the analyzer has poorer noise figure, leading to higher uncertainties as computed by the uncertainty calculator.

51. The NF uncertainty calculator can be used to compute the uncertainty. For most DUTs of normal gain, the uncertainty will be quite high without preamplification.

52. "Instrument Uncertainty" is defined for noise figure analysis as uncertainty due to relative amplitude uncertainties encountered in the analyzer when making the measurements required for a noise figure computation. The relative amplitude uncertainty depends on, but is not identical to, the relative display scale fidelity, also known as incremental log fidelity. The uncertainty of the analyzer is multiplied within the computation by an amount that depends on the Y factor to give the total uncertainty of the noise figure or gain measurement. See Keysight App Note 57-2, literature number 5952-3706E for details on the use of this specification. Jitter (amplitude variations) will also affect the accuracy of results. The standard deviation of the measured result decreases by a factor of the square root of the Resolution Bandwidth used and by the square root of the number of averages. This application uses the 4 MHz Resolution Bandwidth as default because this is the widest bandwidth with uncompromised accuracy.

| Description | Specifications | Supplemental Information |
|--------------------------------------|----------------|--|
| Gain | | |
| Instrument uncertainty ⁵³ | | DUT gain range = -20 to +40 dB. See note ⁵⁴ |
| < 10 MHz | | |
| 10 MHz to 6 GHz | ± 0.21 dB | |

53. "Instrument Uncertainty" is defined for gain measurements as uncertainty due to relative amplitude uncertainties encountered in the analyzer when making the measurements required for the gain computation. See Keysight App Note 57-2, literature number 5952-3706E for details on the use of this specification. Jitter (amplitude variations) will also affect the accuracy of results. The standard deviation of the measured result decreases by a factor of the square root of the Resolution Bandwidth used and by the square root of the number of averages. This application uses the 4 MHz Resolution Bandwidth as default since this is the widest bandwidth with uncompromised accuracy. Under difficult conditions (low Y factors), the instrument uncertainty for gain in high band can dominate the NF uncertainty as well as causing errors in the measurement of gain. These effects can be predicted with the uncertainty calculator.
54. Uncertainty performance of the instrument is nominally the same in this frequency range as in the higher frequency range. However, performance is not warranted in this range. There is a paucity of available noise sources in this range, and the analyzer has poorer noise figure, leading to higher uncertainties as computed by the uncertainty calculator.

| Description | Specifications | Supplemental Information |
|---|--|---|
| Noise figure uncertainty calculator⁵⁵ | | |
| Instrument noise figure uncertainty | See the noise figure table earlier in this chapter | |
| Instrument gain uncertainty | See the gain table earlier in this chapter | |
| Instrument noise figure | | See graphs of "nominal instrument noise figure"; noise figure is DANL + 176.24 dB (nominal) ⁵⁶ |
| Instrument input match | | See graphs: nominal VSWR |

55. The Noise Figure Uncertainty Calculator requires the parameters shown in order to calculate the total uncertainty of a Noise Figure measurement.
56. Nominally, the noise figure of the spectrum analyzer is given by $NF = D - (K - L + N + B)$ where D is the DANL (displayed average noise level) specification, K is kTB (-173.98 dBm in a 1 Hz bandwidth at 290 K) L is 2.51 dB (the effect of log averaging used in DANL verifications) N is 0.24 dB (the ratio of the noise bandwidth of the RBW filter with which DANL is specified to an ideal noise bandwidth) B is ten times the base-10 logarithm of the RBW (in hertz) in which the DANL is specified. B is 0 dB for the 1 Hz RBW. The actual NF will vary from the nominal due to frequency response errors.

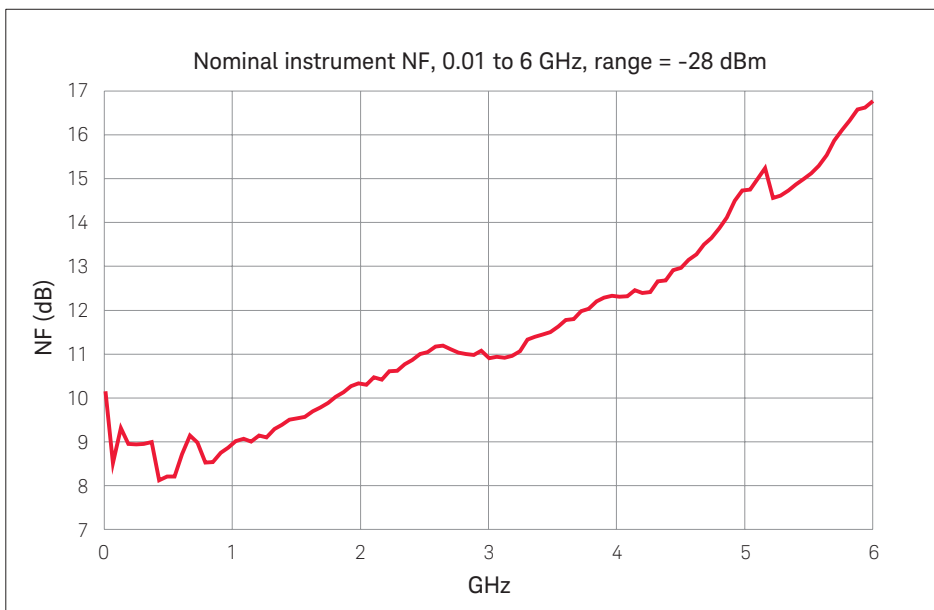

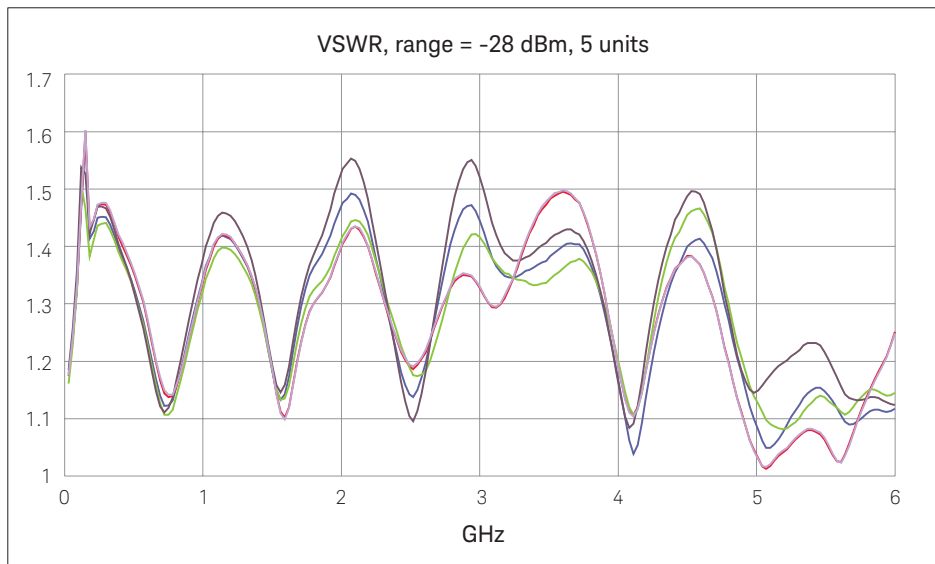

Format specific measurement data

GSM ^{57,58}

| | Parameters | Nominal |
|--------------------|----------------------------------|---------|
| Global phase error | 0.9, 1.8, 1.9, 2.0, 2.1, 2.2 GHz | 0.17 ° |
| ORFS dynamic range | 200 kHz offset | -36 dBc |
| | 250 kHz offset | -41 dBc |
| | 400 kHz offset | -69 dBc |
| | 600 kHz offset | -73 dBc |
| | 800 kHz offset | -77 dBc |
| | 1200 kHz offset | -80 dBc |
| | 1800 kHz offset | -78 dBc |

EDGE ^{57,58}

| | Parameters | Nominal |
|--------------------|----------------------------------|-----------|
| Residual EVM | 0.9, 1.8, 1.9, 2.0, 2.1, 2.2 GHz | 0.23% rms |
| ORFS dynamic range | 200 kHz offset | -37 dBc |
| | 250 kHz offset | -42 dBc |
| | 400 kHz offset | -69 dBc |
| | 600 kHz offset | -73 dBc |
| | 800 kHz offset | -77 dBc |
| | 1200 kHz offset | -80 dBc |
| | 1800 kHz offset | -77 dBc |

57. Synthesizer PLL mode set to PLL mode best wide offset.

58. Expected input level 0 dBm, input signal (total power) 0 dBm, mixer level offset +10 dB, conversion type: Auto, PeakToAverage set per signal peak to average.

Technical Specifications and Characteristics

Format specific measurement (continued)

| W-CDMA ^{59,60} | Parameters | | Typical | Nominal | | |
|------------------------------------|--|---------------------|-------------------|-------------------------|-------------------------|-------------------------|
| Residual EVM | 2 GHz, 1 DPCH, 1 carrier | | | 0.5% | | |
| ACLR dynamic range | 2 GHz, 1 DPCH, 1 carrier (power mode) | Adjacent | -68.1 dBc | -69.8 dBc | | |
| | | Alternate | -70.7 dBc | -71.7 dBc | | |
| 802.11g ^{59,60,64} | Parameters | | | Nominal | | |
| EVM | 2.4 GHz, 20 MHz BW | | | -52.8 dB | | |
| 802.11a ^{59,60,64} | Parameters | | | Nominal | | |
| EVM | 5.8 GHz, 20 MHz BW | | | -48.1 dB | | |
| 802.11n ^{59,60,64} | Parameters | | | Nominal | | |
| EVM | 2.4 GHz, 40 MHz BW | 1-channel | -52.0 dB | 2-channel ⁶² | 3-channel ⁶² | 4-channel ⁶² |
| | | 5.8 GHz, 40 MHz BW | -48.6 dB | -46.6 dB | -45.3 dB | -46.0 dB |
| EVM ⁶³ | 5.8 GHz, 80 MHz BW | 1-channel | -46.5 dB | 2-channel ⁶² | 3-channel ⁶² | 4-channel ⁶² |
| | | 5.8 GHz, 160 MHz BW | -44.7 dB | -43.4 dB | -41.7 dB | -43.3 dB |
| EVM ⁶³ | 5.8 GHz, 80 MHz BW | 1-channel | -49.4 dB | 2-channel ⁶² | 3-channel ⁶² | 4-channel ⁶² |
| | | 5.8 GHz, 160 MHz BW | -47.5 dB | -47.5 dB | -44.7 dB | -45.1 dB |
| SEM | 5.8 GHz, 80 MHz BW | see Figure 10 | | | | |
| 802.11a/g ^{62,60} | Parameters | | | Nominal | | |
| SEM | 2.4 GHz | see Figure 11 | | Preamble only | | |
| | | 5.5 GHz | see Figure 12 | | Preamble, pilots & data | |
| SEM | 2.4 GHz | see Figure 11 | | Preamble only | | |
| | | 5.5 GHz | see Figure 12 | | Preamble, pilots & data | |
| 802.11e ^{62,60,65} | Parameters | | | Nominal | | |
| OFDMA WiMAX™ EVM | 2.5, 3.5, & 5.8 GHz | | -48.3 dB, nominal | | | |

59. Synthesizer PLL mode set to PLL mode best wide offset.

60. Expected input level 0 dBm, input signal (total power) 0 dBm, conversion type: Auto. PeakToAverage set per signal peak to average.

61. Synthesizer PLL mode set to PLL mode normal.

62. Multi-channel performance data applies when each channel is configured with its own independent synthesizer. Sharing a single synthesizer will degrade EVM performance approximately 1 dB.

63. Mixer level offset = +5 dB

64. Mixer level offset = +10 dB

65. Mixer level offset = +15 dB

Technical Specifications and Characteristics

Format specific measurement (continued)

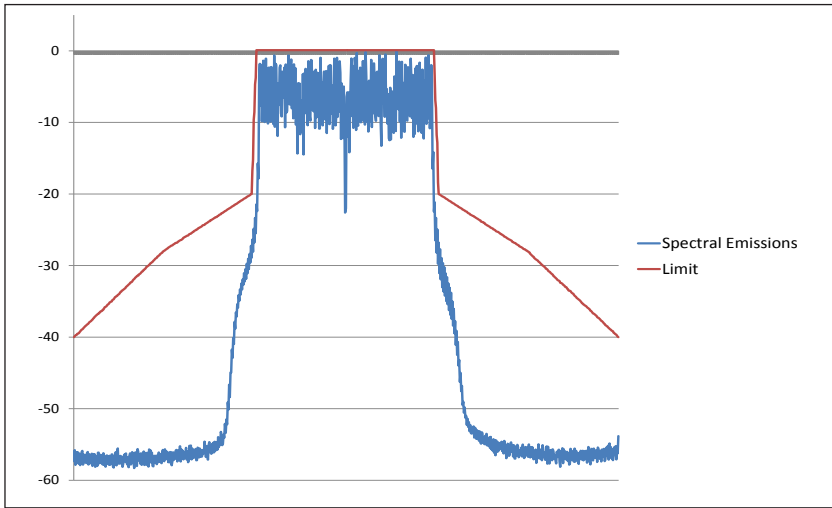

Figure 10. WLAN 802.11ac SEM at 5.8 GHz, 80 MHz bandwidth.

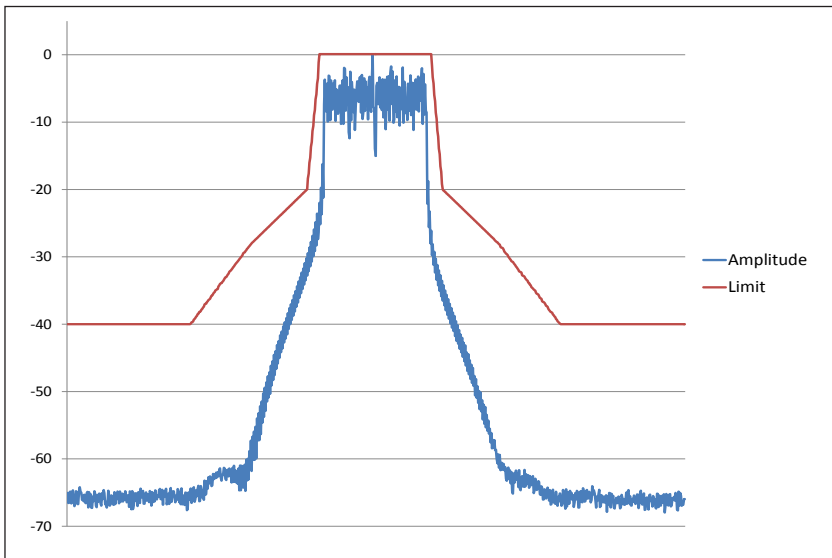

Figure 11. WLAN 802.11a/g SEM at 2.4 GHz, 20 MHz bandwidth.

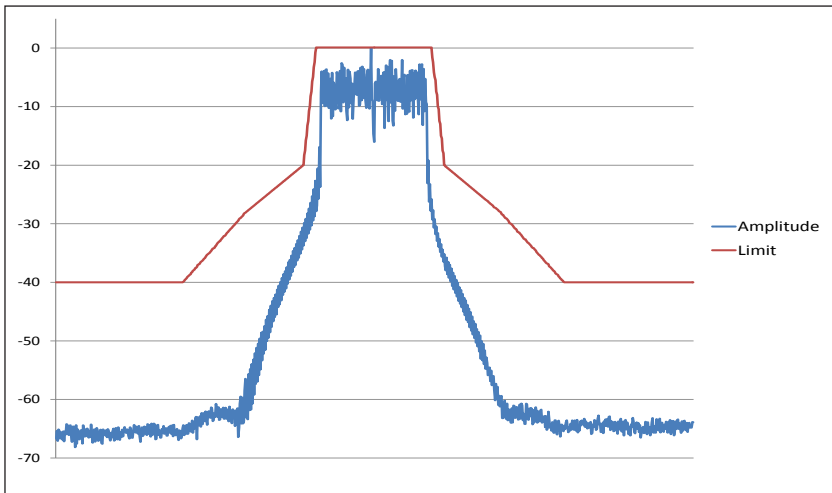

Figure 12. WLAN 802.11a/g SEM at 5.5 GHz, 20 MHz bandwidth.

Technical Specifications and Characteristics

Format specific measurement (continued)

| LTE FDD - single channel ^{66, 67} | Parameters | 1-channel, nominal | | |
|---|---|---|---|---|
| 10 MHz BW EVM, E-TM 3.1 ^{61, 62} | 0.7, 0.9 GHz | -52.2 dB (0.25%) | | |
| | 1.8, 1.9, 2.0, 2.1, 2.2 GHz | -51.0 dB (0.28%) | | |
| 10 MHz BW ACLR, E-TM 1.1 ⁶³ | 0.7, 0.9, 1.8, 1.9, 2.0, 2.1, 2.2 GHz (power mode) | Adjacent | -64.2 dBc | |
| | | Alternate | -65.5 dBc | |
| LTE FDD - MIMO ^{66, 67, 68} | Parameters | 2-channel, nominal ⁷² | 4-channel, nominal ⁷² | 8-channel, nominal ⁷³ |
| | 0.9 GHz | -49.8 dB (0.32%) | -50.1 dB (0.31%) | -52.6 dB (0.23%) |
| | 2.0 GHz | -49.2 dB (0.35%) | -49.3 dB (0.34%) | -48.8 dB (0.36%) |
| LTE TDD - MIMO ^{66, 67, 68} | Parameters | 2-channel, nominal ⁷² | 4-channel, nominal ⁷² | 8-channel, nominal ⁷³ |
| | 0.9 GHz | -50.7 dB (0.29%) | -50.3 dB (0.31%) | -56.3 dB (0.15%) |
| | 2.0 GHz | -49.0 dB (0.36%) | -49.0 dB (0.36%) | -54.8 dB (0.18%) |

66. Expected input level 0 dBm, input signal (total power) 0 dBm, conversion type: Auto. PeakToAverage set per signal peak to average.

67. Synthesizer PLL mode set to PLL mode normal.

68. Multi-channel performance data applies when each channel is configured with its own independent synthesizer. Sharing a single synthesizer will degrade EVM performance approximately 1 dB.

69. PDCCH power boost = 1.065 dB

70. Mixer level offset = +10 dB

71. Mixer level offset = +15 dB

72. 10 MHz BW EVM, R9 downlink, 64 QAM, open loop spatial multiplexing

73. 10 MHz BW, DL, TM9 multi-layer, TM4 closed loop spatial multiplexing

Technical Specifications and Characteristics

Environmental and physical specifications

| | | | | |
|-------------------------------|--|---|-------|--------|
| Temperature | Operating | Individual module temp 25 to 75 °C as reported by the module and environment temp of 0 to 55 °C | | |
| | Non-operating (storage) | Environment temp of -40 to +70 °C | | |
| Humidity ⁷⁴ | Type tested at 95%, +40 °C (non-condensing) | | | |
| Shock/vibration ⁷⁴ | Operating random vibration | Type tested at 5 to 500 Hz, 0.21 g rms | | |
| | Survival random vibration | Type tested at 5 to 500 Hz, 2.09 g rms | | |
| | Functional shock | Type tested at half-sine, 30 g, 11 ms | | |
| | Bench handling | Type tested per MIL-PRF-28800F | | |
| Altitude | Up to 15,000 feet (4,572 meters) ⁷⁵ | | | |
| Connectors | RF In | SMA female | | |
| EMC | Complies with European EMC Directive 2004/108/EC | | | |
| | <ul style="list-style-type: none"> - IEC/EN 61326-2-1 - CISPR Pub 11 Group 1, class A - AS/NZS CISPR 11 - ICES/NMB-001 This ISM device complies with Canadian ICES-001. Cet appareil ISM est conforme a la norme NMB-001 du Canada. | | | |
| Warm-up time | 45 minutes | | | |
| Size | M9300A | 1 PXIe slot | | |
| | M9301A | 1 PXIe slot | | |
| | M9350A | 1 PXIe slot | | |
| | M9214A | 1 PXIe slot | | |
| Dimensions | Module | Length | Width | Height |
| | M9300A | 210 mm | 22 mm | 130 mm |
| | M9301A | 210 mm | 22 mm | 130 mm |
| | M9350A | 210 mm | 22 mm | 130 mm |
| | M9214A | 210 mm | 22 mm | 130 mm |
| Weight | M9300A | 0.55 kg (1.21 lbs) | | |
| | M9301A | 0.54 kg (1.19 lbs) | | |
| | M9350A | 0.56 kg (1.23 lbs) | | |
| | M9214A | 0.36 kg (0.79 lbs) | | |
| Power drawn from chassis | M9300A | ≤ 18 W | | |
| | M9301A | ≤ 25 W | | |
| | M9350A | ≤ 30 W | | |
| | M9214A | ≤ 35 W | | |

74. Samples of this product have been type tested in accordance with the Keysight Environmental Test Manual and verified to be robust against the environmental stresses of storage, transportation and end-use--those stresses include but are not limited to temperature, humidity, shock, vibration, altitude and power-line conditions. Test methods are aligned with IEC 60068-2 and levels are similar to MIL-PRF-28800F Class 3.

75. At 15,000 feet, the maximum environmental temperature is de-rated to 52 °C.

Technical Specifications and Characteristics

System requirements

| Topic | Windows 7 requirements |
|---|--|
| Operating systems | Windows 7 (32-bit and 64-bit) |
| Processor speed | 1 GHz 32-bit (x86), 1 GHz 64-bit (x64) (no support for Itanium 64) |
| Available memory | 4 GB minimum 8 GB or greater recommended |
| Available disk space ⁷⁶ | 1.5 GB available hard disk space, includes: 1 GB available for Microsoft .NET Framework 3.5 SP1 ⁷⁷ 100 MB for Keysight IO Libraries Suite |
| Video | Support for DirectX 9 graphics with 128 MB graphics memory recommended (Super VGA graphics is supported) |
| Browser | Microsoft Internet Explorer 7 or greater |
| M9391A vector signal analyzer instrument drivers | |
| Keysight IO libraries | Version 16.3.17914 or greater |

76. Because of the installation procedure, less disk space may be required for operation than is required for installation.

77. NET Framework Runtime Components are installed by default with Windows 7. Therefore, you may not need this amount of available disk space.

Software

Instrument connection software



Keysight IO library

The IO library suite offers a single entry point for connection to the most common instruments including AXIe, PXI, GPIB, USB, Ethernet/LAN, RS-232, and VXI test instruments from Keysight and other vendors. It automatically discovers interfaces, chassis, and instruments. The graphical user interface allows you to search for, verify, and update IVI instrument and soft front panel drivers for modular and traditional instruments. The IO suite safely installs in side-by-side mode with NI I/O software.

Free software download at www.keysight.com/find/iosuite

Module setup and usage

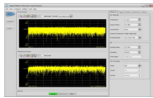

Keysight soft front panel

The PXI module includes a soft front panel (SFP), a software-based graphical user interface (GUI) which enables the instrument's capabilities from your PC.

Included on CD-ROM shipped with module or [online](#)

Module management

Keysight connection expert

Connection expert is the graphical user interface included in the IO libraries suite that allows you to search for, verify and update IVI instrument and soft front panel drivers for modular and traditional instruments

Free software download at www.keysight.com/find/iosuite

Programming

Driver

IVI-COM, IVI-C
LabVIEW, MATLAB

Development environments

Visual Studio (VB.NET, C#, C/C++), VEE
LabVIEW, LabWindows/CVI, MATLAB

Included on CD-ROM shipped with module.

Programming assistance



Command expert

Assists in finding the right instrument commands and setting correct parameters. A simple interface includes documentation, examples, syntax checking, command execution, and debug tools to build sequences for integration in Excel, MATLAB, Visual Studio, LabVIEW, VEE, and SystemVue.

Free software download at www.keysight.com/find/commandexpert

Programming examples

Each module includes programming examples for Visual Studio, LabVIEW, MATLAB, LabWindows, and Keysight VEE Pro.

Included on CD-ROM shipped with module.

Signal analysis software

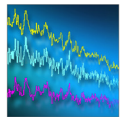

X-Series measurement applications for modular instruments

The X-Series measurement applications transform modular PXI VSAs into standards based RF transmitter testers. Provides conformance measurements for many communications standards including : LTE, WLAN 802.11ac and others.

Licensed software.
For more information, visit www.keysight.com/find/pxi-x-series_apps

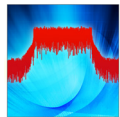

89600 VSA

89600 VSA software sees through the complexity of emerging and existing industry standards, serving as your window into complex signal interactions. Quickly characterize spurs and harmonics with speed-optimized stepped spectrum measurement provided by 89601B-SSA option.

Licensed software.
For more information, visit www.keysight.com/find/vsa



SystemVue

SystemVue is a system-level EDA platform for designing communications and defense systems. Used with the M9391A, SystemVue enables you to create model-based design validation tests to ensure consistency from design to manufacturing.

Licensed software.
For more information, visit www.keysight.com/find/systemvue

Setup and Calibration Services

Assistance

| | | |
|----------------------------|--|--------------------------------|
| One day startup assistance | Gain access to a technical expert who will help you get started quickly with the M9391A PXI VSA and its powerful software tools. The flexible instruction format is designed to get you to your first measurements and familiarize you with ways to adapt the equipment to a specific application. | Included in base configuration |
|----------------------------|--|--------------------------------|

Calibration and traceability

| | | |
|--|--|---|
| Factory calibration | The M9391A PXI VSA ships factory calibrated with an ISO-9002, NIST-traceable calibration certificate. | Included in base configuration |
| Calibration cycle | A one year calibration cycle is recommended. | |
| Calibration sites | <ul style="list-style-type: none"> - At Keysight worldwide service centers - On-site by Keysight - By self-maintainers | For more information visit www.keysight.com/find/infoline |
| N7800A calibration and adjustment software | The M9391A PXI VSA is supported by Keysight's calibration and adjustment software. This is the same software used at Keysight service centers to automate calibration. The software offers compliance tests for ISO 17025:2005, ANSI/NCSL Z540.3-2006, and measurement uncertainty per ISO Guide to Expression of Measurement Uncertainty. | Licensed software. For more information, visit www.keysight.com/find/calibrationsoftware |
| Keysight calibration status utility | The Keysight calibration status utility helps ensure your M9391A is calibrated by managing the calibration interval and providing messages regarding instrument and module calibration status. | Included in base configuration |

Support and Warranty

Warranty

| | | |
|---|--|----------|
| Global warranty | Keysight's warranty service provides standard coverage for the country where product is used. – All parts and labor necessary to return to full specified performance – Recalibration for products supplied originally with a calibration certificate – Return shipment | Included |
| Standard | Return to Keysight warranty–3 years 15 days typical turnaround repair service | Included |
| R-51B-001-5Z | Return to Keysight warranty–5 years 15 days typical turnaround repair service | Optional |
| R-51B-001-3X Express warranty 3 years | The express warranty upgrades the global warranty to provide, for 3 years, a 5 day typical turnaround repair service in the US, Japan, China and many EU countries. | Optional |
| R-51B-001-5X Express warranty 5 years | The express warranty upgrades the global warranty to provide, for 5 years, a 5 day typical turnaround repair service in the US, Japan, China and many EU countries. | Optional |

Support

| | | |
|-----------------------|---|---|
| Core exchange program | Keysight's replacement core exchange program allows fast and easy module repairs. A replacement core assembly is a fully functioning pre-calibrated module replacement that is updated with the defective module serial number, allowing the replacement module to retain the original serial number. | For qualified self-maintainers in US only |
| Self-test utility | A self-test utility runs a set of internal tests which verifies the health of the modules and reports their status. | Included in base configuration |

Configuration and Ordering Information

Ordering information

| Model | Description |
|---------------------------|---|
| M9391A | PXIe vector signal analyzer: 1 MHz to 3 or 6 GHz Includes: M9301A PXIe synthesizer M9350A PXIe downconverter M9214A PXIe IF digitizer One day startup assistance Module interconnect cables Software, example programs and product information on CD Return to Keysight warranty—3 Years |
| Base configuration | |
| M9391A-F03 | Frequency range: 1 MHz to 3 GHz |
| M9391A-B04 | Analysis bandwidth, 40 MHz |
| M9391A-M01 | Memory, 128 MSa |
| M9391A-300 | PXIe frequency reference: 10 and 100 MHz Required for warranted specifications Adds M9300A PXIe frequency reference: 10 and 100 MHz (M9300A module can support multiple M9391A modular instruments) |

For configurations of the M9391A PXI VSA, including combinations with a single or multiple M9381A PXI VSGs, please consult the M9391A & M9381A configuration guide, literature number **5991-0897EN**.

| Configurable options | |
|--|---|
| Frequency | |
| M9391A-F03 | 1 MHz to 3 GHz |
| ✓ M9391A-F06 | 1 MHz to 6 GHz |
| Switching speed | |
| ✓ M9391A-UNZ | Fast switching |
| Analysis bandwidth | |
| M9391A-B04 | 40 MHz |
| M9391A-B10 | 100 MHz |
| ✓ M9391A-B16 | 160 MHz |
| Memory | |
| M9391A-M01 | 128 MSa |
| M9391A-M05 | 512 MSa |
| ✓ M9391A-M10 | 1024 MSa |
| Other | |
| M9391A-012 | Phase coherency |
| M9391A-UK6 | Commercial calibration certificate with test data for M9391A (M9301A, M9350A, M9214A) |
| M9300A-UK6 | Commercial calibration certificate with test data for M9300A (module only) |
| Related products in recommended configuration | |
| ✓ M9037A | PXIe embedded controller |
| ✓ M9018A | 18-slot PXIe chassis |

✓ Indicates recommended configuration

Configuration and Ordering Information

Software information

| | |
|--|--|
| Supported operating systems | Microsoft Windows 7 (32/64-bit) |
| Standard compliant drivers | IVI-COM, IVI-C, LabVIEW, MATLAB |
| Supported application development environments (ADE) | VisualStudio (VB.NET, C#, C/C++), VEE, LabVIEW, LabWindows/CVI, MATLAB |
| Keysight IO libraries (version 16.3 or newer) | Includes: VISA libraries, Keysight Connection Expert, IO monitor |
| Keysight Command Expert | Instrument control for SCPI or IVI-COM drivers |
| 89600 VSA Software (version 17.21 or newer; Option SSA added in version 18.5) | 89600B-200 Basic VSA software 89601B-300 Hardware connectivity 89601B-SSA Spectrum analysis 89601B-AYA GP analysis 89601B-B7T cdma2000®/1xEV-DO 89601B-B7U W-CDMA/HSPA+ 89601B-B7R WLAN 802.11a/b/g/j/p 89601B-B7X TD-SCDMA 89601B-BHD LTE FDD 89601B-BHG LTE FDD - Advanced 89601B-BHE LTE TDD 89601B-BHH LTE TDD - Advanced |
| X-Series Measurement Applications for Modular Instruments transportable perpetual license. | M9063A Analog demodulation M9064A Vector signal analysis M9071A GSM/EDGE/Evo M9072A cdma2000®/cdmaOne M9073A W-CDMA/HSPA+ M9076A 1xEV-DO M9077A WLAN 802.11a/b/g/n/ac M9079A TD-SCDMA/HSDPA M9080B LTE/LTE-A FDD M9081A Bluetooth® M9082B LTE/LTE-A TDD |

Accessories

| Model | Description |
|--------|---|
| Y1212A | Slot blocker kit: 5 modules |
| Y1213A | PXI EMC filler panel kit: 5 slots |
| Y1299A | PXI solutions startup kits |
| Y1243A | Cable kit for M9301A LO distribution |
| M9021A | PCIe® cable interface |
| M9045B | PCIe express card adaptor for laptop connectivity |
| Y1200B | PCIe cable for laptop connectivity |
| M9048A | PCIe desktop adaptor for desktop connectivity |
| Y1202A | PCIe cable for desktop connectivity |

Related products

| Model | Description |
|--------|------------------------------|
| M9381A | PXIe vector signal generator |
| M9380A | PXIe CW source |
| M9300A | PXIe frequency reference |
| M9018A | PXIe 18-slot chassis |
| M9037A | PXIe embedded controller |

Advantage services: Calibration and warranty

Keysight Advantage Services is committed to your success throughout your equipment's lifetime

| | |
|--------------|---------------------------------------|
| R-51B-001-5Z | Return to Keysight warranty - 5 years |
| R-51B-001-3X | Express warranty - 3 years |
| R-51B-001-5X | Express warranty - 5 years |
| N7800A | Calibration & adjustment software |

Evolving

Our unique combination of hardware, software, support, and people can help you reach your next breakthrough. **We are unlocking the future of technology.**

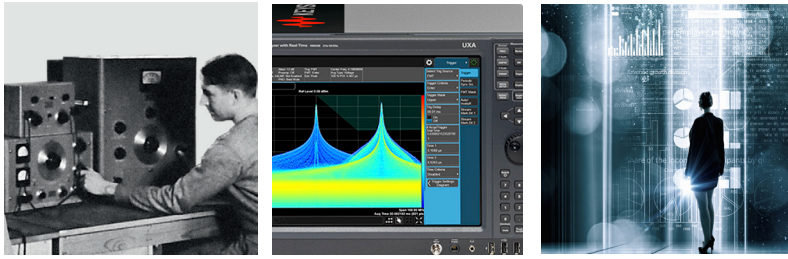

From Hewlett-Packard to Agilent to Keysight

myKeysight

myKeysight

www.keysight.com/find/mykeysight

A personalized view into the information most relevant to you.

KEYSIGHT SERVICES

Accelerate Technology Adoption.
Lower costs.

Keysight Services

www.keysight.com/find/service

Our deep offering in design, test, and measurement services deploys an industry-leading array of people, processes, and tools. The result? We help you implement new technologies and engineer improved processes that lower costs.



Three-Year Warranty

www.keysight.com/find/ThreeYearWarranty

Keysight's committed to superior product quality and lower total cost of ownership. Keysight is the only test and measurement company with three-year warranty standard on all instruments, worldwide. And, we provide a one-year warranty on many accessories, calibration devices, systems and custom products.



Keysight Assurance Plans

www.keysight.com/find/AssurancePlans

Up to ten years of protection and no budgetary surprises to ensure your instruments are operating to specification, so you can rely on accurate measurements.

Keysight Channel Partners

www.keysight.com/find/channelpartners

Get the best of both worlds: Keysight's measurement expertise and product breadth, combined with channel partner convenience.

www.keysight.com/find/m9391a

www.keysight.com/find/modular

For more information on Keysight Technologies' products, applications or services, please contact your local Keysight office. The complete list is available at: www.keysight.com/find/contactus

Americas

| | |
|---------------|------------------|
| Canada | (877) 894 4414 |
| Brazil | 55 11 3351 7010 |
| Mexico | 001 800 254 2440 |
| United States | (800) 829 4444 |

Asia Pacific

| | |
|--------------------|----------------|
| Australia | 1 800 629 485 |
| China | 800 810 0189 |
| Hong Kong | 800 938 693 |
| India | 1 800 11 2626 |
| Japan | 0120 (421) 345 |
| Korea | 080 769 0800 |
| Malaysia | 1 800 888 848 |
| Singapore | 1 800 375 8100 |
| Taiwan | 0800 047 866 |
| Other AP Countries | (65) 6375 8100 |

Europe & Middle East

| | |
|----------------|---------------|
| Austria | 0800 001122 |
| Belgium | 0800 58580 |
| Finland | 0800 523252 |
| France | 0805 980333 |
| Germany | 0800 6270999 |
| Ireland | 1800 832700 |
| Israel | 1 809 343051 |
| Italy | 800 599100 |
| Luxembourg | +32 800 58580 |
| Netherlands | 0800 0233200 |
| Russia | 8800 5009286 |
| Spain | 800 000154 |
| Sweden | 0200 882255 |
| Switzerland | 0800 805353 |
| | Opt. 1 (DE) |
| | Opt. 2 (FR) |
| | Opt. 3 (IT) |
| United Kingdom | 0800 0260637 |

For other unlisted countries:

www.keysight.com/find/contactus
(BP-2-23-17)



www.keysight.com/go/quality

Keysight Technologies, Inc.
DEKRA Certified ISO 9001:2015
Quality Management System



Unlocking Measurement Insights

This information is subject to change without notice.
© Keysight Technologies, 2013 - 2017
Published in USA, April 29, 2017
5991-2603EN
www.keysight.com