

Keysight Technologies USB Modular Products

Data Sheet



Introduction

The Keysight Technologies Inc. compact USB modular products are a series of modules that are flexible to be used standalone or plugged into a compatible chassis to make synchronized measurements as a modular unit. Essential measurements can be made with a laptop PC and these modules through USB high-speed 2.0 connections. Through individual windows, the Keysight Measurement Manager (KMM) software provides a friendly soft front-panel interface for each of the modular products. This helps to perform quick configuration and measurement acquisition as well as flexible analysis of measured data.



Simple setup with USB Hi-Speed 2.0 and bundled software



Portable and compact

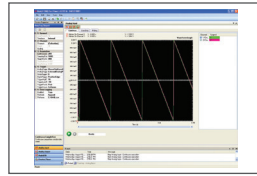

Easy to program with KMM software, IVI drivers, and a wide range of Application Development Environment compatibility



Flexibility with standalone/modular capability

Overview

Table of Contents

Overview	3
Keysight U2781A USB Modular Product Chassis	7
Keysight Measurement Manager.....	12
Keysight USB Modular Data Acquisition Modules	13
U2300A Series USB Modular Multifunction Data Acquisition Devices.....	14
U2500A Series USB Modular Simultaneous Sampling Multifunction DAQ Devices	25
U2600A Series USB Modular Isolated Digital I/O Devices	33
U2802A 31-Channel Thermocouple Input Device	37
Optional Accessories for USB Modular DAQ.....	44
Keysight USB Modular Test Instrument Modules	46
U2701A and U2702A USB Modular Oscilloscope.....	47
U2722A/U2723A USB Modular Source Measure Unit	54
U2741A USB Modular Digital Multimeter	58
U2751A USB Modular Switch Matrix	64
U2761A Function/Arbitrary Waveform Generator	68
Ordering Information	74

Keysight U2781A USB Modular Product Chassis



Features:

- Expansion of channels for each modular products
- Multiple instrument synchronization
- Internal and external 10 MHz reference clock
- High-speed USB 2.0
- SSI/Star trigger bus synchronization between external trigger source and modules

Keysight Measurement Manager

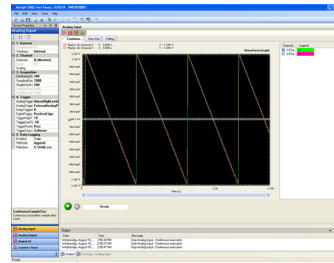

The Keysight Measurement Manager is a bundled software that comes with the standard purchase of a USB modular DAQ, USB modular instrument, or the U2781A USB modular product chassis.

Keysight USB Modular Data Acquisition (DAQ) Family

U2300A Series USB Modular Multifunction DAQ



Features:

- High analog input sampling rate coverage of up to 3 MSa/s for a single channel
- High analog input up to 64 channels
- High speed USB 2.0
- Multifunction capabilities – analog input (AI), analog output (AO), digital input output (DIO), and counter

U2600A Series USB Modular Isolated Digital I/O



Features:

- 64 opto-isolated lines that can meet demand up to 24 V
- High speed USB 2.0
- Isolation voltage of 1250 Vrms for protection from transient voltage spikes

U2500A Series USB Modular Simultaneous Sampling Multifunction DAQ



Features:

- High analog input sampling rate coverage of up to 2 MSa/s for each channel
- High speed USB 2.0
- Simultaneous acquisition of multiple data points
- Multifunction capabilities – analog input (AI), analog output (AO), digital input output (DIO), and counter

Signal Conditioner U2802A 31-Channel Thermocouple Input Device



Features:

- 31 input channels that can be independently configured
- Error detection for open thermocouple channels
- Built-in isothermal construction on terminal block
- Auto-zeroing function
- Works with U2355A and U2356A USB modular DAQ

Optional Accessories

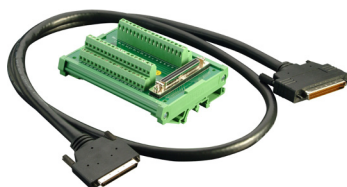

Features:

- U2901A and U2902A terminal block and SCSI-II 68-pin connector with 1-meter/2-meter cable for U2300A Series and U2500A Series
- U2903A and U2904A terminal block and SCSI-II 100-pin connector with 1-meter/2-meter cable for U2600A Series

Keysight USB Modular Test Instruments Family

U2701A/U2702A USB Modular Oscilloscope



Features:

- High sampling rate up to 500 MSa/s, enables accurate measurement analysis
- Up to 32 MB large memory
- Fast fourier transfer (FFT) and waveform math functions enables easy waveform calculation

U2722A/U2723A USB Modular Source Measure Unit



Features:

- Four-quadrant source/measure operation
- 16-bit resolution for all voltage and current ranges with high measurement sensitivity
- High accuracy
- Embedded test script (for U2723A)
- IV Curve application support in Keysight Measurement Manager (for U2723A)
- Faster rise/fall time (for U2723A)

U2741A USB Modular Digital Multimeter (DMM)



Features:

- Fast reading speed (up to 100 Sa/s)
- Wide range of basic measurement functions, including frequency and temperature measurements

U2751A USB Modular Switch Matrix



Features:

- Minimal cross-talk of -30 dB at 45 MHz wide bandwidth
- High bandwidth at 45 MHz without terminal block
- Capability to test up to four devices-under-test (DUTs)
- Works with other Keysight instruments for multi-point testing

U2761A USB Modular Function/Arbitrary Waveform Generator



Features:

- Direct digital synthesis (DDS) waveform generator
- Pulse generator that can generate pulse signal as stimulus
- Easy customization with Arbitrary Waveform Editor
- Internal modulation capability simplifies test setup

Ease of Use

The Keysight USB modular products are equipped with Hi-Speed USB 2.0 interfaces for easy setup, plug-and-play, and hot swappable connectivity. With the quick and easy USB connectivity, the USB modular products are simple enough for academic applications and yet robust and versatile enough for industrial laboratory applications. Simplifying this further is the Keysight Measurement Manager software that offers a simple interface for quick setup, configuration, and measurement control.

Flexible Standalone or Modular Capability

The USB modular products are uniquely designed for the flexibility of functioning as a standalone or modular unit. You can reduce your startup cost by using the USB modular product as a standalone unit. On the other hand, using the USB modular product as a modular unit, you will be able to expand your application system – in terms of channel count and functionality – by slotting in various modular units into the U2781A.

Easy-to-use bundled software and the command logger function

The Keysight Measurement Manager application software provides you with a quick and easy means to configure and control your device without requiring any programming work. Simplifying this further is the command logger function offered in the Keysight Measurement Manager that allows capturing of configuration commands that can be easily converted to snippets of VEE code. Other supported languages are VB, C++, and C#.

Compatible with a Wide Range of Application Development Environments

The Keysight USB modular products are compatible with a wide range of application development environments. This minimizes the time that R&D and manufacturing engineers need to use the devices in different software environments.

Listed below are the popular development environments and tools with which the USB modular oscilloscope is compatible:

- Keysight VEE and Keysight T&M Toolkit
- Microsoft Visual Studio.NET, C/C++, and Visual Basic 6
- MATLAB
- LabVIEW
- Microsoft .NET Framework

Modules	LabView	LabWindows/CVI	MatLab	IVI	SCPI
U2300A Series USB Modular Multifunction DAQ	<input type="checkbox"/>		<input type="checkbox"/>	<input type="checkbox"/>	<input type="checkbox"/>
U2500A Series USB Modular Simultaneous Sampling Multi-function DAQ	<input type="checkbox"/>		<input type="checkbox"/>	<input type="checkbox"/>	<input type="checkbox"/>
U2600A Series USB Modular Isolated Digital I/O	<input type="checkbox"/>		<input type="checkbox"/>	<input type="checkbox"/>	<input type="checkbox"/>
U2701A/U2702A USB Modular Oscilloscope	<input type="checkbox"/>			<input type="checkbox"/>	
U2722A/U2723A USB Modular Source Measure Unit	<input type="checkbox"/>	<input type="checkbox"/>		<input type="checkbox"/>	<input type="checkbox"/>
U2741A USB Modular Digital Multimeter (DMM)	<input type="checkbox"/>	<input type="checkbox"/>		<input type="checkbox"/>	<input type="checkbox"/>
U2751A USB Modular Switch Matrix	<input type="checkbox"/>	<input type="checkbox"/>		<input type="checkbox"/>	<input type="checkbox"/>
U2761A USB Modular Function/Arbitrary Waveform Generator	<input type="checkbox"/>	<input type="checkbox"/>		<input type="checkbox"/>	<input type="checkbox"/>



Keysight U2781A USB Modular Product Chassis

Features

- Internal and external 10 MHz reference clock
- Simultaneous Synchronization Interface (SSI)
- Star trigger
- External trigger-in and trigger-out signals
- Temperature and fan speed monitoring
- Compatible with Hi-Speed
- USB 2.0 and USBTMC-USB488 standards
- Bundled software – Keysight Measurement Manager (KMM)
- Rackmount kit available as an option

Introduction

The Keysight U2781A USB modular product chassis is a high-performance 4U chassis that comes with a 200 W universal AC power supply and a built-in protection circuit. This portable chassis can house up to six Keysight USB modular products. The U2781A targets a wide range of applications in both industrial and scientific environments in the research and development (R&D), design-validation, and manufacturing fields. The primary advantage of this chassis is its synchronization capability between modules. This can help you to lower your cost of testing and accelerate your test system integration and development.

The U2781A is equipped with an internal 10 MHz reference clock for each module slot. There are two temperature sensors to monitor the internal temperature and a built-in fan to maintain the internal temperature. The trigger bus enables the USB modular products to trigger signals to each other.



Supported products

The chassis supports the following USB modular products:

- USB modular data acquisition (DAQ) including:
 - U2300 Series USB modular multifunction DAQ devices
 - U2500 Series USB modular simultaneous sampling multifunction DAQ devices
 - U2600 Series USB modular isolated digital I/O devices
- USB modular instruments including:
 - U2701A/U2702A USB modular oscilloscope
 - U2722A/U2723A USB modular source measure unit
 - U2741A USB modular digital multimeter
 - U2751A USB modular switch matrix
 - U2761A USB modular function/arbitrary generator

High-density data acquisition

The U2781A chassis increases the number of available channels when any U2300 Series, U2500 Series, or U2600 Series products are slotted into the chassis. For example, when you slot six U2331A Series products in the chassis, it allows for an expansion of up to 384 channels, providing a high-density data acquisition solution.

Internal and external 10 MHz reference clock

The U2781A is equipped with a 10 MHz reference clock. It is used to synchronize the timebase of the USB modular products slot into the chassis for more precise measurements.

Simultaneous Synchronization Interface (SSI)

SSI provides synchronization between the modular products in the chassis by allowing the modules to be configured as Master or Slave. The Master module sends the SSI signal to the Slave module via the backplane trigger bus. Then, the Slave module receives the signal and begins synchronization with the Master module. There are two SSI configuration modes available – single Master-multiple Slaves and multiple Masters-multiple Slaves. Please refer to the *Keysight U2781A USB Modular Product Chassis User's Guide* for more information.

Triggering using Star trigger bus

The U2781A comes with a Star trigger bus, which offers precise synchronization between USB modular products and the external trigger signal. The star trigger bus provides dedicated trigger lines between the external trigger input and slotted USB modules. You can also achieve precise triggering between each USB modular product via the synchronized routing of the star trigger.

System option

The U2781A USB modular product chassis has a mountable rackmount kit, which can be ordered separately (see “Optional Accessories” on page 8). This allows for a better setup when the U2781A is integrated into a test system.

Simultaneous Synchronization Interface (SSI) capability

The table below shows the USB modular products triggering capability.

Modular products	Configure as Master ¹	Configure as Slave ²
U2300A Series	Yes	Yes
U2500A Series	Yes	Yes
U2600A Series	Yes	Yes
U2701A/U2702A ³	Yes	Yes
U2722A/U2723A ³	Yes ⁴	Yes
U2741A	No	Yes
U2751A	No	No
U2761A	Yes	Yes

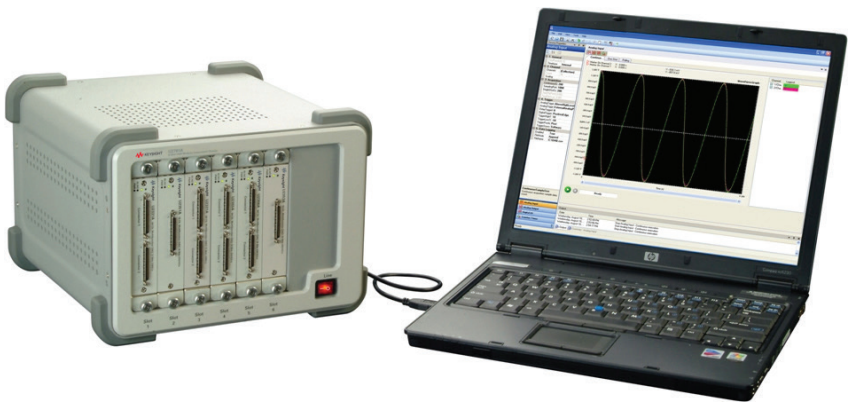

¹ The Master module sends the SSI trigger-out signal to the Slave module via the backplane trigger bus.

² The Slave module receives the SSI trigger-in signal and begins synchronization with the Master module.

³ U2722A/U2723A cannot trigger U2701A/U2702A and vice versa.

⁴ Triggering can only be done through SCPI command.

Product outlook and dimensions

Front view



Rear view

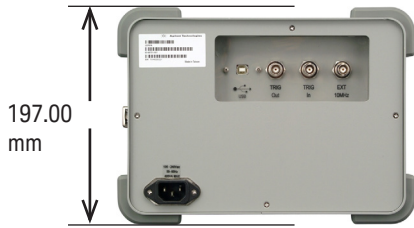

Top view

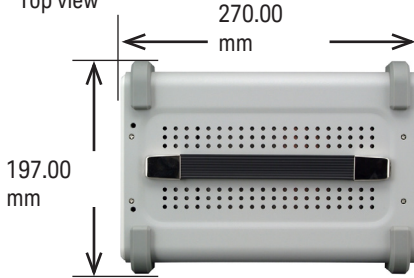

Standard shipped accessories

- Power cord
- USB extension cable
- L-Mount kit (used with modular product chassis)
- Keysight Automation-Ready CD-ROM (contains the Keysight IO Libraries Suite)
- Keysight U2781A USB Modular Product Chassis Quick Start Guide
- Keysight USB Modular Products Reference CD-ROM
- Functional Test Certificate

Optional accessories

- U2905A rackmount kit for U2781A six-slot USB modular instrument chassis

Product characteristics and general specifications

REMOTE INTERFACE

- Hi-Speed USB 2.0*
- USBTMC-USB488⁵

POWER CONSUMPTION

- 400 VA maximum
- Installation Category II

OPERATING ENVIRONMENT

- Operating temperature from 0 °C to +55 °C
- Operating humidity at 15% to 85% RH (non-condensing)
- Altitude up to 2000 meters
- Pollution Degree 2
- For indoor use only

STORAGE COMPLIANCE

-20 °C to 70 °C

SAFETY COMPLIANCE

Certified with:

- IEC 61010-1:2001/EN 61010-1:2001 (2nd Edition)
- USA: UL61010-1: 2004
- Canada: CSA C22.2 No.61010-1:2004

EMC COMPLIANCE

- IEC/EN 61326-1 1998
- CISPR 11: 1990/EN55011:1991, Class A, Group 1
- Canada: ICES-001:1998
- Australia/New Zealand: AS/NZS 2064.1

ACOUSTIC EMISSION

- Sound pressure level: 45.5 dB(A)
- Sound power level: 56.6 dB(A)

SHOCK AND VIBRATION

Tested to IEC/EN 60068-2

DIMENSION (W × D × H)

270.00 mm × 271.20 mm × 197.00 mm (with bumpers)

WEIGHT

3.7 kg (without any modules slotted in)

⁵ Compatible with Microsoft Windows operating systems only.

*If remote connections are necessary, a E5813A USB/LAN hub can be used. Please go to the product's user guide for more information.

Electrical specifications

Power supply AC input	
Input voltage range	100 to 240 VAC
Input frequency range	50 to 60 Hz
Power consumption	400 VA maximum
Efficiency	75%
Power supply DC output	
Output rated voltage	12 VDC
Max output rated current	16.7 A
Max output rated power	200 W
Over voltage protection	13.2 to 16.2 V
Internal 10 MHz reference clock	
Accuracy	25 ppm for operating range
Slot to slot skew	350 ps
External 10 MHz reference clock	
Auto detection level	Yes
Input frequency range	10 MHz
Input magnitude	100 mVpp to 5 Vpp (sine/square wave)
Input impedance	50 $\Omega \pm 5 \Omega$
Damage level	10 Vrms
External trigger in	
Compatibility	TTL
VIH (Positive threshold voltage)	2.0 V
VIL (Negative threshold voltage)	0.8 V
Hold time	8 ns pulse width
Input voltage range	0 V to 5.0 V
Slot to slot skew	350 ps
External trigger out	
VOH	2.9 V
VOL	0.1 V
Output voltage range	0 V to 3.3 V

Mechanical specifications

Physical layout	
Number of USB module slots	6
Dimension of each module slot	25.40 mm (W) x 174.54 mm (D) x 105.00 mm (H)
Dimension of chassis	270.00 mm (W) x 271.20 mm (D) x 197.00 mm (H)
Weight	3.7 kg
Power LED	ON/OFF type
USB backplane	
Connector	55-pin Ethernet male type C
Input signals	External 10 MHz clock in (BNC connector) External trigger in (BNC connector)
Output signal	Trigger out (BNC connector)
Cooling fan	
Number of fans	2
Fan speed	3300 rpm \pm 10%
Noise	37 dB(A)
Power (each fan)	2.52 W

Keysight Measurement Manager

The Keysight Measurement Manager (KMM) is an application software that comes with the standard purchase of the U2300A Series, U2500A Series, U2600A Series USB modular DAQ, or U2700A Series USB modular instruments. The KMM is also bundled with the U2781A USB modular product chassis. This software is designed to help you perform quick device configuration, data logging, and data acquisition through the products.

Supported Features	Modular DAQ				Modular Instruments				
	U2300A	U2500A	U2600A	U2802A	U2701A U2702A	U2722A U2723A	U2741A	U2751A	U2761A
Averaging	<input type="checkbox"/>	<input type="checkbox"/>	<input type="checkbox"/>	<input type="checkbox"/>	<input type="checkbox"/>				
Command logger ¹	<input type="checkbox"/>	<input type="checkbox"/>	<input type="checkbox"/>	<input type="checkbox"/>	<input type="checkbox"/>	<input type="checkbox"/>	<input type="checkbox"/>	<input type="checkbox"/>	<input type="checkbox"/>
Self-test		<input type="checkbox"/>	<input type="checkbox"/>		<input type="checkbox"/>	<input type="checkbox"/>		<input type="checkbox"/>	<input type="checkbox"/>
Self-calibration	<input type="checkbox"/>	<input type="checkbox"/>		<input type="checkbox"/>	<input type="checkbox"/>	<input type="checkbox"/>	<input type="checkbox"/>		<input type="checkbox"/>
Option to save the current instrument configuration to a file	<input type="checkbox"/>	<input type="checkbox"/>	<input type="checkbox"/>	<input type="checkbox"/>	<input type="checkbox"/>	<input type="checkbox"/>	<input type="checkbox"/>	<input type="checkbox"/>	<input type="checkbox"/>
Data logging and export feature to CSV, HTML and text only format files that can be printed	<input type="checkbox"/>	<input type="checkbox"/>	<input type="checkbox"/>	<input type="checkbox"/>	<input type="checkbox"/>	<input type="checkbox"/>	<input type="checkbox"/>		<input type="checkbox"/>
Data viewer to load and review previously logged data	<input type="checkbox"/>	<input type="checkbox"/>	<input type="checkbox"/>	<input type="checkbox"/>					
Trigger settings between modules in the instrument chassis with Star trigger and Master/Slave trigger	<input type="checkbox"/>	<input type="checkbox"/>	<input type="checkbox"/>	<input type="checkbox"/>	<input type="checkbox"/>	<input type="checkbox"/>	<input type="checkbox"/>		<input type="checkbox"/>
Synchronization display and data logging for modules in the instrument chassis	<input type="checkbox"/>	<input type="checkbox"/>	<input type="checkbox"/>	<input type="checkbox"/>					

Keysight Measurement Manager Prerequisites

Prior to installing the Keysight Measurement Manager software, ensure that your PC meets the following minimum system requirements for installation and operations.

Hardware Requirements

Processor	1.6 GHz Pentium IV or higher
Operating System	One of the following Microsoft Windows versions: <ul style="list-style-type: none"> - Windows XP Professional or Home edition (Service Pack 1 or later) - Windows Vista 32-bit (Business, Ultimate, Enterprise, Home Basic, and Home Premium edition) - Windows 7 32-bit (Professional, Ultimate, Enterprise, Home Basic, and Home Premium Edition) - Windows 7 (64-bit) support for 32-bit application running on a WOW64 (Windows-on-Windows 64-bit) emulator.
Hard Disk Space	1 GB
RAM	512 MB or higher recommended
Video	Super VGA (800 x 600), 256 colors or more

Software Requirements

- Keysight IO Libraries Suite 15.0 or higher¹
- Keysight T&M Toolkit Runtime version 2.1²
- Keysight T&M Toolkit Redistributable Package 2.1 patch²
- Microsoft.NET Framework version 2.0²

¹ Available on the *Keysight Automation-Ready CD-ROM*.

² Bundled with Keysight Measurement Manager software application installer.

Keysight USB Modular Data Acquisition Modules

The USB data acquisition (DAQ) family gives you the choice and flexibility to create solutions that evolve and expand according to your changing measurement needs. You can quickly and easily acquire, measure, and analyze data from electrical, mechanical, physical, and acoustical phenomena.

The DAQ series includes multifunction measurement modules, simultaneous-sampling measurement modules, two types of digital input/output (DIO) devices, and a thermocouple input.

A quick reference to the Keysight USB DAQ family

Features	U2300A Series multifunction DAQ devices	U2500A Series simultaneous sampling DAQ devices	U2600A Series isolated DIO devices	U2802A thermocouple input device ²
Number of models	7	3	3	1
Analog input				
Channels/module, max	64	4	-	31
Sampling rate, max	Up to 3 MSa/s (single channel) Up to 1 MSa/s ¹	Up to 2 MSa/s/chn	-	Up to 500 kSa/s
Resolution	Up to 16-bit	Up to 16-bit	-	Up to 16-bit
Input voltage, max	10 V	10 V	-	10 V
Simultaneous sampling	-	<input type="checkbox"/>	-	-
On-board memory	8 MSa	8 MSa	-	-
Thermocouple signal conditioning	-	-	-	<input type="checkbox"/>
Analog output				
Channels/module, max	2	2	-	2
Update rate, max	1 MSa/s	1 MSa/s	-	1 MSa/s
Resolution	Up to 16-bit	12-bit	-	12-bit
Output voltage, max	10 V	10 V	-	10 V
Digital I/O				
Channels/module, max	24	24	64	-
Input levels, max	5 V	5 V	24 V	-
Output levels, max	5 V	5 V	35 V	-
Counter				
Channels	2	2	-	-
Max count	(2 ³¹ -1) bits	(2 ³¹ -1) bits	-	-
Software and drivers				
Keysight Measurement Manager	<input type="checkbox"/>	<input type="checkbox"/>	<input type="checkbox"/>	<input type="checkbox"/>
IVI-COM	<input type="checkbox"/>	<input type="checkbox"/>	<input type="checkbox"/>	<input type="checkbox"/>
Keysight VEE	<input type="checkbox"/>	<input type="checkbox"/>	<input type="checkbox"/>	<input type="checkbox"/>
Compatibility with U2781A	<input type="checkbox"/>	<input type="checkbox"/>	<input type="checkbox"/>	-
Synchronization between modules	<input type="checkbox"/>	<input type="checkbox"/>	<input type="checkbox"/>	-

¹ Aggregate sampling rate.

² Works with U2355A and U2356A models.

U2300A Series USB Modular Multifunction Data Acquisition Devices

Features

- Up to 3 MSa/s sampling rate for a single channel
- Functions as a standalone or modular unit
- Easy to use: Plug-and-play and hot-swappable with Hi-Speed USB 2.0
- Up to 384 channels when incorporated into U2781A Keysight modular product chassis
- Easy-to-use bundled software for quick setup and data logging to PC
- 12-bit or 16-bit analog-to-digital (A/D) resolution
- 24-bit programmable digital input/output
- Self-calibration capability
- Compatible with a wide range of Application Development Environments
- USB 2.0 and USBTMC-USB488 standards

Introduction

The Keysight U2300A Series USB modular multifunction data-acquisition (DAQ) devices offer a high-performance PC data-acquisition solution. The U2300A Series DAQ devices consist of two families: basic multifunction DAQ and high-density multifunction DAQ. The basic multifunction DAQ family comes in four models, while the high-density multifunction DAQ family is made up of three models. The U2300A Series DAQ devices applications extend across industrial and education environments. The DAQ device is well suited for research and development, manufacturing, and design-validation engineers who require measurement devices with fast sampling rate.

High sampling rate

The U2300A Series DAQ devices have sampling rates of up to 3 MSa/s for a single channel. When multiple channels are configured, they can sample data up to 1 MSa/s. This fast sampling capability allows users to perform intermittent detection easily. This is ideal for dealing with high-density analog input/output signals, especially with different input ranges and sampling requirements.

Flexible standalone or modular capability

The U2300A Series DAQ devices are uniquely designed to be flexible enough to function as standalone unit or as part of a modular unit. When used with the U2781A modular product chassis, the devices can support up to 384 channels.

Flexible system and control options with polling and continuous mode

The U2300A Series DAQ devices provide two modes, polling mode and continuous mode. Selecting continuous mode enables you to acquire data continuously once the trigger signal is received.

Arbitrary waveform

U2300A Series supports arbitrary waveform, which allows you to generate arbitrary waveform via Keysight Measurement Manager application software or SCPI commands.



Burst mode

Burst mode is an enhancement feature of U2300 Series DAQ that enables the DAQ to simulate in simultaneous mode for analog input acquisition. This enables you to perform sampling measurement up to the highest speed the DAQ is capable of reaching.

Trigger sources

U2300 Series offers immediate trigger (none), analog/external digital trigger, System Synchronous Interface (SSI)/Star trigger, and Master/Slave trigger sources. All these trigger options give you the capability to configure trigger sources during A/D and digital-to-analog (D/A) operations. Master/Slave trigger and SSI/Star trigger are recommended when USB modules are slotted into the Keysight U2781A USB modular product chassis.

Predefined function generator

The two analog output channels offered not only provide DC voltage but also are capable of generating common and predefined waveforms such as sinusoidal wave, square wave, triangle wave, sawtooth wave, and noise wave.

Product outlook and dimensions

Front view

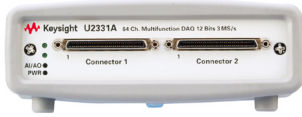

Rear view



Top view

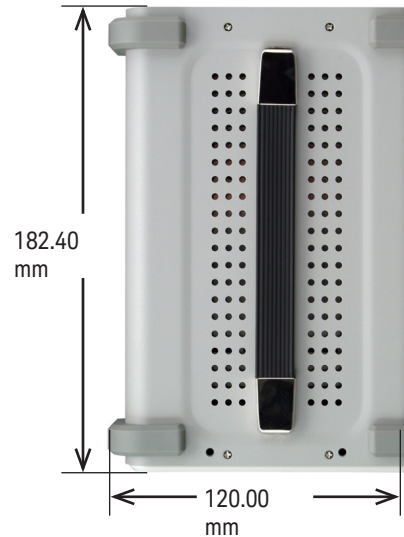

Standard shipped accessories

- AC/DC Power adapter
- Power cord
- USB extension cable
- L-Mount kit (used with modular product chassis)
- Keysight USB Modular Products Quick Start Guide
- Keysight USB Modular Products Reference CD-ROM
- Keysight Automation-Ready CD-ROM (contains the Keysight IO Libraries Suite)
- Certificate of Calibration

Optional accessories

- U2901A Terminal block and SCSI-II 68-pin connector with 1-meter cable
- U2902A Terminal block and SCSI-II 68-pin connector with 2-meter cable

Product characteristics and general specifications

REMOTE INTERFACE

- Hi-Speed USB 2.0*
- USBTMC-USB488¹

POWER REQUIREMENT

- +12 VDC (TYPICAL)
- 2 A (MAX) input rated current

POWER CONSUMPTION

+12 VDC, 550 mA maximum

OPERATING ENVIRONMENT

- Operating temperature from 0 °C to +55 °C
- Relative humidity at 15% to 85% RH (non-condensing)
- Altitude up to 2000 meters
- Pollution Degree 2
- For indoor use only

STORAGE COMPLIANCE

-20 °C to 70 °C

SAFETY COMPLIANCE

Certified with:

- IEC 61010-1:2001/EN 61010-1:2001 (2nd Edition)
- USA: UL61010-1: 2004
- Canada: CSA C22.2 No.61010-1:2004

EMC COMPLIANCE

- IEC/EN 61326-1 1998
- CISPR 11: 1990/EN55011:1991, Class A, Group 1
- Canada: ICES-001: 1998
- Australia/New Zealand: AS/NZS 2064.1

SHOCK AND VIBRATION

Tested to IEC/EN 60068-2

IO CONNECTOR

68-pin female VHDCI Type

DIMENSION (W × D × H)

Module dimension:

- 120.00 mm × 182.40 mm × 44.00 mm (with plastic casing)
- 105.00 mm × 174.54 mm × 25.00 mm (without plastic casing)

Terminal block dimension:

- 103.00 mm × 85.20 mm × 42.96 mm

WEIGHT

- 565 g (with plastic casing)
- 400 g (without plastic casing)

¹ Compatible with Microsoft Windows operating systems only.

*If remote connections are necessary, a E5813A USB/LAN hub can be used. Please go to the product's user guide for more information.

Electrical specifications

Basic multifunction USB DAQ

Model number	U2351A	U2352A	U2353A	U2354A
Analog input				
Resolution	16 bits, no missing codes			
Number of channels	16 SE/8 DI (software selectable/channel)			
Maximum sampling rate ¹	250 kSa/s		500 kSa/s	
Scan list memory	Up to 100 selectable channel entries			
Programmable bipolar input range	±10 V, ±5 V, ±2.5 V, ±1.25 V			
Programmable unipolar input range	0 to 10 V, 0 to 5 V, 0 to 2.5 V, 0 to 1.25 V			
Input coupling	DC			
Input impedance	1 GΩ / 100 pF			
Operational common mode voltage range	±7.5 V _{maximum}			
Overvoltage protection	Power-on: Continuous ±30 V, Power-off: Continuous ±15 V			
Trigger sources	External analog/digital trigger, SSI/Star trigger ²			
Trigger modes	Pre-trigger, delay-trigger, post-trigger, and middle-trigger			
FIFO buffer size	Up to 8 MSa			
Analog output				
Resolution	16 bits	-	16 bits	-
Number of channels	2	-	2	-
Maximum update rate	1 MSa/s	-	1 MSa/s	-
Output ranges	0 to 10 V, ±10 V, 0 to AO_EXT_REF, ±AO_EXT_REF ³	-	0 to 10 V, ±10 V, 0 to AO_EXT_REF, ±AO_EXT_REF ³	-
Output coupling	DC	-	DC	-
Output impedance	0.1 Ω typical	-	0.1 Ω typical	-
Stability	Any passive load up to 1500 pF	-	Any passive load up to 1500 pF	-
Power-on state	0 V steady state	-	0 V steady state	-
Trigger sources	External analog/digital trigger, SSI/Star trigger ²	-	External analog/digital trigger, SSI/Star trigger ²	-
Trigger modes	Post-trigger and delay-trigger	-	Post-trigger and delay-trigger	-
FIFO buffer size	One channel: Maximum 8 MSa Two channels: Maximum 4 MSa/ch	-	One channel: Maximum 8 MSa Two channels: Maximum 4 MSa/ch	-
Function generation mode	Sine, square, triangle, sawtooth, and noise waveforms	-	Sine, square, triangle, sawtooth, and noise waveforms	-

Basic multifunction USB DAQ (continued)

Digital I/O	
Number of channels	24-bit programmable input/output
Compatibility	TTL
Input voltage	$V_{IL} = 0.7 \text{ V max}$, $I_{IL} = 10 \text{ } \mu\text{A max}$ $V_{IH} = 2.0 \text{ V min}$, $I_{IH} = 10 \text{ } \mu\text{A max}$
Input voltage range	-0.5 V to +5.5 V
Output voltage	$V_{OL} = 0.45 \text{ V max}$, $I_{OL} = 8 \text{ mA max}$ $V_{OH} = 2.4 \text{ V min}$, $I_{OH} = 400 \text{ } \mu\text{A max}$
General purpose digital counter	
Maximum count	$(2^{31}-1)$ bits
Number of channels	Two independent up/down counter
Compatibility	TTL
Clock source	Internal or external
Base clock available	48 MHz
Maximum clock source frequency	12 MHz
Input frequency range ⁴	0.1 Hz to 6 MHz at 50% duty cycle
Pulse width measurement range	0.167 μs to 178.956 s
Analog trigger	
Trigger source	All analog input channels, External analog trigger (EXTA_TRIG)
Trigger level	\pm Full scale for internal; $\pm 10 \text{ V}$ for external
Trigger conditions	Above high, below low, and window (software selectable)
Trigger level resolution	8 bits
Bandwidth	400 kHz
Input impedance for EXTA_TRIG	20 k Ω
Coupling	DC
Overvoltage protection	Continuous for $\pm 35 \text{ V}_{\text{maximum}}$
Digital trigger	
Compatibility	TTL/CMOS
Response	Rising or falling edge
Pulse width	20 ns minimum
Calibration⁵	
On board reference voltage	5 V
Temperature drift	$\pm 2 \text{ ppm}/^{\circ}\text{C}$
Stability	$\pm 6 \text{ ppm}/1000 \text{ hrs}$
General	
Remote interface	Hi-Speed USB 2.0
Device class	USBTMC-USB488
Programmable interface	Standard Commands for Programmable Instruments (SCPI) and IVI-COM

¹ When multiple channels are used, the sampling rate of each channel is the maximum sampling rate divided by the number of channels used.

² System Synchronous Interface (SSI) and Star trigger commands are used when modular devices are used in the product chassis.

³ Maximum external reference voltage for analog output channels (AO_EXT_REF) is $\pm 10 \text{ V}$.

⁴ Measurement frequency's resolution:

$$= 12 \text{ MHz}/n, n = 2, 3, 4, 5, \dots, 120 \text{ M}$$

$$= 6 \text{ MHz}, 4 \text{ MHz}, 3 \text{ MHz}, 2.4 \text{ MHz}, 2.0 \text{ MHz}, \dots, 0.1 \text{ Hz (up to six decimal points)}$$

⁵ 20 minutes warm-up time is recommended.

High density multifunction USB DAQ

Model number	U2355A	U2356A	U2331A
Analog input			
Resolution	16 bits, no missing codes		12 bits, no missing codes
Number of channels	64 SE/32 DI (software selectable/channel)		
Maximum sampling rate ¹	250 kSa/s	500 kSa/s	3 MSa/s (single channel) 1 MSa/s (multiple channels)
Scan list memory	Up to 100 selectable channel entries		
Programmable bipolar input range	±10 V, ±5 V, ±2.5 V, ±1.25 V		±10 V, ±5 V, ±2.5 V, ±1.25 V, ±1 V, ±0.5 V, ±0.25 V, ±0.2 V, ±0.05 V
Programmable unipolar input range	0 to 10 V, 0 to 5 V, 0 to 2.5 V, 0 to 1.25 V		0 to 10 V, 0 to 5 V, 0 to 4 V, 0 to 2.5 V, 0 to 2 V, 0 to 1 V, 0 to 0.5 V, 0 to 0.4 V, 0 to 0.1V
Input coupling	DC		
Input impedance	1 GΩ / 100 pF		
Operational common mode voltage range	±7.5 V maximum		
Overvoltage protection	Power-on: Continuous ±30 V, Power-off: Continuous ±15 V		
Trigger sources	External analog/digital trigger, SSI/Star trigger ²		
Trigger modes	Pre- trigger, delay-trigger, post-trigger, and middle-trigger		
FIFO buffer size	Up to 8 MSa		
Analog output			
Resolution	12 bits		
Number of channels	2		
Maximum update rate	1 MSa/s		
Output ranges	0 to 10 V, ±10 V, 0 to AO_EXT_REF, ±AO_EXT_REF ³		
Output coupling	DC		
Output impedance	0.1 Ω Typical		
Stability	Any passive load up to 1500 pF		
Power-on state	0 V steady state		
Trigger sources	External analog/digital trigger, SSI/Star trigger ²		
Trigger modes	Post-trigger and delay-trigger		
FIFO buffer size	One channel: Maximum 8 MSa Two channels: Maximum 4 MSa/ch		
Function generation mode	Sine, square, triangle, sawtooth, and noise waveforms		
Digital I/O			
Number of bits	24-bit programmable input/output		
Compatibility	TTL		
Input voltage	$V_{IL} = 0.7 \text{ V max}$, $I_{IL} = 10 \text{ } \mu\text{A max}$ $V_{IH} = 2.0 \text{ V min}$, $I_{IH} = 10 \text{ } \mu\text{A max}$		
Input voltage range	-0.5 V to +5.5 V		
Output voltage	$V_{OL} = 0.45 \text{ V max}$, $I_{OL} = 8 \text{ mA max}$ $V_{OH} = 2.4 \text{ V min}$, $I_{OH} = 400 \text{ } \mu\text{A max}$		

High density multifunction USB DAQ (continued)

General purpose digital counter	
Maximum count	$(2^{31} - 1)$ bits
Number of channels	Two independent up/down counter
Compatibility	TTL
Clock source	Internal or external
Base clock available	48 MHz
Maximum clock source frequency	12 MHz
Input frequency range ⁴	0.1 Hz to 6 MHz at 50% duty cycle
Pulse width measurement range	0.167 μ s to 178.956 s
Analog trigger	
Trigger source	All analog input channels, External analog trigger (EXTA_TRIG)
Trigger level	\pm Full scale for internal; \pm 10 V for external
Trigger conditions	Above high, below low, and window (software selectable)
Trigger level resolution	8 bits
Bandwidth	400 kHz
Input impedance for EXTA_TRIG	20 k Ω
Coupling	DC
Overvoltage protection	Continuous for \pm 35 V _{maximum}
Digital trigger	
Compatibility	TTL/CMOS
Response	Rising or falling edge
Pulse width	20 ns minimum
Calibration⁵	
On board reference	5 V
Temperature drift	\pm 2 ppm/ $^{\circ}$ C
Stability	\pm 6 ppm/1000 hrs
General	
Remote interface	Hi-Speed USB 2.0
Device class	USBTMC-USB488
Programmable interface	Standard Commands for Programmable Instruments (SCPI) and IVI-COM

¹ When multiple channels are used in the U2355A or U2356A, the sampling rate of each channel is the maximum sampling rate divided by the number of channels used. For multiple channels used in the U2331A, the sampling rate of each channel = (1 MSa/s) / number of channels used.

² System Synchronous Interface (SSI) and Star trigger commands are used when modular devices are used in the product chassis.

³ Maximum external reference voltage for analog output channels (AO_EXT_REF) is \pm 10 V.

⁴ Measurement frequency's resolution:

$$= 12 \text{ MHz}/n, n = 2, 3, 4, 5, \dots, 120 \text{ M}$$

$$= 6 \text{ MHz}, 4 \text{ MHz}, 3 \text{ MHz}, 2.4 \text{ MHz}, 2.0 \text{ MHz}, \dots, 0.1 \text{ Hz (up to six decimal points)}$$

⁵ 20 minutes warm-up time is recommended.

Electrical measurement specifications

Basic multifunction USB DAQ

Model number	U2351A, U2352A		U2353A, U2354A	
Analog input measurement ¹				
Function	23 °C ± 5 °C	0 °C to 18 °C 28 °C to 45 °C	23 °C ± 5 °C	0 °C to 18 °C 28 °C to 45 °C
Offset error	±1 mV	±5 mV	±1 mV	±5 mV
Gain error	±2 mV	±5 mV	±2 mV	±5 mV
-3 dB Small signal bandwidth ²	760 kHz		1.5 MHz	
1% THD Large signal bandwidth ²	300 kHz		300 kHz	
System noise	1 mVrms	2 mVrms	1 mVrms	2.5 mVrms
CMRR	62 dB		62 dB	
Spurious-Free Dynamic Range (SFDR) ³	88 dB		82 dB	
Signal-to-Noise and Distortion Ratio (SINAD) ³	80 dB		78 dB	
Total Harmonic Distortion (THD) ³	-90 dB		-82 dB	
Signal-to-Noise Ratio (SNR) ³	80 dB		78 dB	
Effective Number of Bits (ENOB) ³	13		12.6	

Model number	U2351A, U2353A	
Analog output measurement ¹		
Function	23 °C ± 5 °C	0 °C to 18 °C 28 °C to 45 °C
Offset error	±1 mV	±4 mV
Gain error	±4mV	±5 mV
Slew rate	19 V/μs	
Rise time	0.9 μs	
Fall time	0.9 μs	
Settling time to 1% output error	4 μs	
Driving capability	5 mA	
Glitch energy	5 ns-V (Typical), 80 ns-V (Maximum)	

¹ Specifications are for 20 minutes of warm-up time, calibration temperature at 23 °C and input range of ±10 V.

² Specifications are based on the following test condition:

Bandwidth test	Model number	Test conditions (DUT setting at ±10 V bipolar)	
-3 dB Small signal bandwidth 1% THD large signal bandwidth	U2351A U2352A	Sampling rate: Input voltage:	250 kSa/s
		- -3 dB Small signal bandwidth - 1% THD Large signal bandwidth	- 10% FSR - FSR -1 dB FS
	U2353A U2354A	Sampling rate: Input voltage:	500 kSa/s
		- -3 dB Small signal bandwidth - 1% THD Large signal bandwidth	- 10% FSR - FSR -1 dB FS

³ Specifications are based on the following test conditions:

Dynamic range test	Model number	Test conditions (DUT setting at ±10 V bipolar)	
SFDR, THD, SINAD, SNR, ENOB	U2351A U2352A	- Sampling rate: - Fundamental frequency: - Number of points: - Fundamental input voltage:	250 kSa/s 2.4109 kHz 8192 FSR -1 dB FS
	U2353A U2354A	- Sampling rate: - Fundamental frequency: - Number of points: - Fundamental input voltage:	500 kSa/s 4.974 kHz 16384 FSR -1 dB FS

High density multifunction USB DAQ

Model number	U2355A		U2356A		U2331A	
Analog input measurement ¹						
Function	23 °C ± 5 °C	0 °C to 18 °C 28 °C to 45 °C	23 °C ± 5 °C	0 °C to 18 °C 28 °C to 45 °C	23 °C ± 5 °C	0 °C to 18 °C 28 °C to 45 °C
Offset error	±1 mV	±2 mV	±1 mV	±2 mV	±2 mV	±3 mV
Gain error	±2 mV	±3 mV	±2 mV	±6 mV	±6 mV	±7.5 mV
-3 dB small signal bandwidth ²	760 kHz		1.3 MHz		1.2 MHz	
1% THD large signal bandwidth ²	400 kHz		400 kHz		N/A	
System noise	1 mVrms	2 mVrms	1 mVrms	4 mVrms	3 mVrms	5 mVrms
CMRR	64 dB		61 dB		62 dB	
Spurious-Free Dynamic Range (SFDR) ³	88 dB		86 dB		71 dB	
Signal-to-Noise and Distortion Ratio (SINAD) ³	80 dB		78 dB		72 dB	
Total Harmonic Distortion (THD) ³	-90 dB		-84 dB		-76 dB	
Signal-to-Noise Ratio (SNR) ³	80 dB		78 dB		72 dB	
Effective Number of Bits (ENOB) ³	13		12.6		11.6	

¹ Specifications are for 20 minutes of warm-up time, calibration temperature at 23 °C and input range of ±10 V.

² Specifications are based on the following test conditions.

Bandwidth test	Model number	Test conditions (DUT setting at ±10 V bipolar)
-3 dB Small signal bandwidth 1% THD Large signal bandwidth	U2355A	Sampling rate: 250 kSa/s Input voltage: - -3 dB Small signal bandwidth 10% FSR - 1% THD Large signal bandwidth FSR -1 dB FS
	U2356A	Sampling rate: 500 kSa/s Input voltage: - -3 dB Small signal bandwidth 10% FSR - 1% THD Large signal bandwidth FSR -1 dB FS
	U2331A	Sampling rate: 3 MSa/s Input voltage: - -3 dB Small signal bandwidth 10% FSR - 1% THD Large signal bandwidth FSR -1 dB FS

³ Specifications are based on the following test conditions.

Dynamic range test	Model number	Test conditions (DUT setting at ±10 V bipolar)
-3 dB Small signal bandwidth 1% THD Large signal bandwidth	U2355A	- Sampling rate: 250 kSa/s - Fundamental frequency: 2.4109 kHz - Number of points: 8192 - Fundamental input voltage: FSR -1 dB FS
	U2356A	- Sampling rate: 500 kSa/s - Fundamental frequency: 4.974 kHz - Number of points: 16384 - Fundamental input voltage: FSR -1 dB FS
	U2331A	- Sampling rate: 3 MSa/s - Fundamental frequency: 29.892 kHz - Number of points: 65536 - Fundamental input voltage: FSR -1 dB FS

High density multifunction USB DAQ (continued)

Model number	U2355A, U2356A		U2331A	
Analog output measurement ¹				
Function	23 °C ± 5 °C	0 °C to 18 °C 28 °C to 45 °C	23 °C ± 5 °C	0 °C to 18 °C 28 °C to 45 °C
Offset error	±1 mV	±4 mV	±1.5 mV	±3 mV
Gain error	±4 mV	±5 mV	±4 mV	±5 mV
Slew rate	19 V/μs		19 V/μs	
Rise time	0.9 μs		0.9 μs	
Fall time	0.9 μs		0.9 μs	
Settling time to 1% output error	4 μs		4 μs	
Driving capability	5 mA		5 mA	
Glitch energy	5 ns-V (Typical), 80 ns-V (Maximum)		5 ns-V (Typical), 80 ns-V (Maximum)	

¹ Specifications are for 20 minutes of warm-up time, calibration temperature at 23 °C and input range of ±10 V.

DC Characteristics

Accuracy Specifications

Model Number		U2351A, U2352A, U2353A, U2354A		
		Analog Input		
Unipolar Range (V)	Offset Error (mV) ¹	Gain Error (mV)	Accuracy (% of reading + offset error) ²	
10	1.5	2.0	0.04% + 1.5 mV	
5	1.5	2.0	0.08% + 1.5 mV	
2.5	1.0	1.0	0.08% + 1.0 mV	
1.25	1.0	1.0	0.16% + 1.0 mV	
Bipolar Range (V)	Offset Error (mV) ¹	Gain Error (mV)	Accuracy (% of reading + offset error) ²	
10	1.0	2.0	0.02% + 1.0 mV	
5	1.0	2.0	0.04% + 1.0 mV	
2.5	1.0	1.5	0.06% + 1.0 mV	
1.25	1.0	1.5	0.12% + 1.0 mV	

Model Number		U2355A, U2356A		
Unipolar Range (V)	Offset Error (mV) ¹	Gain Error (mV)	Accuracy (% of reading + offset error) ²	
10	1.0	1.5	0.03% + 1.0 mV	
5	1.0	1.5	0.06% + 1.0 mV	
2.5	1.0	1.0	0.08% + 1.0 mV	
1.25	1.0	1.0	0.16% + 1.0 mV	
Bipolar Range (V)	Offset Error (mV) ¹	Gain Error (mV)	Accuracy (% of reading + offset error) ²	
10	1.0	2.0	0.02% + 1.0 mV	
5	1.0	2.0	0.04% + 1.0 mV	
2.5	1.0	1.5	0.06% + 1.0 mV	
1.25	1.0	1.5	0.12% + 1.0 mV	

Model		U2331A		
Unipolar Range (V)	Offset Error (mV) ¹	Gain Error (mV)	Accuracy (% of reading + offset error) ²	
10	1.5	4.0	0.08% + 1.5 mV	
5	1.5	2.0	0.08% + 1.5 mV	
4	1.5	2.0	0.10% + 1.5 mV	
2.5	1.0	1.5	0.12% + 1.0 mV	
2	1.0	1.0	0.10% + 1.0 mV	
1	1.0	1.0	0.20% + 1.0 mV	
0.5	1.0	1.0	0.41% + 1.0 mV	
0.4	1.0	1.0	0.51% + 1.0 mV	
0.1	1.0	1.0	2.04% + 1.0 mV	

- The above specifications are typical for 23 °C.
- Specifications are for 20 minutes warm-up and self calibration.
- The measurement are calculated with 100 points averaging of data.

¹ Offset error is measured at midscale of full range.

² Accuracy = ± [% of |(Gain error / (Measured value – Midscale of FSR))| + Offset error]

Accuracy Specifications (Continued)

Model		U2331A		
Bipolar Range (V)	Offset Error (mV) ¹	Gain Error (mV)	Accuracy (% of reading + offset error) ²	
10	2.0	6.0	0.06% + 2.0 mV	
5	1.5	4.0	0.08% + 1.5 mV	
2.5	1.5	2.0	0.08% + 1.5 mV	
1.25	1.0	1.5	0.12% + 1.0 mV	
1	1.0	1.0	0.10% + 1.0 mV	
0.5	1.0	1.0	0.20% + 1.0 mV	
0.25	1.0	1.0	0.40% + 1.0 mV	
0.2	1.0	1.0	0.50% + 1.0 mV	
0.05	1.0	1.0	2.02% + 1.0 mV	

- The above specifications are typical for 23 °C.
- Specifications are for 20 minutes warm-up and self calibration.
- The measurement are calculated with 100 points averaging of data.

Model		U2351A, U2352A, U2353A, U2354A		
Unipolar Range (V)	Offset Error (mV) ³	Analog output		Accuracy (% of reading + offset error) ⁴
		Gain Error (mV)		
10	1.0	2.0		0.02% + 1.0 mV
Bipolar Range (V)	Offset Error (mV) ³	Gain Error (mV)	Accuracy (% of reading + offset error) ⁴	
10	1.0	4.0	0.04% + 1.0 mV	

Model		U2355A, U2356A		
Unipolar Range (V)	Offset Error (mV) ³	Gain Error (mV)	Accuracy (% of reading + offset error) ⁴	
10	1.0	2.0	0.02% + 1.0 mV	
Bipolar Range (V)	Offset Error (mV) ³	Gain Error (mV)	Accuracy (% of reading + offset error) ⁴	
10	1.0	4.0	0.04% + 1.0 mV	

Model		U2331A		
Unipolar Range (V)	Offset Error (mV) ³	Gain Error (mV)	Accuracy (% of reading + offset error) ⁴	
10	2.5	4.0	0.04% + 2.5 mV	
Bipolar Range (V)	Offset Error (mV) ³	Gain Error (mV)	Accuracy (% of reading + offset error) ⁴	
10	1.5	4.0	0.04% + 1.5 mV	

- The above specifications are typical for 23 °C.
- Specifications are for 20 minutes warm-up and self calibration.

¹ Offset error is measured at midscale of full range.

² Accuracy = ± [% of |(Gain error / (Measured value - Midscale of FSR))| + Offset error]

³ Offset error is measured at 0 V.

⁴ Accuracy = ± [% of |Gain error/Output value| + Offset voltage]

U2500A Series USB Modular Simultaneous Sampling Multifunction DAQ Devices

Features

- Simultaneous sampling with up to 2 MSa/s sampling rate for each channel
- Multifunction DAQ solution – AI, AO, DIO, counter
- Dedicated ADC per channel
- 14-bit or 16-bit resolution
- 24-bit programmable digital input/output
- Functions as a standalone or modular unit
- Supports SCPI and IVI-COM
- Compatible with a wide range of ADEs
- Easy-to-use bundled software
- Command logger function
- USB 2.0 and USBTMC-USB488 standards

Introduction

The Keysight U2500A Series USB simultaneous sampling multifunction data acquisition (DAQ) devices are high-performance modules that consist of three models – the U2531A, U2541A, and U2542A. The U2500A Series provides up to four channels with resolutions of 14-bit and 16-bit. The U2531A can sample up to 2 MSa/s for each channel with a resolution of 14 bits, while the U2541A and U2542A can sample up to 250 kSa/s and 500 kSa/s for each channel respectively with a resolution of 16 bits.

Various features of the U2500A Series

- Quick and easy USB setup
- High sampling rate of up to 2 MSa/s for each channel
- Dedicated analog-to-digital (ADC) that allows simultaneous sampling of data
- Flexible standalone or modular capability that enables lower startup cost
- SCPI and IVI-COM supported with a wide range of ADE compatibility that minimizes work time and increases software choices
- Easy-to-use application software and command logger function for easy SCPI command conversion into snippets of VEE, VB, C++, and C# code

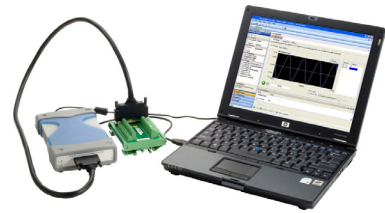

High sampling rate of up to 2 MSa/s

The U2500A Series provides a high analog input sampling rate coverage of up to 2 MSa/s for each channel. The high sampling rate coverage offered is ideal for transient signal applications such as sonar analysis.

Simultaneous sampling of data

The U2500A Series has dedicated ADCs that enable simultaneous signals acquisition, which makes the U2500A Series suitable for your phase-sensitive applications.

Product outlook and dimensions

Front view



Rear view



Top view

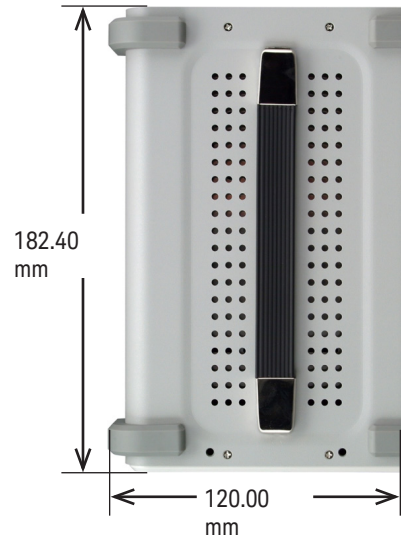

Standard shipped accessories

- AC/DC Power adapter
- Power cord
- USB extension cable
- L-Mount kit (used with modular product chassis)
- Keysight USB Modular Products Quick Start Guide
- Keysight Measurement Manager for U2500A Series Quick Start Guide
- Keysight USB Modular Products Reference CD-ROM
- Keysight Automation-Ready CD-ROM (contains the Keysight IO Libraries Suite)
- Certificate of Calibration

Optional accessories

- U2901A Terminal block and SCSI-II 68-pin connector with 1-meter cable
- U2902A Terminal block and SCSI-II 68-pin connector with 2-meter cable

Product characteristics and General Specifications

REMOTE INTERFACE

- Hi-Speed USB 2.0*
- USBTMC-USB488¹

POWER REQUIREMENT

- +12 VDC (TYPICAL)
- 2 A (MAX) input rated current
- Installation Category II

POWER CONSUMPTION

+12 VDC, 480 mA maximum

OPERATING ENVIRONMENT

- Operating temperature from 0 °C to +55 °C
- Relative humidity at 15% to 85% RH (non-condensing)
- Altitude up to 2000 meters
- Pollution Degree 2
- For indoor use only

STORAGE COMPLIANCE

-20 °C to 70 °C

SAFETY COMPLIANCE

Certified with:

- IEC 61010-1:2001/EN 61010-1:2001 (2nd Edition)
- USA: ANSI/UL 61010-1:2004
- Canada: CSA C22.2 No.61010-1:2004

EMC COMPLIANCE

- IEC 61326-1:2002/EN 61326-1:1997+A2:2001+A3:2003
- CISPR 11: 1990/EN 55011:1990-Group 1 Class A
- Canada: ICES-001:2004
- Australia/New Zealand: AS/NZS CISPR 11:2004

SHOCK AND VIBRATION

Tested to IEC/EN 60068-2

IO CONNECTOR

68-pin female VHDCI Type

DIMENSION (W × D × H)

Module dimension:

- 120.00 mm × 182.40 mm × 44.00 mm (with plastic casing)
- 105.00 mm × 174.54 mm × 25.00 mm (without plastic casing)

Terminal block dimension:

- 103.00 mm × 85.20 mm × 42.96 mm

WEIGHT

- 565 g (with plastic casing)
- 400 g (without plastic casing)

¹ Compatible with Microsoft Windows operating systems only.

*If remote connections are necessary, a E5813A USB/LAN hub can be used. Please go to the product's user guide for more information.

Product specifications

Model number	U2531A	U2541A	U2542A
Analog input			
Resolution	14 bits		16 bits
Number of channels	4 differential input channels (software selectable/channel)		
Maximum sampling rate	2 MSa/s	250 kSa/s	500 kSa/s
Programmable bipolar input range ¹	±10 V, ±5 V, ±2.5 V, ±1.25 V		
Programmable unipolar input range	0 to 10 V, 0 to 5 V, 0 to 2.5 V, 0 to 1.25 V		
Input coupling	DC		
Input impedance	1 GΩ/100 pF		
Operational common mode voltage range	±8.0 V maximum		
Overvoltage range	Power-on: Continuous ±30 V, Power-off: Continuous ±15 V		
Trigger sources	External analog/digital trigger, SSI/star trigger ²		
Trigger modes	Pre-trigger, delay-trigger, post-trigger, and middle-trigger		
FIFO buffer size	Up to 8 MSa		
Analog output			
Resolution	12 Bits		
Number of channels	2		
Maximum update rate	1 MSa/s		
Output ranges	0 to 10 V, ±10 V, 0 to AO_EXT_REF, ±AO_EXT_REF ³		
Output coupling	DC		
Output impedance	0.1 Ω Typical		
Stability	Any passive load up to 1500 pF		
Power-on state	0 V steady state		
Trigger sources	External analog/digital trigger, SSI/star trigger ²		
Trigger modes	Delay trigger, post trigger		
FIFO buffer size	1 Channel used: Maximum 8 MSa 4 Channels used: Maximum 2 MSa/ch		
Glitch energy	5 ns-V (Typical), 80 ns-V (Maximum)		
Driving capability	5 mA		
Function generation mode	Sine, square, triangle, sawtooth, and noise waveforms		
Digital input/output			
Number of bits	24-bit programmable input/output		
Compatibility	TTL		
Input voltage	VIL = 0.7 V maximum; IIL = 10 μA maximum VIH = 2.0 V minimum; IIH = 10 μA maximum		
Input voltage range	-0.5 V to +5.5 V		
Output voltage	VOL = 0.45 V maximum; IOL = 8 mA maximum VOH = 2.4 V minimum; IOH = 400 μA maximum		
General purpose digital timer/counter			
Maximum count	(231 - 1) bits		
Number of channels	2 Independent up/down counter		
Compatibility	TTL		
Clock source	Internal or external		
Base clock available	48 MHz		
Maximum clock source frequency	12 MHz		
Input frequency range ⁴	0.1 Hz to 6 MHz at 50% duty cycle		
Pulse width measurement range	0.167 μs to 178.956 s ±0.0833 μs		

Product specifications (continued)

Model number	U2531A	U2541A	U2542A
Analog trigger			
Trigger source	All analog input channels, External analog trigger (EXTA_TRIG)		
Trigger level	±Full scale for internal ±10 V for external		
Trigger conditions	Above high, below low, and window (software selectable)		
Trigger level resolution	8 bits		
Bandwidth	400 kHz		
Input impedance for EXTA_TRIG	20 kΩ		
Coupling	DC		
Overvoltage protection	Continuous for ±35 V maximum		
Digital trigger			
Compatibility	TTL/CMOS		
Response	Rising or falling edge		
Pulse width	20 ns minimum		
Calibration⁵			
On board reference voltage	5 V		
Temperature drift	±2 ppm/°C		
Stability	±6 ppm/1000 hours		
Power consumption			
Input voltage (DC)	+12 VDC		
Input current	480 mA maximum	390 mA maximum	
Physical attributes			
Dimensions (W × D × H)	120.00 mm × 182.40 mm × 44 mm (with plastic casing) 105.00 mm × 174.54 mm × 25.00 mm (without plastic casing)		
IO connector	68-pin female VHDCI type		
Weight	565 g with plastic casing 400 g without plastic casing		
Environmental condition			
Operating temperature	0 to 55 °C		
Storage temperature	-20 °C to 70 °C		
Relative humidity	15% to 85% RH (non-condensing)		
General			
Remote interface	Hi-Speed USB 2.0		
Device class	USBTMC-USB488		
Programmable interface	SCPI and IVI-COM		

¹ Maximum input voltage for analog input is ±10 V.

² System Synchronous Interface (SSI) and star trigger commands are applicable when modular devices are used in modular product chassis (U2781A).

³ Maximum external reference voltage for analog output (AO_EXT_REF) is ±10 V.

⁴ Measurement frequency's resolution:
= 12 MHz/n, n = 2, 3, 4, 5, ..., 120 M
= 6 MHz, 4 MHz, 3 MHz, 2.4 MHz, 2.0 MHz, ..., 0.1 Hz (up to six decimal points)

⁵ Recommended for 20 minutes warm-up time.

Electrical specifications and characteristics

Analog input characteristics¹

Model number	U2531A		U2541A		U2542A	
	23 °C ± 5 °C	0 °C to 18 °C 28 °C to 55 °C	23 °C ± 5 °C	0 °C to 18 °C 28 °C to 55 °C	23 °C ± 5 °C	0 °C to 18 °C 28 °C to 55 °C
Offset error ²	±2 mV	±2 mV	±1 mV	±1 mV	±1 mV	±1 mV
Gain error ²	±6 mV	±6 mV	±2 mV	±2.5 mV	±2 mV	±2.5 mV
-3 dB Small signal bandwidth	1.2 MHz		600 KHz		1.0 MHz	
1% THD Large signal bandwidth	400 KHz		400 KHz		400 KHz	
System noise ³	2.0 mVrms		0.5 mVrms		0.5 mVrms	
CMRR (DC to 60 Hz)	64 dB		80 dB		80 dB	
Spurious-Free Dynamic Range (SFDR)	76 dB		88 dB		86 dB	
Signal-to-Noise and Distortion Ratio (SINAD)	70 dB		82 dB		80 dB	
Total Harmonic Distortion (THD)	-72 dB		-86 dB		-84 dB	
Signal-to-Noise Ratio (SNR)	72 dB		84 dB		82 dB	
Effective Number of Bits (ENOB)	11.3-bit		13.3-bit		13.0-bit	
Channels crosstalk ⁴	66 dB		84 dB		80 dB	

Analog output characteristics¹

Model number	U2531A		U2541A		U2542A	
	23 °C ± 5 °C	0 °C to 18 °C 28 °C to 55 °C	23 °C ± 5 °C	0 °C to 18 °C 28 °C to 55 °C	23 °C ± 5 °C	0 °C to 18 °C 28 °C to 55 °C
Offset error	±1 mV	±3 mV	±1 mV	±3 mV	±1 mV	±3 mV
Gain error	±3 mV	±4 mV	±2 mV	±4 mV	±2 mV	±4 mV
Slew rate	15 V/μs		15 V/μs		15 V/μs	
Rise time	1.1 μs	1.2 μs	1.1 μs	1.2 μs	1.1 μs	1.2 μs
Fall time	1.1 μs	1.2 μs	1.1 μs	1.2 μs	1.1 μs	1.2 μs
Settling time(s) to 1% output error	2 μs		2 μs		2 μs	

¹ Specifications are based on 20 minutes warm-up, self-calibration temperature at 23 °C, and bipolar input range of ±10 V.

² The measurements are calculated with 100 points averaging of data.

³ The noise rms value is the standard deviation of 20000 points.

⁴ The crosstalk measurements are tested up to input frequency of $F_{in} = \text{MaxSamplingRate}/2$.

Test condition

Dynamic range test for U2500A Series DAQ devices

Dynamic range test	Model	Test conditions (DUT setting at ± 10 V bipolar)
SFDR, THD, SINAD, SNR, ENOB	U2531A	<ul style="list-style-type: none"> - Sampling rate: 2 MSa/s - Fundamental frequency: 19.927 kHz - Number of points: 65536 - Fundamental input voltage: FSR -1 dB FS
	U2541A	<ul style="list-style-type: none"> - Sampling rate: 250 kSa/s - Fundamental frequency: 2.4109 kHz - Number of points: 8192 - Fundamental input voltage: FSR - 1 dBFS
	U2542A	<ul style="list-style-type: none"> - Sampling rate: 500 kSa/s - Fundamental frequency: 4.974 kHz - Number of points: 16384 - Fundamental input voltage: FSR - 1 dBFS

Bandwidth test for U2500A Series DAQ devices

Bandwidth test	Model	Test conditions (DUT setting at ± 10 V bipolar)
-3 dB Small signal bandwidth: 1% THD Large signal bandwidth:	U2531A	<ul style="list-style-type: none"> - Sampling rate: 2 MSa/s - Input voltage - -3 dB Small signal bandwidth: 10% FSR - 1% THD Large signal bandwidth: FSR - 1 dBFS
	U2541A	<ul style="list-style-type: none"> - Sampling rate: 250 kSa/s - Input voltage - -3 dB Small signal bandwidth: 10% FSR - 1% THD Large signal bandwidth: FSR - 1 dBFS
	U2542A	<ul style="list-style-type: none"> - Sampling rate: 500 kSa/s - Input voltage - -3 dB Small signal bandwidth: 10% FSR - 1% THD Large signal bandwidth: FSR - 1 dBFS

Typical performance graph

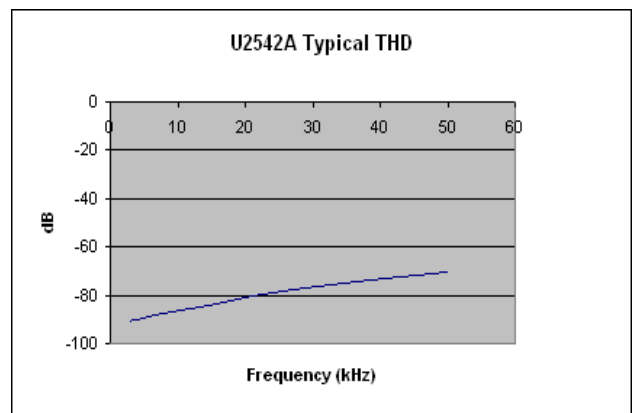
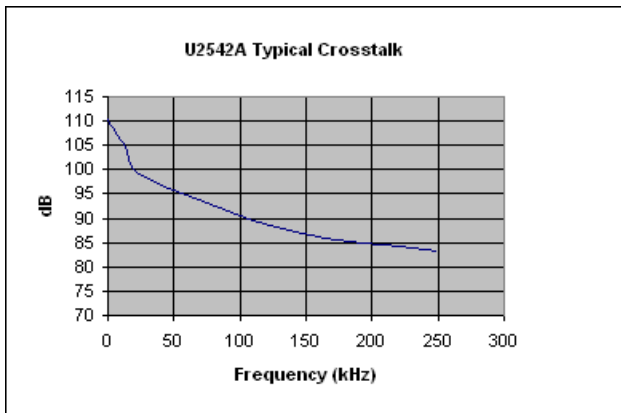
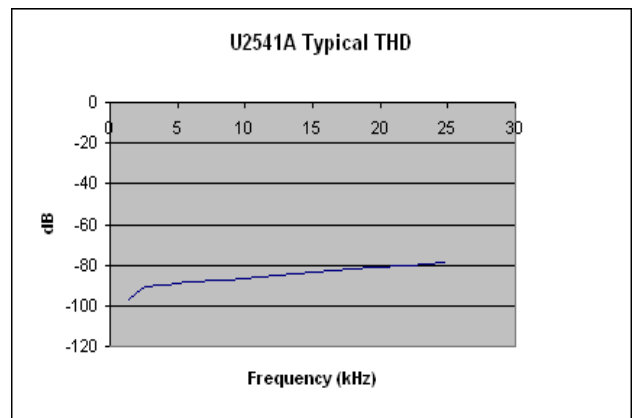
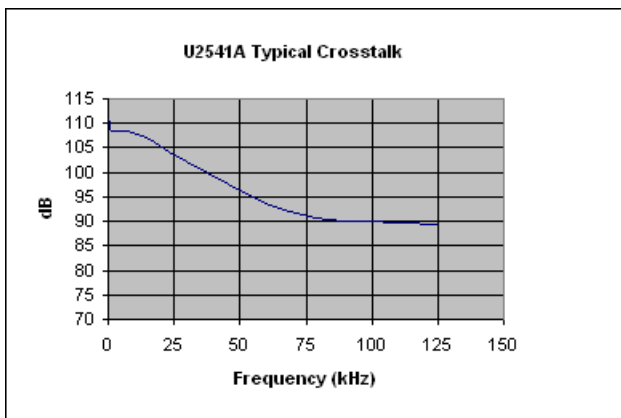
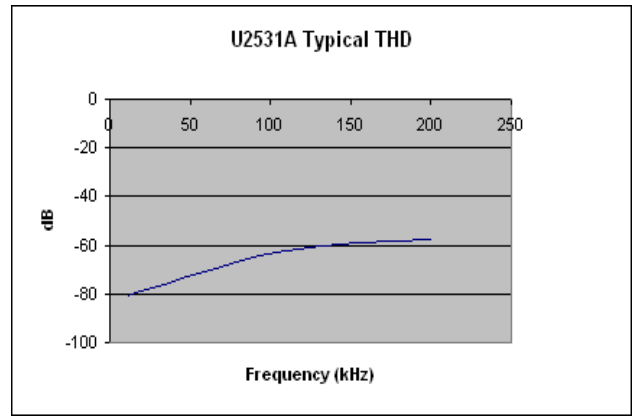
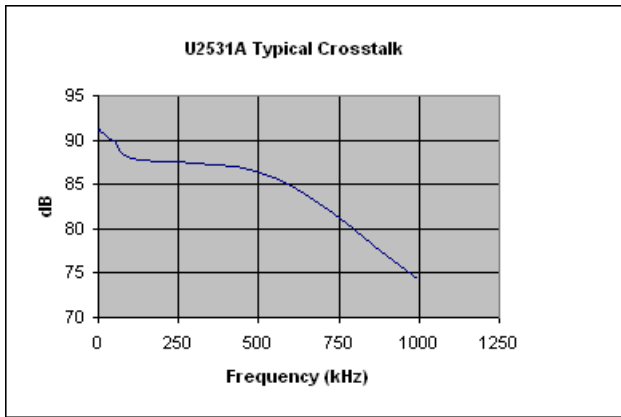

DC characteristics

Accuracy specifications¹

Model		U2541A, U2542A		
		Analog input		
Unipolar range (V)	Offset error (mV) ²	Gain error (mV)	Accuracy (% of reading + offset error) ³	
10	1.0	1.0	0.02% + 1.0 mV	
5	1.0	1.0	0.04% + 1.0 mV	
2.5	1.0	1.0	0.08% + 1.0 mV	
1.25	1.0	1.0	0.16% + 1.0 mV	
Bipolar range (V)				
10	1.0	2.0	0.02% + 1.0 mV	
5	1.0	1.0	0.02% + 1.0 mV	
2.5	1.0	1.0	0.04% + 1.0 mV	
1.25	1.0	1.0	0.08% + 1.0 mV	
Model		U2531A		
Unipolar range (V)	Offset error (mV) ²	Gain error (mV)	Accuracy (% of reading + offset error) ³	
10	2.0	3.0	0.06% + 2.0 mV	
5	1.5	1.5	0.06% + 1.5 mV	
2.5	1.0	1.0	0.08% + 1.0 mV	
1.25	1.0	1.0	0.16% + 1.0 mV	
Bipolar range (V)				
10	2.0	6.0	0.06% + 2.0 mV	
5	1.5	3.0	0.06% + 1.5 mV	
2.5	1.0	2.0	0.08% + 1.0 mV	
1.25	1.0	1.0	0.08% + 1.0 mV	
Model		U2541A, U2542A		
		Analog output		
Unipolar range (V)	Offset error (mV) ²	Gain error (mV)	Accuracy (% of reading + offset error) ⁴	
10	1.0	2.0	0.02% + 1.0 mV	
Bipolar range (V)				
10	1.0	2.0	0.02% + 1.0 mV	
Model		U2531A		
Unipolar range (V)	Offset error (mV) ²	Gain error (mV)	Accuracy (% of reading + offset error) ⁴	
10	1.0	3.0	0.03% + 1.0 mV	
Bipolar range (V)				
10	1.0	3.0	0.03% + 1.0 mV	

¹ Specifications are based on 20 minutes warm-up, and self-calibration temperature at 23 °C.

² Offset error is measured at 0 V.

³ Accuracy = ± [% of Gain error / (Measured value - Midscale) + Offset error]

⁴ Accuracy = ± (% of Gain error / Output value + Offset error)

U2600A Series USB Modular Isolated Digital I/O Devices

Features

- Hi-Speed USB 2.0 (480 Mbps)
Functions as standalone or modular unit
- Up to 64 opto-isolated digital I/O lines with maximum transient voltage of 1250 V_{peak} protection
- Supports input voltage ranging from 10 V to 24 V
- External supply voltage ranging from 5 V to 35 V for external load
- Compatible with a wide range of ADEs
- Supports SCPI and IVI-COM
- Easy-to-use bundled software
- Command logger function
- USB 2.0 and USBTMC-USB488 standards
- Interrupt function
- Virtual Port grouping function

Introduction

The Keysight U2600A Series USB isolated digital I/O devices are high-performance modules that consist of three models– the U2651A isolated 32-bit DI and 32-bit DO, U2652A isolated 64-bit DI, and U2653A isolated 64-bit DO. The U2600A Series provides up to eight channels with 64-bit of high-density opto-isolated digital input and digital output for USB 2.0 interface-based industrial applications, such as driving relays, actuators, or valve. The U2600A Series targets a wide range of applications both in industrial automation and education.

Various features to meet industrial demands

- Quick and easy USB setup
- High channel count to drive more actuators and control more sensors by using just one DIO device
- Opto-isolation for more reliable and improved signal quality
- High isolated transient voltage protection of the digital IO lines is able to protect your system from being damaged
- Wide input voltage range of 10 V to 24 V to sense the status of external sensors
- High output voltage range of 5 V to 35 V provides the capability to drive a wide array of actuators in industrial automation applications
- On-board isolated +5 V power supply enables simple application and function tests without the need for an external source
- SCPI and IVI-COM supports and compatibility with a wide range of ADEs minimize work time and provides a higher flexibility of software choices
- Command logger function provided in the bundled software allows easy command conversion into snippets of VEE, VB, C++, and C# code
- Interrupt function for automatic triggering of your system when a digital change of state occurs
- Virtual Port grouping function allows grouping of any eight input/output bits into one virtual port for simultaneous operations



High channel count with opto-isolated digital input and digital output

The U2600A Series has high channel count with up to 64-bit high-density opto-isolated digital input and digital output that increases its usability. With just one DIO device, you are able to drive more actuators and control more sensors. Furthermore, opto-isolation separates the electrical connection between circuits for better PC system protection. Thus, making the U2600A Series more reliable with its opto-isolated digital input and digital output.

High isolated transient voltage protection

Isolation prevents any potential harmful current that may be induced by transient voltage spikes from flowing through the digital IO lines to the system. The robust 1250 Vpeak transient isolation protection allows the U2600A Series to have direct connection to a wide range of industrial sensors and actuators, making the U2600A suitable for most industrial applications.

High I/O voltage range

The U2600A Series has a high input/output voltage range that is suitable for demanding industrial applications such as driving relays and actuators, which require up to 24 V. The U2600A Series has a wide input range of 10 V to 24 V to sense the status of external sensors. It also has an external supply voltage that is ranging from 5 V to 35 V, which enables the U2600A Series to drive a wide range of actuators.



Interrupt function

The U2600A Series has an interrupt function that automatically triggers your system when a digital change of state occurs. Unlike polling, this function minimizes the overheads of your PC system especially when the U2600A Series is used in multitasking applications.

Virtual Port grouping function

The Virtual Port grouping function allows users to randomly select any eight input or output bits and group them into one channel as a virtual DIO port.

The following describes the key advantages of using the Virtual Port grouping function:

- You can control multiple bits simultaneously for the instantaneous control of multiple machines, such as emergency stop control.
- You can make changes to your port assignments whenever required as the Virtual Port is easily programmable.
- It eliminates the need for you to rewire your hardware devices to different bits for different applications. This makes the U2600A Series suitable for research and development applications, which require on-going testing that involves many hardware setup changes.

Product outlook and dimensions

Front view



Rear view



Top view

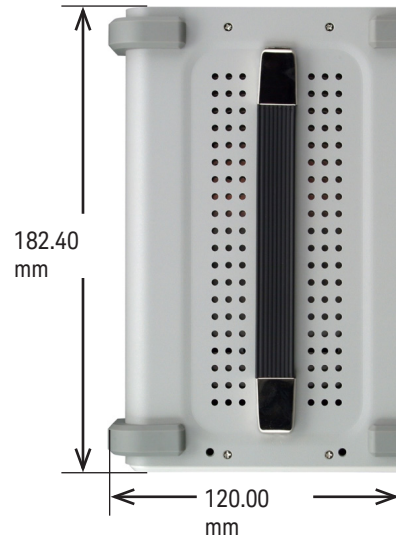

Standard shipped accessories

- AC/DC Power adapter
- Power cord
- USB extension cable
- L-Mount kit (used with modular product chassis)
- Keysight USB Modular Products Quick Start Guide
- Keysight Measurement Manager for U2600A Series Quick Start Guide
- Keysight USB Modular Products Reference CD-ROM
- Keysight Automation-Ready CD-ROM (contains the Keysight IO Libraries Suite)
- Certificate of Calibration

Optional accessories

- U2903A Terminal block and SCSI-II 100-pin connector with 1-meter cable
- U2904A Terminal block and SCSI-II 100-pin connector with 2-meter cable

Product characteristics and general specifications

REMOTE INTERFACE

- Hi-Speed USB 2.0*
- USBTMC-USB488¹

POWER REQUIREMENT

- +12 VDC (TYPICAL)
- 2 A (MAX) input rated current
- Installation Category II

POWER CONSUMPTION

+12 VDC, 260 mA maximum

OPERATING ENVIRONMENT

- Operating temperature from 0 °C to +55 °C
- Relative humidity at 15% to 85% at 40 °C (non-condensing)
- Altitude up to 2000 meters
- Pollution Degree 2
- For indoor use only

STORAGE COMPLIANCE

-20 °C to 70 °C

SAFETY COMPLIANCE

Certified with:

- IEC 61010-1:2001/EN 61010-1:2001 (2nd Edition)
- USA: ANSI/UL 61010-1:2004
- Canada: CSA C22.2 No.61010-1:2004

EMC COMPLIANCE

- IEC 61326-1:2002/EN 61326-1:1997+A2:2001+A3:2003
- CISPR 11: 1990/EN 55011:1990-Group 1 Class A
- Canada: ICES-001:2004
- Australia/New Zealand: AS/NZS CISPR 11:2004

SHOCK AND VIBRATION

Tested to IEC/EN 60068-2

IO CONNECTOR

100-pin SCSI-II connector

DIMENSION (W × D × H)

Module dimension:

- 120.00 mm × 182.40 mm × 44.00 mm (with plastic casing)
- 105.00 mm × 174.54 mm × 25.00 mm (without plastic casing)

Terminal block dimension:

- 158.00 mm × 118.60 mm × 51.50 mm

WEIGHT

- 565 g (with plastic casing)
- 370 g (without plastic casing)

¹ Compatible with Microsoft Windows operating systems only.

*If remote connections are necessary, a E5813A USB/LAN hub can be used. Please go to the product's user guide for more information.

Product specifications

Model number	U2651A	U2652A	U2653A
Digital input			
Number of isolated bits	32-bit	64-bit	-
Input type	Opto-isolated	Opto-isolated	-
Maximum input voltage range ¹	24 V, non-polarity	24 V, non-polarity	-
Digital logic levels ²	High: 10 V to 24 V Low: 0 V to 2 V	High: 10 V to 24 V Low: 0 V to 2 V	-
Input resistance	24 kΩ at 0.75 W	24 kΩ at 0.75 W	-
Input current (maximum)	1.5 mA per bit	1.5 mA per bit	-
Maximum transient voltage ³	1250 V _{peak}	1250 V _{peak}	-
Interrupt sources	DI_101.0/301 and DI_101.1/302	DI_101.0/301 and DI_101.1/302	-
Digital output			
Number of isolated bits	32-bit	-	64-bit
Output type	Open drain power MOSFET driver	-	Open drain power MOSFET driver
External supply voltage range	5 V to 35 V	-	5 V to 35 V
Voltage drop at MOSFET when on	V _{Drop} < 1.0 V (Maximum)	-	V _{Drop} < 1.0 V (Maximum)
Output sink current per bit	500 mA (100% duty cycle) per bit 400 mA (100% duty cycle) when full 32-bit loaded	-	500 mA (100% duty cycle) per bit 400 mA (100% duty cycle) when full 32-bit loaded
Maximum transient voltage	1250 V _{peak}	-	1250 V _{peak}
On board isolated +5 V power supply			
Output voltage (Typical)	+5 V	-	+5 V
Output current (Typical)	150 mA	-	150 mA
Maximum power	0.85 W	-	0.85 W
General			
Power consumption	+12 V at 235 mA (Typical)	+12 V at 115 mA (Typical)	+12 V at 260 mA (Typical)
Relative humidity	Operating: 15% to 85% at 40 °C (non-condensing) Non-operating: 90% RH at 65 °C for 24 hours		
Storage temperature	-20 °C to +70 °C		
Operating temperature	0 °C to +55 °C		
Connector type	100-pin SCSI-II connector		
Dimensions (W × D × H)	120.00 mm × 182.40 mm × 44.00 mm (with plastic casing) 105.00 mm × 174.54 mm × 25.00 mm (without plastic casing)		
Remote interface	Hi-Speed USB 2.0		

¹ Maximum input voltage is 24 V with reference to DI_{COM}.

² Voltage level with reference to DI_{COM}.

³ Maximum transient voltage between DI_{in} and DI_{COM}.

U2802A 31-Channel Thermocouple Input Device

Features

- Up to 31 thermocouple inputs
- Supports thermocouple type J, K, R, S, T, N, E, and B
- Up to 10 V voltage input range
- Open thermocouple detection
- Built-in isothermal terminal construction
- Built-in thermistor
- Built-in zeroing function
- Sampling rate of 500 kSa/s for overall module
- Sampling rate of 10 kSa/s total for all channels in thermocouple mode
- Configurable for voltage input or thermocouple input mode independently on each channel

Introduction

The Keysight U2802A is a 31-channel thermocouple signal conditioning module with a built-in thermistor for cold junction compensation. The U2802A is designed to convert low input voltage signals (less than ± 100 mV) from a thermocouple into an output voltage range suitable for data acquisition devices (± 10 V). The U2802A device is to be used in conjunction with the Keysight U2355A or U2356A model DAQ device to enable temperature measurements using thermocouples. It works as a standalone device attached to a single DAQ device via two SCSI-II 68 conductor cables. The U2802A is compatible with eight standard thermocouple types and is suitable for a wide range of applications in various industrial environment.

Features to meet your demands

- 31 input channels that can be independently configured to either differential thermocouple input mode, single-ended voltage input mode, or differential voltage input mode using two input channels set to voltage input mode
- Supports the standard thermocouple types defined in the NIST ITS-90 Thermocouple Database
- Error detection for open thermocouple channels
- Built-in isothermal construction on terminal block for improved measurement accuracy
- Built-in zeroing function to compensate for overall system offset errors due to temperature drift and long term drift
- Up to ± 10 V input voltage range for higher voltage inputs
- Quick and easy USB setup
- Robust, cost-effective, and user friendly



Applications

The U2802A thermocouple input device is designed for robust and demanding industrial applications. This product is suitable and ideal for thermocouple measurement applications such as,

- product thermal analysis and characterization,
- environmental chamber profiling,
- process monitoring in consumer electronics markets,
- material properties testing in education environments,
- study of electronic temperature properties, and
- appliances testing.

Thermocouple input mode

In thermocouple input mode, the U2802A can acquire up to ± 100 mV input signals. Each channel includes an instrumentation amplifier and a 4 Hz low-pass filter. The low-pass filter removes unwanted noise from the thermocouple wires to obtain accurate measurement data.

Voltage input mode

Alternatively, you can select separate voltage input modes for each channel. The channel will be set to bypass the amplifier and filter, allowing up to ± 10 V input signals to be directly routed to the DAQ device analog input. The bandwidth in this mode is more than 500 kHz.

Zero mode

In zero mode, the positive and negative inputs of the instrumentation amplifier are shorted together. The voltage measured in this mode corresponds to the offset voltage of the channel. You can subtract this offset voltage from subsequent thermocouple mode measurements to increase measurement accuracy. This mode is only applicable in thermocouple mode.

Thermocouple compatibility

The U2802A is compatible with a wide range of standard thermocouple types defined in the NIST ITS-90 Thermocouple Database. This includes types J, K, R, S, T, N, E, and B.

Open thermocouple detection

The U2802A includes open thermocouple detection circuitry to indicate the presence of an open thermocouple.

Calibration EEPROM

The U2802A gain and offset calibration factors for each channel are stored in the EEPROM during factory calibration and can be retrieved prior to taking measurements. This on-board EEPROM also stores the module ID, serial number, and date of calibration for your reference. A section of the EEPROM is also allocated for you to save your calibration data.

Restoring factory calibration

Using the KMM software, you can easily restore the U2802A calibration data from your settings to the original factory settings.



Product outlook and dimensions

Front view



Rear view



Top and side view

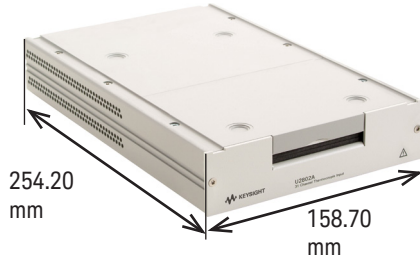

Standard shipped accessories

- Power supply splitter
- Two 68-pin SCSI cables (1 m)
- One J-type thermocouple
- Keysight U2802A 31-Channel Thermocouple Input Device Quick Start Guide
- Keysight USB Modular Products Reference CD-ROM
- Keysight Automation-Ready CD-ROM (contains the Keysight IO Libraries Suite)
- Certificate of Calibration

Product characteristics and general specifications

POWER CONSUMPTION

+12 VDC, 480 mA maximum

OPERATING ENVIRONMENT

- Operating temperature from 0 °C to +55 °C
 - Relative humidity at 50% to 85% RH (non-condensing)
 - Altitude up to 2000 meters
-

STORAGE COMPLIANCE

-40 °C to 70 °C

SAFETY COMPLIANCE

Certified with:

- IEC 61010-1:2001/EN 61010-1:2001 (2nd Edition)
-

EMC COMPLIANCE

- IEC 61326-1:2002/EN 61326-1:1997+A2:2001+A3:2003
 - CISPR 11: 1990/EN 55011:1990-Group 1 Class A
 - Canada: ICES-001:2004
 - Australia/New Zealand: AS/NZS CISPR 11:2004
-

SHOCK AND VIBRATION

Tested to IEC/EN 60068-2

IO CONNECTOR

- 2 × 68-pin female SCSI connector
 - 2 × 34 pin screw terminal block
 - 1 × 24 pin screw terminal block
-

DIMENSION (W × D × H)

158.70 mm × 254.20 mm × 40.50 mm

WEIGHT

1.036 kg

Product specifications

General characteristics	
Number of channels	31 differential and 1 CJC
Input voltage range for voltage mode	± 10 V (signal + common mode)
Input voltage (thermocouple mode)	± 100 mV
Sampling rate for thermocouple mode	10 kSa/s total for all channels
Sampling rate for overall module	500 kSa/s
Thermocouple types	J, K, R, S, T, N, E, and B
Input specifications	
Accuracy (thermocouple mode)	
– Overall gain error	0.06% ($23\text{ }^{\circ}\text{C} \pm 5\text{ }^{\circ}\text{C}$)
– Overall offset error	15 μV (without zeroing) ($23\text{ }^{\circ}\text{C} \pm 5\text{ }^{\circ}\text{C}$) 6 μV (with zeroing)
– Nonlinearity	< 0.005% of full scale range
System noise (rms)	
– Gain ($\times 1$)	100 μVrms
– Gain ($\times 100$)	5 μVrms
Common Mode Rejection Ratio (CMRR)	
– Voltage mode	> 60 dB
– Thermocouple mode	> 80 dB
Cold junction accuracy	$\pm 1.0\text{ }^{\circ}\text{C}$ typical ($23\text{ }^{\circ}\text{C} \pm 5\text{ }^{\circ}\text{C}$) $\pm 1.5\text{ }^{\circ}\text{C}$ typical ($0\text{ }^{\circ}\text{C}$ to $18\text{ }^{\circ}\text{C}$, $28\text{ }^{\circ}\text{C}$ to $55\text{ }^{\circ}\text{C}$)
Input characteristics	
Bandwidth (voltage mode)	> 500 kHz
Bandwidth (thermocouple mode)	4.0 Hz
Overvoltage protection ¹	TC Mode² Common mode: ± 17 V (TC+ and TC– with respect to GND) Differential mode: ± 7 V (Differential voltage between TC+ and TC–) Bypass mode ± 20 V (TC+ input with respect to GND) Power-off Mode ± 11 V (TC+, TC– input with respect to GND)
Input impedance	> 1 G Ω
Input bias current	± 2.5 nA max
Input offset current	± 1.5 nA max
Gain drift	60 ppm/ $^{\circ}\text{C}$ max
Offset drift	1 $\mu\text{V}/^{\circ}\text{C}$ max
Filter cutoff frequency (–3 dB) (thermocouple mode)	4.0 Hz
Filter type (thermocouple mode)	Low Pass RC Filter
Other features	
Recommended warm up time	30 minutes

¹ The overvoltage protection levels specified above indicate the maximum voltage each input pin can tolerate without resulting in any damages. However, prolonged exposure to these levels may affect device safety and reliability. Hence, it should be avoided where possible.

² On the channels configured for thermocouple mode, the TC+ and TC– pins can tolerate up to ± 17 V of differential voltage for a few minutes. However, exceeding a voltage range of ± 100 mV on these channels can cause additional current to be drawn from the device's power supply regulators, which may damage the device if multiple channels are overdriven for prolonged periods. This is the case when a voltage source is tied across the TC_n+ and TC_n– pin. Voltage sources greater than ± 100 mV should be tied to TC_n+ and GND (floating source), or TC_n+ and TC_{n+1}+ (grounded source), and have the channels set for bypass mode.

Thermocouples typical measurement accuracy

The U2802A measurement error with U2355A or U2356A at $23\text{ }^{\circ}\text{C} \pm 5\text{ }^{\circ}\text{C}$ is shown below.

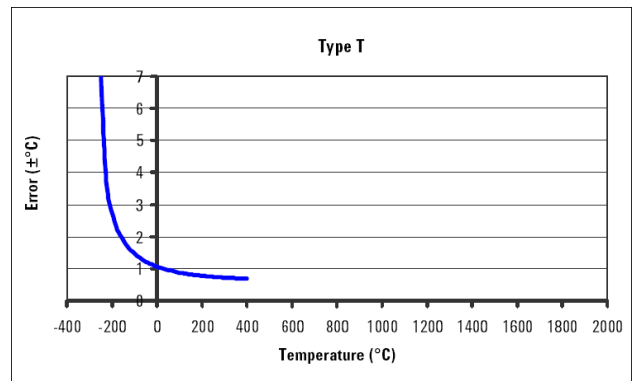
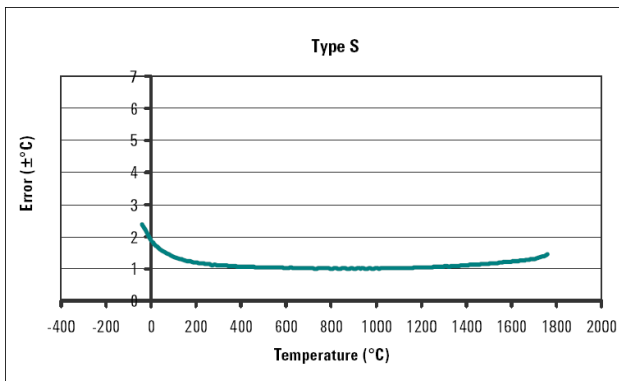
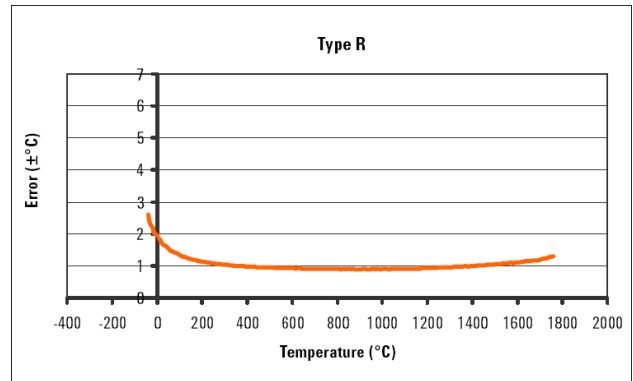
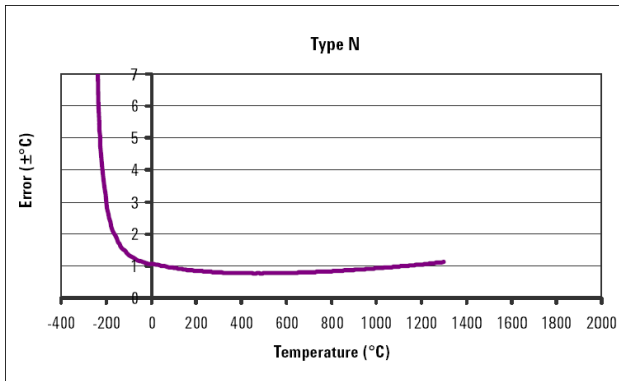
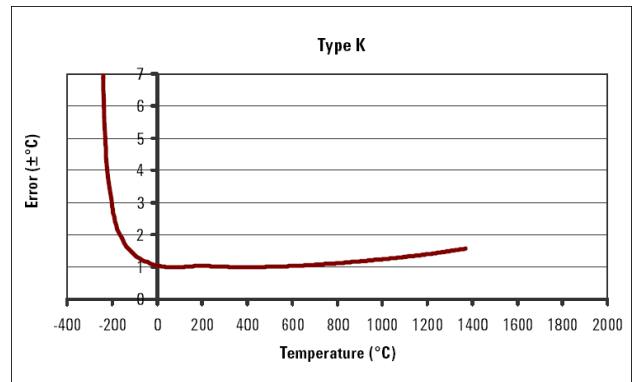
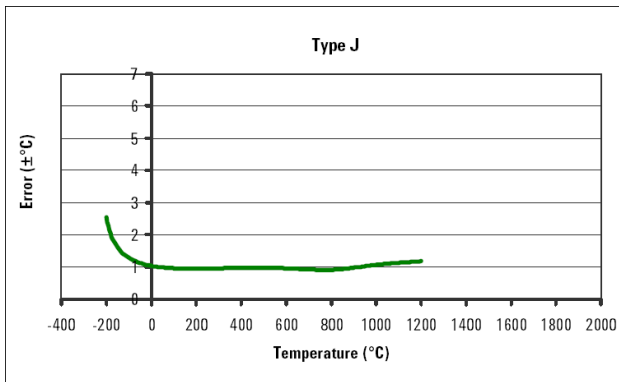
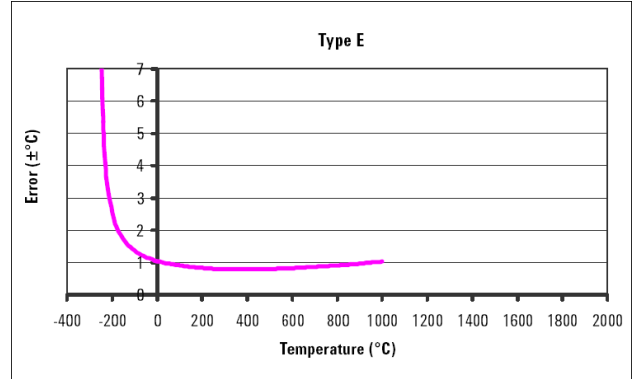
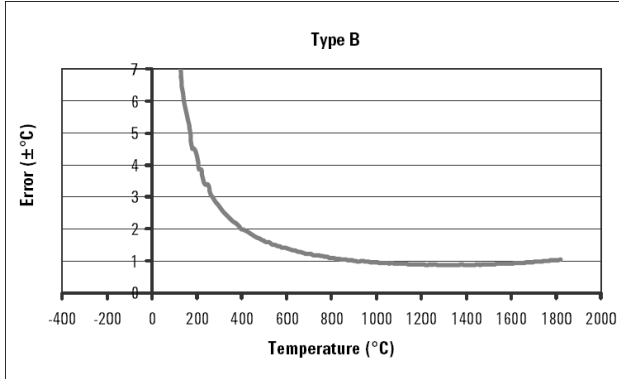

System accuracy specifications

The U2802A system accuracy specifications are shown in Table 1, Table 2, and Table 3. These measurements are derived from the U2802A and DAQ input accuracy specifications without including the thermocouple error. Refer to “Calculating System Accuracy” section in the *Keysight U2802A 31-Channel Thermocouple Input Device User’s Guide* for calculation methodology.

Table 1. Measurement accuracy of the U2355A and U2356A at 23 °C ± 5 °C

Thermocouple measurement accuracy (U2355A, U2356A @ 23 °C ± 5 °C)							
T/C type	ITS-90 Temperature range (°C)		Optimum measurement range (°C)		Without averaging (± °C)	50 points averaging (± °C)	500 points averaging (± °C)
	Low	High	Low	High			
B	0	1820	1100	1820	1.9	1.2	1.0
			400	1100	4.4	2.5	2.0
E	-270	1000	-150	1000	1.7	1.6	1.6
			-200	-150	2.4	2.3	2.3
J	-210	1200	-150	1200	1.6	1.5	1.5
			-210	-150	2.7	2.6	2.5
K	-270	1372	-100	1200	1.5	1.4	1.4
			-200	-100	2.7	2.6	2.6
N	-270	1300	-100	1300	1.5	1.3	1.3
			-200	-100	3.0	2.7	2.6
R	-50	1768	300	1760	2.0	1.4	1.3
			-50	300	5.0	3.1	2.6
S	-50	1768	400	1760	2.1	1.6	1.4
			-50	400	4.5	2.8	2.4
T	-270	400	-100	400	1.5	1.4	1.4
			-200	-100	2.7	2.5	2.5

Table 2. Measurement accuracy of the U2355A at 0 to 18 °C and 28 to 45 °C

Thermocouple measurement accuracy (U2355A @ 0 to 18 °C and 28 to 45 °C)							
T/C type	ITS-90 Temperature range (°C)		Optimum measurement range (°C)		Without averaging (± °C)	50 points averaging (± °C)	500 points averaging (± °C)
	Low	High	Low	High			
B	0	1820	1100	1820	3.4	2.4	2.2
			400	1100	7.5	3.6	2.2
E	-270	1000	-150	1000	2.7	2.6	2.5
			-200	-150	3.8	3.6	3.6
J	-210	1200	-150	1200	2.5	2.4	2.4
			-210	-150	4.2	4.0	3.9
K	-270	1372	-100	1200	2.9	2.8	2.8
			-200	-100	4.3	4.0	3.9
N	-270	1300	-100	1300	2.6	2.5	2.5
			-200	-100	4.9	4.2	4.0
R	-50	1768	300	1760	3.8	3.1	3.0
			-50	300	8.5	4.6	3.3
S	-50	1768	400	1760	4.2	3.4	3.2
			-50	400	7.7	4.2	3.1
T	-270	400	-100	400	2.4	2.2	2.2
			-200	-100	4.3	4.3	3.9

Table 3. Measurement accuracy of the U2356A at 0 to 18 °C and 28 to 45 °C

Thermocouple measurement accuracy (U2356A @ 0 to 18 °C and 28 to 45 °C)							
T/C type	ITS-90 Temperature range (°C)		Optimum measurement range (°C)		Without averaging (± °C)	50 points averaging (± °C)	500 points averaging (± °C)
	Low	High	Low	High			
B	0	1820	1100	1820	6.1	3.1	2.4
			400	1100	14.4	6.3	2.7
E	-270	1000	-150	1000	3.0	2.6	2.6
			-200	-150	4.2	3.7	3.6
J	-210	1200	-150	1200	2.9	2.5	2.5
			-210	-150	4.9	4.1	4.0
K	-270	1372	-100	1200	3.3	2.9	2.9
			-200	-100	5.3	4.2	4.0
N	-270	1300	-100	1300	3.4	2.7	2.6
			-200	-100	6.8	4.6	4.1
R	-50	1768	300	1760	6.2	3.7	3.2
			-50	300	15.7	7.2	3.8
S	-50	1768	400	1760	6.4	4.0	3.4
			-50	400	14.2	6.6	3.4
T	-270	400	-100	400	3.0	2.4	2.2
			-200	-100	5.3	4.2	3.9

Optional Accessories for USB Modular DAQ

Introduction

The U2901A/U2902A is a terminal block and SCSI-II 68-pin connector with 1 meter cable or 2 meter cable that can be used conjunction with the U2300A Series and U2500A Series.

The U2903A/U2904A is a terminal block and SCSI-II 100-pin connector with 1 meter cable or 2 meter cable are that can be used conjunction with the U2600A Series.

These two terminal blocks have different pin configurations that can only be matched to the corresponding series.

U2901/U2902A – Terminal block and SCSI-II 68-pin connector with 1-meter/2-meter cable

Terminal block overview

Front view

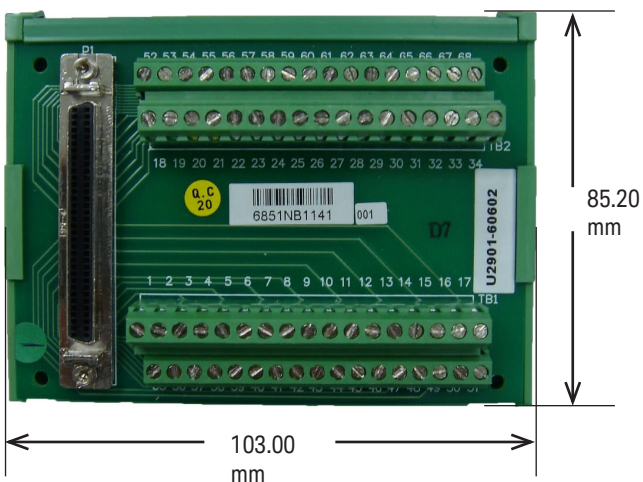

Side view

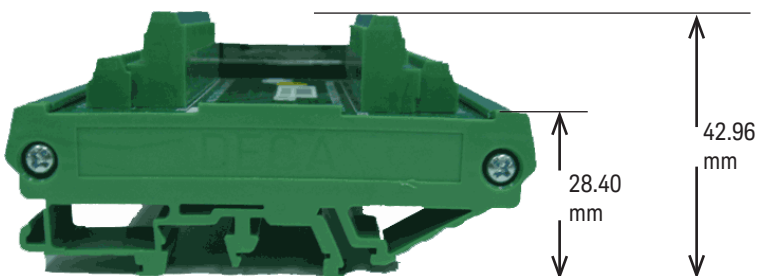

U2903/U2904A - Terminal block and SCSI-II 100-pin connector with 1-meter/2-meter cable

Terminal block overview

Front view

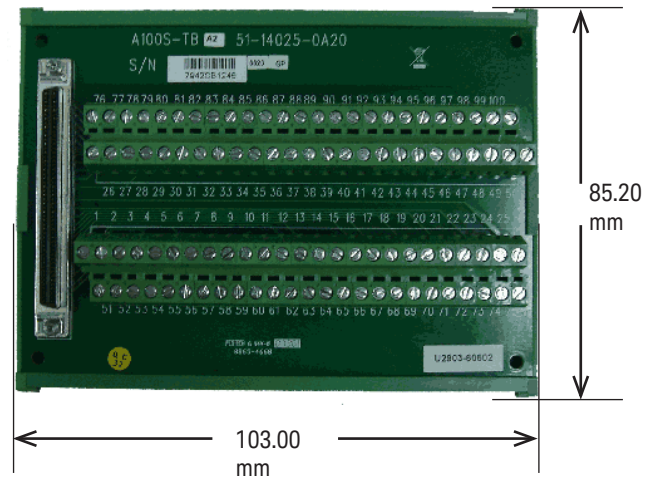

Side view

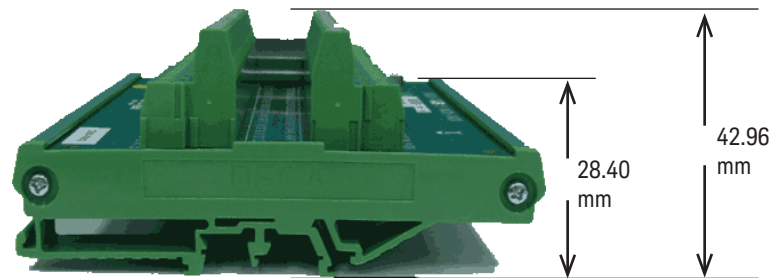

Keysight USB Modular Test Instrument Modules

Keysight's growing family of USB-based modular test instruments now includes oscilloscopes, a function generator, source measure unit, switch matrix, and a digital multimeter while the series of data acquisition family consists of numerous modules. This makes electronic functional test, troubleshooting, data logging, and measurement effortless. These devices offer the flexibility of standalone or modular operation for easy, affordable measurements and analysis. Kick start your measurements with a USB interface to your PC and the easy-to-use, feature-packed software bundled with each instrument.



A quick reference to the Keysight USB modular test instruments family

Modules	Description
U2701A USB Modular Oscilloscope, 100 MHz	The U2701A is a 2 channel 8-bit 100 MHz oscilloscope.
U2702A USB Modular Oscilloscope, 200 MHz	The U2702A is a 2 channel 8-bit 200 MHz oscilloscope.
U2722A USB Modular Source Measure Unit	The U2722A is a 3 channel 20 V/120 mA source measure unit that can operate in a 4-quadrant operation.
U2723A USB Modular Source Measure Unit	The U2723A is a 3 channel 20 V/120 mA source measure unit that can operate in a 4-quadrant operation, and includes embedded test scripts.
U2741A USB Modular Digital Multimeter, 5½ digit	The U2741A is a 5½-digit resolution digital multimeter that is able to capture up to 100 readings/sec.
U2751A 4×8 2 Wire USB Modular Switch Matrix	The U2751A offers a flexible connection path between the device under test and test equipment, thus allowing different instruments to be connected to multiple points on the device under test at the same time. This instrument offers measurement at a higher bandwidth up to 45 MHz.
U2761A USB Modular Function/Arbitrary Generator	The U2761A is a 20 MHz function generator that offers 10 standard waveforms plus pulse and arbitrary waveforms generation capabilities.

U2701A and U2702A USB Modular Oscilloscope

Features

- 100 MHz and 200 MHz bandwidths
- Up to 1GSa/s maximum sample rate
- 32 Mpts of waveform memory
- Compact and portable size – 117.00 mm × 180.00 mm × 41.00 mm (with rubber bumpers)
- Advanced triggering, including edge, pulse width, and TV
- Compatibility with Hi-Speed USB 2.0 and USBTMC-USB488 standards
- Four math functions, including FFTs standard
- DUAL-PLAY – standalone and modular capability
- Compatibility with wide range of application development environments



Highest performance, lowest cost for today and tomorrow

Keysight's U2701A and U2702A USB modular oscilloscopes combine a set of essential features that are ideal for analyzing designs in an affordable way.

The U2701A and U2702A come in two bandwidths: 100 MHz and 200 MHz respectively. These devices are uniquely designed to accommodate your needs for flexibility with the dual-play function. Dual-play functionality allows you to use the oscilloscope as a standalone or to scale up the test system in a cardcage with additional scopes or with Keysight's other USB modular product offerings, thus providing a complete solution for system development.

The U2701A and U2702A give you the debugging power you need. Each modular oscilloscope comes standard with features such as advanced triggering, automatic measurements, math functions including FFTs, and much more.

Why do you need Deep Memory and a High Sampling Rate?

To see more time

When you are able to store more samples that you have obtained in the memory, you can view the signal at a longer time. This will be the best way to understand the use of deep memory.

A longer capture time gives you a better visibility into cause-effect relationships in your designs, which significantly simplify your root-cause debugging. It also allows you to capture start-up events in a single acquisition.

The need to stitch together multiple acquisitions or set precise triggering conditions are no longer necessary. You can spend less time finding events, and more time analyzing them.

To see even more details

The relationship between memory depth and acquisition rate is not as obvious. All scopes have a “banner” maximum sample rate specification, but many can only sustain these rates at a few time base settings.

Higher sampling rate

By offering sampling rate more than twice the acquired signal bandwidth, aliasing can be prevented. With more sampling data captured, higher accuracy of your test and analysis results can be achieved.

Ease of use

The U2701A and U2702A USB modular oscilloscopes are equipped with Hi-Speed USB 2.0 interface for easy setup and plug-and-play. Hence, this ease-of-use makes the oscilloscopes ideal for the education, design validation, and manufacturing environment.



Figure 1. The dual-play capability allows U2701A and U2702A USB modular oscilloscopes to be used as standalone units or fitted into a cardcage.

Features you need

The U2701A and U2702A includes the following standard features that you need to perform your tasks efficiently:

Hi-Speed USB Interface

The U2701A and U2702A connect to the computer through Hi-Speed USB 2.0 connectivity.

Autoscale

Autoscale lets you display any active signals, automatically setting the vertical, horizontal, and trigger controls for the best signal display within the shortest time.

Advanced triggering

Edge, pulse width, and TV are the triggering modes included to help you isolate the signals you want to see.

Large memory

With memory depth up to 32 Mpts, you can capture even more data. Larger memory allows you to capture data over a longer time frame.

Fast Fourier Transfer (FFT) and Waveform Math

The U2701A and U2702A offer analysis functions such as addition, subtraction, multiplication, division, and Fast Fourier Transform (FFT). FFT allows you to manipulate the waveform using five types of windows such as Hanning, Hamming, Blackman-Harris, Flattop, and rectangular.

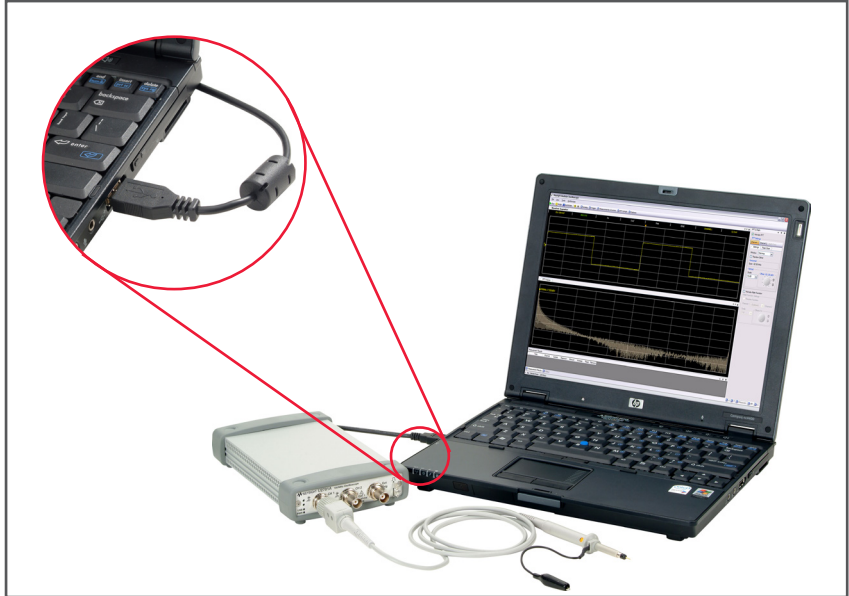

Figure 2. The U2701A and U2702A connect to the computer or laptop with a USB cable, enabling fast data transfer.

High sampling rate

Sampling rate up to 500 MSa/s/ch enables more details of the signal to be seen and analyzed. When two channels are interleaved, the sampling rate can be up to 1 GSa/s. This fast-sampling capability allows you to perform intermittent detection easily.

Pulse triggering

Pulse triggering allows you to trigger on pulse events.

Portability

The U2701A and U2702A's compact size makes them portable and easy to be carried to your working field.

Product outlook and dimensions

Front view



Rear view



Top view

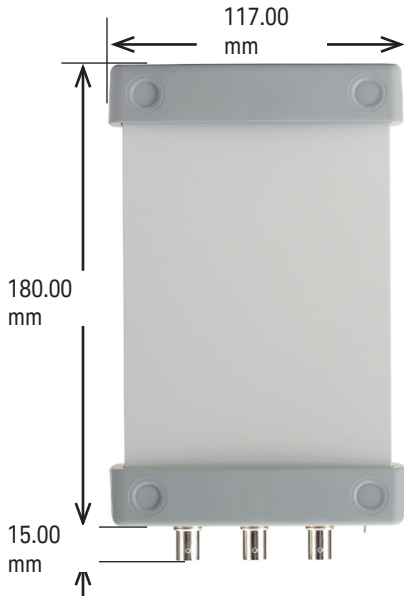

Standard shipped accessories

- 12 V, 2 A AC/DC Power adapter
- Power cord
- USB Standard A to Mini-B interface cable
- 2 x 10:1 Passive probe 150 MHz 1.2m, N2862A (only applicable for U2701A)
- 2 x 10:1 Passive probe 300 MHz 1.2m, N2863A (only applicable for U2702A)
- L-Mount kit (used with modular product chassis)
- Keysight Automation-Ready CD-ROM (contains the Keysight IO Libraries Suite)
- Keysight USB Modular Products Quick Start Guide
- Keysight USB Modular Products Reference CD-ROM
- Keysight USB Modular Products Quick Reference Card
- Certificate of Calibration

Product characteristics and general specifications

REMOTE INTERFACE

- Hi-Speed USB 2.0*
- USBTMC 488.2 Class device

POWER CONSUMPTION

- +12 VDC, 2 A
- Installation Category III

OPERATING ENVIRONMENT

- Operating temperature from 0 °C to +50 °C
- Operating humidity at 20% to 85% RH (non-condensing)
- Altitude up to 2000 meters
- Pollution Degree 2
- For indoor use only

STORAGE COMPLIANCE

- Storage temperature from -20 °C to 70 °C
- Storage humidity at 5% to 90% RH (non-condensing)

SAFETY COMPLIANCE

Certified with:

- IEC 61010-1:2001/EN 61010-1:2001 (2nd Edition)
- USA: UL61010-1: 2004
- Canada: CSA C22.2 No.61010-1:2004

EMC COMPLIANCE

- IEC 61326-1:2002/EN 61326-1:1998+A2:2001+A3:2003
- Canada: ICES-001:2004
- Australia/New Zealand: AS/NZS CISPR 11:2004

SHOCK AND VIBRATION

Tested to IEC/EN 60068-2

IO CONNECTOR

BNC connector

DIMENSION (W × D × H)

Module dimension:

- 117.00 mm × 180.00 mm × 41.00 mm (with bumpers)
- 105.00 mm × 175.00 mm × 25.00 mm (without bumpers)

WEIGHT

- 534 g (with bumpers)
- 482 g (without bumpers)

Optional accessories

- BNC cable, U2921A-100
- USB Secure cable, U2921A-101
- 1:1 Passive probe 20 MHz, 1.5 m, 10070C (Order no.: U2701A-200)
- 10:1 Passive probe 150 MHz 1.2m, N2862A (only applicable for U2701A)
- 10:1 Passive probe 300 MHz 1.2m, N2863A (only applicable for U2702A)

*If remote connections are necessary, a E5813A USB/LAN hub can be used. Please go to the product's user guide for more information.

Performance specifications¹

Vertical system: oscilloscope channels	
Bandwidth (-3 dB)	U2701A: DC to 100 MHz U2702A: DC to 200 MHz
Scope channel triggering	
Trigger sensitivity	< 10 mV/div: greater of 1 div or 5mV; ≥10 mV/div: 0.6 div

Performance characteristics²

Acquisition: oscilloscope channels	
Real time sample rate	
– 2 channels interleaved	1 GSa/s
– Each channel	500 MSa/s
Standard memory depth	Normal Single-shot
– 2 channels interleaved	32 Mpts 64 Mpts
– Each channel	16 Mpts 32 Mpts
Vertical resolution	8 bits
Peak detection	Yes
Averaging	Any number from 1 to 999
Filter	Sin(x)/x interpolation for time base 1 ns to 100 ns
Sweep modes	Auto, normal, single
Vertical system: oscilloscope channels	
Scope channels	U2701A/U2702A: Ch 1 and Ch 2 simultaneous acquisition
AC coupled	U2701A: 3.5 Hz to 100 MHz U2702A: 3.5 Hz to 200 MHz
Calculated rise time (= 0.35/bandwidth)	U2701A: 3.5 ns U2702A: 1.75 ns
Single-shot bandwidth	U2701A: 100 MHz U2702A: 200 MHz
Range	2 mV/div to 5 V/div (1 MΩ)
Maximum input ³	CAT I 30 Vrms, 42 Vpk
Offset range	±4 div Example: ±8 mV on 2 mV/div; ±20 V on 5 V/div
Dynamic range	±4 div
Input impedance	1 MΩ: ≈ 16 pF
Coupling	AC, DC, Ground
BW limit	≈ 25 MHz
Standard probes	10:1 Passive probe 150 MHz 1.2 m 10:1 Passive probe 300 MHz 1.2 m
ESD tolerance	±2 kV
Noise peak-to-peak	3 mVpp
DC vertical offset accuracy	≤ 200 mV/div: ±0.1 div ±2.0 mV ±0.5% offset value; > 200 mV/div: ±0.1 div ±2.0 mV ±1.5% offset value
DC vertical gain accuracy	±4.0% of full scale

¹ All specifications are warranted. specifications are valid after a 30-minute warm-up and within ±100 °C of last calibration temperature.

² All characteristics are typical performance values and are not warranted. Characteristics are valid after a 30-minute warm-up period and within ±10 °C of last calibration temperature.

³ Under standalone use, you are only allowed to measure up to CAT I 30 Vrms. For high-voltage measurement up to CAT I 300 Vrms, you must install the L-Mount kit on the U2701A/U2702A before plugging it into the product chassis. Ensure that the L-Mount kit installed on your modular oscilloscope is screwed to the product chassis to ensure proper chassis grounding. Note that you are required to use the provided 10:1 probes (N2862A/N2863A) for high-voltage measurements to avoid damaging your instrument.

Performance characteristics¹ (continued)

Vertical system: oscilloscope channels (continued)	
Single-cursor accuracy	±{DC vertical gain accuracy + DC vertical offset accuracy + 0.2% full scale (~1/2 LSB)} Example: For 50 mV signal, scope set to 10 mV/div (80 mV full scale), 5 mV offset, Accuracy = ±{4.0% (80 mV) + 0.1(10 mV) + 2.0 mV + 0.5% (5 mV) + 0.2% (80 mV)} = ±6.385 mV
Dual-cursor accuracy	±{DC vertical gain accuracy + 0.4% full scale (~1 LSB)} Example: For 50 mV signal, scope set to 10 mV/div (80 mV full scale), 5 mV offset, Accuracy = ±{4.0% (80 mV) + 0.4% (80 mV)} = ±3.52 mV
Horizontal	
Range	1 ns/div to 50 s/div
Time base accuracy	20 ppm
Delay range	Pre-trigger: -100 % Post-trigger: +100 %
Modes	Main, roll, XY
XY	Yes
Reference position	Center
Trigger System	
Sources	Ch 1, Ch 2, Ext (not applicable for TV trigger)
Modes	Normal, single, auto trigger
Holdoff time	60 ns
Selections	Edge, pulse width, TV
– Edge	Triggers on a rising or falling edge, alternating, or either edge of any source
– Pulse width	Triggers on a pulse width greater than, equal to, or less than a specified time limit, with time limits ranging from 16 ns to 10 s. – Minimum lower limit: 8 ns – Minimum upper limit: 16 ns – Maximum pulse width setting: 10 s
– TV	Triggers on one of three standard television waveforms: NTSC, PAL, SECAM TV trigger sensitivity: 0.6 division of sync signal. Modes supported include Field 1, Field 2, all fields, or any line within a field.
Autoscale	Single-button automatic setup of all channels
Oscilloscope channel triggering	
Range (internal)	±4 div from center screen
Coupling	AC (< 15 Hz) LF reject (~ 35 kHz) HF reject (~ 35 kHz)
External (EXT) triggering	
Input impedance	1 MW: ≈ 16 pF
Maximum input	CAT I 30 Vrms, 42 Vpk
Range	DC coupling: trigger level ±1.25 V and ±2.5 V
EXT trigger pulse width	> 2.5 ns

¹ All specifications are warranted. specifications are valid after a 30-minute warm-up and within ±100 °C of last calibration temperature.

Performance characteristics¹ (continued)

External (EXT) triggering (continued)	
Trigger level sensitivity	For ±1.25 V range setting: DC to 100 MHz: 100 µV > 100 MHz: 200 µV For ±2.5 V range setting: DC to 100 MHz: 250 µV > 100 MHz: 500 µV
Display	
Interpolation	Sin(x)/x
Display types	Dots and vectors
Persistence	Off, infinite
Format	XY, roll
Measurement features	
Automatic measurements	Measurements are continuously updated. Cursors track last selected measurement.
Voltage	Peak-to-peak, maximum, minimum, average, amplitude, top, base, Vrms, overshoot, preshoot, crest, standard deviation, cycle RMS, RMS AC
Time	Frequency, period, +width, -width, +duty cycle, -duty cycle, rise time, fall time, delay, phase
Frequency	Maximum peak
Cursors	- Modes: Manual - Type: Time, voltage and frequency (FFT) - Measurements: DT, DV, frequency, Peak Scan (FFT), DPeak
Math functions	Add, subtract, multiply, FFT, divide
FFT	
Points	1250 points (for 500 ns and above)
Source of FFT	Source channels 1 or 2
Window	Hanning, Hamming, Blackman-Harris, Rectangular, Flattop
Noise floor	-50 dB to -90 dB depending on averaging
Amplitude	Display in dBV
Maximum frequency	250 MHz

¹ All specifications are warranted. specifications are valid after a 30-minute warm-up and within ±100 °C of last calibration temperature.

U2722A/U2723A USB Modular Source Measure Unit

Features

- Three-channel SMU
- Four-quadrant operation (± 20 V)
- Maximum current output of 120 mA per channel
- Embedded test script (able to support three channels with coherent source and measurement capabilities) (for U2723A)
- IV Curve application support in the Keysight Measurement Manager software (for U2723A)
- Faster rise/fall time (for U2723A)
- High measurement sensitivity of 100 pA with 16-bit resolution
- 0.1% basic accuracy
- Low current measurement capability down to nA levels
- Voltage and current programming/readback
- USB 2.0 and USBTMC-USB488 standards
- Command logger function
- Wide range of Application Development Environments (ADEs) compatibility
- Standalone and modular
- SCPI and IVI-COM supported

Memory List

The U2723A USB Modular Source Measure Unit provides an embedded test script to help you pre-define test configurations or duplicate tests easily without spending too much time on programming.

Each channel in the U2723A USB Modular Source Measure Unit is allocated two memory lists, each capable of storing up to 200 commands and results individually. Stored commands in active memory will be executed accordingly while the measurement results obtained are automatically stored in the result buffer.

Introduction

The Keysight U2722A/U2723A USB modular source measure unit is more than just a power supply – it has fast response time, and has voltage and current programming/readback with high accuracy measurement capabilities. The U2722A and its enhanced version, the U2723A are capable of four-quadrant operation, acting as current source and also as current sink (load) with both polarities of the output voltage. The U2723A offers additional features such as embedded test scripts to simplify automated testing and faster rise time to help improve throughput during mass testing of semiconductor component.

Increases productivity and accuracy in automated testing

- Four-quadrant operations well suited for a wide range of test applications with just a single SMU
- High measurement sensitivity of 100 pA with 16-bit resolution allowing you to source and measure down to pico levels
- 0.1% accuracy for getting more accurate analysis and measurement results
- Flexible standalone or modular capability enables you to have lower startup cost
- SCPI and IVI-COM supported and a wide range of ADEs compatibility minimize your work time and increase software options
- Easy-to-use KMM software that includes the command logger function that helps you easily convert SCPI commands into snippets of VEE, VB, C++, and C# code



Four-quadrant operations with high measurement sensitivity and accuracy

The U2722A/U2723A SMU is a versatile device that allows you to perform sweep and measurement from different operating regions with just a single device without extra configurations. The four quadrant-operation (± 20 V) makes the U2722A/U2723A well suited for a wide range of test applications including leakage measurement, solar cell measurement, forward/reverse voltage, curve tracer transistor, and many others. Besides being versatile, the U2722A/U2723A offers high measurement sensitivity with 16-bit resolution and accuracy that allows you to obtain more accurate analysis and measurement results.

Product outlook and dimensions

Front view

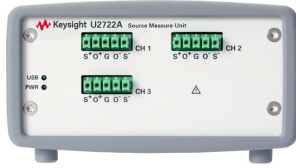

Rear view



Top view

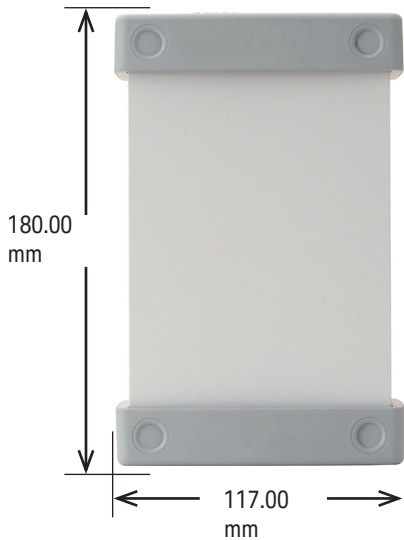

Standard shipped accessories

- 12 V, 3 A AC/DC Power adapter
- Power cord
- Plug-in connectors and cable casing
- USB Standard-A to Mini-B interface cable
- L-Mount kit (used with modular product chassis)
- Keysight USB Modular Products Quick Start Guide
- Keysight Measurement Manager Quick Reference Card
- Keysight USB Modular Products Reference CD-ROM
- Keysight Automation-Ready CD-ROM (contains the Keysight IO Libraries Suite)
- Certificate of Calibration

Optional accessories

- USB secure 2-m cable

Product characteristics and general specifications

REMOTE INTERFACE

- Hi-Speed USB 2.0*
- USBTMC-USB488¹

POWER CONSUMPTION

- +12 VDC, 3 A maximum
- Isolated ELV supply source

OPERATING ENVIRONMENT

- Operating temperature from 0 °C to +50 °C
- Relative humidity at 20% to 85% RH (non-condensing)
- Altitude up to 2000 meters
- Pollution Degree 2
- For indoor use only

STORAGE COMPLIANCE

-20 °C to 70 °C

SAFETY COMPLIANCE

Certified with:

- IEC 61010-1:2001/EN 61010-1:2001 (2nd Edition)
- USA: ANSI/UL 61010-1:2004
- Canada: CSA C22.2 No.61010-1:2004

EMC COMPLIANCE

- IEC 61326-1:2002/EN 61326-1:1997+A2:2001+A3:2003
- Canada: ICES-001:2004
- Australia/New Zealand: AS/NZS CISPR 11:2004

SHOCK AND VIBRATION

Tested to IEC/EN 60068-2

IO CONNECTOR

Output connectors

DIMENSION (W × D × H)

Module dimension:

- 117.00 mm × 180.00 mm × 66.00 mm (with bumpers)
- 105.00 mm × 175.00 mm × 50.00 mm (without bumpers)

WEIGHT

Module dimension:

- 700 g (with bumpers)
- 650 g (without bumpers)

¹ Compatible with Microsoft Windows operating systems only.

*If remote connections are necessary, a E5813A USB/LAN hub can be used. Please go to the product's user guide for more information.

Product specifications

General

Model	U2722A/U2723A
Number of outputs	3
Output ratings (at 0 °C to 50 °C)	
Voltage	-20 V to 20 V
Current	-120 mA to 120 mA

Performance specification

U2722A/U2723A	Range	Accuracy ¹	Resolution
Voltage programming 12 months (at 25 °C ± 3 °C), ±(% of output + offset)	±2 V	0.075% + 1.5 mV	0.1 mV
	±20 V	0.05% + 10 mV	1 mV
Current programming 12 months (at 25 °C ± 3 °C), ±(% of output + offset)	±1 µA	0.085% + 0.85 nA	100 pA
	±10 µA	0.085% + 8.5 nA	1 nA
	±100 µA	0.075% + 75 nA	10 nA
	±1 mA	0.075% + 750 nA	100 nA
	±10 mA	0.075% + 7.5 µA	1 µA
Voltage readback 12 months (over USB with respect to the actual output at 25 °C ± 3 °C), ±(% of output + offset)	±120 mA	0.1% + 100 µA	20 µA
	±2 V	0.075% + 1.5 mV	0.1 mV
	±20 V	0.05% + 10 mV	1 mV
Current readback 12 months (over USB with respect to the actual output at 25 °C ± 3 °C), ±(% of output + offset)	±1 µA	0.085% + 0.85 nA	100 pA
	±10 µA	0.085% + 8.5 nA	1 nA
	±100 µA	0.075% + 75 nA	10 nA
	±1 mA	0.075% + 750 nA	100 nA
	±10 mA	0.075% + 7.5 µA	1 µA
	±120 mA	0.1% + 100 µA	20 µA

¹ Accuracy measurements are based on NPLC 10.

Performance characteristics

Rise/fall time (ms) ¹		U2722A	U2723A
For resistive measurement ²	±1 µA	170.0	15.0
	±10 µA	18.0	5.0
	±100 µA	6.0	1.0
	±1 mA	1.0	1.0
	±10 mA	1.0	1.0
	±120 mA	1.0	1.0

Remote sense operating range	Ensure that the maximum voltage between the OUTPUT+ and SENSE+, OUTPUT-, and SENSE- does not exceed 3 V.
Temperature coefficient	Maximum change in output/readback per °C after a 30-minute warm-up is 0.15.
Guard output resistance	0.2 kΩ
Noise 10 Hz to 20 MHz (peak-peak)	100 mV typical into a resistive load (floating mode).
Output voltage overshoot, ±(% of output + offset) ²	During turn-on or turn-off, the output plus overshoot < 0.1% + 10 mV.
Programming language	SCPI (Standard Commands for Programmable Instruments)
Maximum sense lead resistance	1 MΩ for rated accuracy
Voltage line regulation	0.01% of range
Voltage load regulation	0.01% + 100 µV
Current line regulation	0.04% of range
Current load regulation	0.04% + 100 µA
Recommended calibration interval	One year

- NOTE
- All channels are isolated from the ground and from each other. Isolation is +60 VDC, Category 1.
 - All specifications are based on three hours warm-up time.
 - The measurement accuracy value is $x (1 + a * y)$, where,
 - x = accuracy specification at room temperature,
 - a = temperature coefficient, and
 - y = temperature change from room temperature in °C

Noise 10 Hz to 20 MHz (Peak-peak)

Voltage range	Current range					
	1 µA	10 µA	100 µA	1 mA	10 mA	120 mA
2 V	50 mV	50 mV	50 mV	50 mV	30 mV	30 mV
20 V	50 mV	50 mV	50 mV	50 mV	30 mV	30 mV

¹ Drive 50% of 1 V or 10 V output with a resistive load. Rise time is from 10% to 90% of program voltage change at maximum current. Fall time is from 90% to 10% of program voltage change at maximum current.

² Measurements obtained are per default bandwidth setting.

U2741A USB Modular Digital Multimeter

Features

- Makes fast measurements with up to 100 readings per second
- Measures up to 300 VDC with 5½-digits resolution
- Frequency and temperature measurement capability
- Wide voltage measurement range
 - DC: 1 µVDC to 300 VDC
 - AC: 1 µVrms to 250 Vrms
- Wide current measurement range
 - DC: 1 µADC to 2 ADC
 - AC: 1 µArms to 2 Arms
- Compatibility with Hi-Speed USB 2.0 and USBTMC-USB488 standards
- Dual-play – standalone and modular capability
- Bundled software – Keysight Measurement Manager (KMM)
- Wide range of compatible Keysight Development Environments (KDEs)

Introduction

The Keysight U2741A is a 5½-digits digital multimeter (DMM), which is the latest addition to the Keysight's USB modular family. It can operate as standalone or as a modular unit when used with the U2781A USB modular product chassis. It comes with various features and functions to meet your needs today.



Figure 1. The U2741A DMM showing dual-play capability

Various U2741A features to meet your demands

- Affordable and measures up to ten different measurements
- Quick and easy Hi-Speed USB 2.0 connectivity
- Dual-play capability allowing flexible configuration in simple or sophisticated test environment
- Easy-to-use bundled software to get you started with the DMM without programming
- Compatible with a wide range of ADEs to choose
- Portable, accurate, and reliable

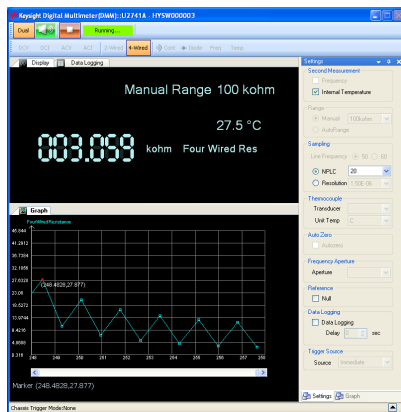

Figure 2. Example of the U2741A KMM Graphical User Interface

Value for money and feature-rich DMM

The U2741A DMM gives you an accurate 5.5 digits resolution. It offers a wide range of measurement functions and features despite its value price. The U2741A is capable of performing DC voltage, AC voltage, DC current, AC current, 2-wire resistance, 4-wire resistance, continuity, diode, frequency, and temperature measurement to meet the industrial needs.

Data logger function with KMM

The KMM software comes with data logger function that allows you to customize your data logging needs. Data can be stored for analysis when this option is enabled. The data capture interval range can be set from 0 s to 100 s. With this feature, you can start the U2741A to take measurement over duration and check your results when the test is completed. Data can be stored to a CSV (comma separated value) file format.

Product outlook and dimensions

Front view



Rear view



Top view

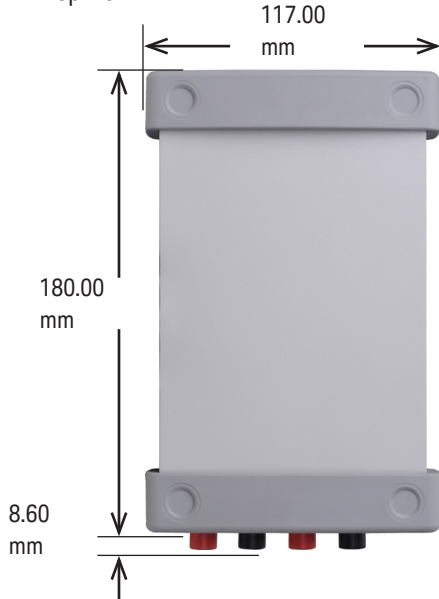

Standard shipped accessories

- 12 V, 2 A AC/DC Power adapter
- Power cord
- Standard test lead set
- USB Standard-A to Mini-B interface cable
- L-Mount kit (used with modular product chassis)
- Keysight USB Modular Products Quick Start Guide
- Keysight Measurement Manager Quick Reference Card
- Keysight USB Modular Products Reference CD-ROM
- Keysight Automation-Ready CD-ROM (contains the Keysight IO Libraries Suite)
- Certificate of Calibration

Optional accessories

- E2308A Thermistor temperature probe
- USB Secure 2-m cable

Product characteristics and general specifications

REMOTE INTERFACE

- Hi-Speed USB 2.0*
- USBTMC-USB488¹

POWER CONSUMPTION

- +12 VDC, 2 A maximum
- Isolated ELV supply source

OPERATING ENVIRONMENT

- Operating temperature from 18 °C to +28 °C
- Relative humidity at 50% RH (non-condensing)
- Altitude up to 2000 meters
- Pollution Degree 2
- For indoor use only

STORAGE COMPLIANCE

- Storage temperature from -20 °C to 70 °C
- Relative humidity at 5% to 90% RH (non-condensing)

SAFETY COMPLIANCE

Certified with:

- IEC 61010-1:2001/EN 61010-1:2001 (2nd Edition)
- USA: ANSI/UL 61010-1:2004
- Canada: CSA C22.2 No.61010-1:2004

EMC COMPLIANCE

- IEC 61326-1:2002/EN 61326-1:1997+A2:2001+A3:2003
- Canada: ICES-001:2004
- Australia/New Zealand: AS/NZS CISPR 11:2004

MEASUREMENT COMPLIANCE

CAT II 300 V Over-voltage protection

COMMON MODE REJECTION RATIO (CMRR)

- DC CMRR > 120 dB with 1k unbalanced load
- AC CMRR > 70 dB at 50/60 Hz $\pm 0.1\%$ with 1k unbalanced load

NORMAL MODE REJECTION RATIO (NMRR)

- > 60 dB at 50/60 Hz $\pm 0.1\%^2$
- > 0 dB at 50/60 Hz $\pm 0.1\%^3$

SHOCK AND VIBRATION

Tested to IEC/EN 60068-2

IO CONNECTOR

Four banana socket terminals

DIMENSION (W × D × H)

Module dimension:

- 117.00 mm × 180.00 mm × 41.00 mm (with bumpers)
- 105.00 mm × 175.00 mm × 11.50 mm (without bumpers)

WEIGHT

- 509 g (with bumpers)
- 451 g (without bumpers)

CALIBRATION

Calibration interval of one year is highly recommended

¹ Compatible with Microsoft Windows operating systems only.

² Applicable for NPLC > 1.

³ Applicable for NPLC 0.2 and 0.02

*If remote connections are necessary, a E5813A USB/LAN hub can be used. Please go to the product's user guide for more information.

Product specifications

DC specifications¹

Function	Range	Input impedance	Test current/ Burden voltage, Shunt resistance	Accuracy ±(% of reading + % of range)	Temperature coefficient 0 °C to 18 °C 28 °C to 55 °C
Voltage ²	100.000 mV	10 MΩ	-	0.015 + 0.008	0.002 + 0.0008
	1.00000 V	10 MΩ	-	0.015 + 0.005	0.001 + 0.0005
	10.0000 V	10 MΩ	-	0.018 + 0.005	0.002 + 0.0005
	100.000 V	10 MΩ	-	0.018 + 0.005	0.002 + 0.0005
	300.000 V	10 MΩ	-	0.018 + 0.005	0.002 + 0.0005
Current ³	10.0000 mA	-	< 0.2 V, 10 Ω	0.06 + 0.015	0.005 + 0.0025
	100.000 mA	-	< 0.2 V, 1 Ω	0.06 + 0.005	0.008 + 0.002
	1.0000 A	-	< 0.3 V, 0.1 Ω	0.15 + 0.007	0.005 + 0.002
	2.0000 A	-	< 0.8 V, 0.1 Ω	0.15 + 0.007	0.005 + 0.002
Resistance ⁴	100.000 Ω	-	1.0 mA	0.03 + 0.008	0.006 + 0.0008
	1.00000 kΩ	-	1.0 mA	0.03 + 0.005	0.006 + 0.0005
	10.0000 kΩ	-	100 μA	0.03 + 0.005	0.006 + 0.0005
	100.000 kΩ	-	10.0 μA	0.03 + 0.005	0.006 + 0.0005
	1.00000 MΩ	-	1 μA	0.06 + 0.005	0.01 + 0.0005
	10.0000 MΩ	-	225 nA	0.25 + 0.005	0.025 + 0.0005
Diode test ⁵	100.000 MΩ	-	225 nA 10 MΩ	2.0 + 0.005	0.3 + 0.0005
Diode test ⁵	1.0000 V	-	1.00 mA	0.015 + 0.03	0.005 + 0.0005
Continuity test ⁶	1.0000 kΩ	-	1.00 mA	0.05 + 0.03	0.005 + 0.0005

NOTE To ensure better measurement results and to guard against the change of environment or setup, always enable the Null offset.

¹ Specifications are based on 30 minutes warm-up time, NPLC 20 resolution, and calibration temperature within 18 °C to 28 °C. For NPLC 0 and 0.025, add 0.01% of range.

² 120% over range on all ranges except 300 VDC. Input protection up to 300 VDC.

³ Input protected with externally accessible 2 A, 250 V fast blown fuse.

⁴ Specifications are for 4-wire Ω or 2-wire Ωs using null function in KMM software. If without null function in KMM software, add 0.2 Ω additional error. Input protection up to 300 VDC. Specifications apply for NPLC ≥ 1.

⁵ Specifications are for the voltage measured at the input terminals only.

⁶ Continuity threshold is fixed at less than 10 Ω.

AC specifications¹

AC accuracy for voltage

Function	Range	Accuracy input \pm (% of reading + % of range)			
		Frequency (Hz)			
		20 ~ 45	45 ~ 10k	10k ~ 30k	30k ~ 100k ³
Voltage ²	100.000 mVrms	1 + 0.1	0.2 + 0.1	1.5 + 0.3	5.0 + 0.3
	1.00000 V	1 + 0.1	0.2 + 0.1	1.0 + 0.1	3.0 + 0.2
	10.0000 V	1 + 0.1	0.3 + 0.1	1.0 + 0.1	3.0 + 0.2
	100.000 V	1 + 0.1	0.3 + 0.1	1.0 + 0.1	3.0 + 0.2
	250.000 V ⁴	1 + 0.1	0.3 + 0.1	1.0 + 0.1	3.0 + 0.2

Temperature coefficient for voltage (0 °C to 18 °C, 28 °C to 55 °C)

Function	Range	Accuracy input \pm (% of reading + % of range)			
		Frequency (Hz)			
		20 ~ 45	45 ~ 10k	10k ~ 30k	30k ~ 100k
Temperature coefficient	100.000 mVrms				
	1.00000 V				
	10.0000 V	0.02 + 0.02	0.02 + 0.02	0.05 + 0.02	0.1 + 0.02
	100.000 V				
	250.000 V				

AC accuracy for current¹

Function	Range	Burden voltage, Current shunt resistance	Accuracy input \pm (% of reading + % of range)		
			Frequency (Hz)		
			20 ~ 45	45 ~ 1k	1k ~ 10k
Current ⁵	10.0000 mA	< 0.2 V, 10 Ω	1.5 + 0.1	0.5 + 0.1	2 + 0.2
	100.000 mA	< 0.2 V, 1 Ω	1.5 + 0.1	0.5 + 0.1	2 + 0.2
	1.00000 A	< 0.3 V, 0.1 Ω	1.5 + 0.1	0.5 + 0.1	2 + 0.2
	2.00000 A	< 0.8 V, 0.1 Ω	1.5 + 0.1	0.5 + 0.1	2 + 0.2

Temperature coefficient for current (0 °C to 18 °C, 28 °C to 55 °C)

Function	Range	Accuracy input \pm (% of reading + % of range)		
		Frequency (Hz)		
		20 ~ 45	45 ~ 10k	10k ~ 30k
Temperature coefficient	10.0000 mA			
	100.000 mA	0.02 + 0.02	0.02 + 0.02	0.02 + 0.02
	1.00000 A			
	2.00000 A			

NOTE To ensure better measurement results and to guard against the change of environment or setup, always enable the Null offset.

¹ Specifications are based on 30 minutes warm-up time and calibration temperature within 18 °C to 28 °C. In manual range, the settling time is 2.6 seconds while in autorange, the first measurement accuracy is < 1%.

² Specifications are for sine wave inputs more than 5% of range. 120% over range on all ranges except 250 VAC. Maximum crest factor of 5 at full scale. Input impedance is 1 M Ω in parallel with capacitance less than 120 pF, AC couple with up to 300 VDC.

³ Additional error to be added as frequency more than 30 kHz and signal input less than 10% of range. 30 kHz to 100 kHz: add 0.003% of range per kHz.

⁴ Input signal has to be more than 50 Vrms.

⁵ Input protected with externally accessible 2 A, 250 V fast blown fuse.

Frequency specifications¹

Frequency accuracy

Function	Range	Accuracy (% of reading + % of range)	Minimum input frequency	Temperature coefficient (% of range)
Frequency	20 Hz to 300 kHz	0.0200 + 0.003	1 Hz	0.005

Frequency Sensitivity for AC Voltage

Function	Range	Minimum sensitivity (RMS sine wave) Frequency (Hz)	
		20 ~ 100k	100k ~ 300k
AC voltage	100 mV ²	20 mV	20 mV
	1 V	100 mV	120 mV
	10 V	1 V	1.2 V
	100 V	10 V	20 V
	250 V	100 V	120 V

Temperature specifications

Temperature accuracy

Function	Thermistor type	Range	Accuracy	Temperature coefficient
Temperature	5 kΩ thermistor	-80.0 °C to 150 °C -112 °F to 302 °F	Probe accuracy + 0.2 °C	0.002 °C

NOTE To ensure better measurement results and to guard against the change of environment or setup, always enable the Null offset.

Typical Reading Speed (in seconds) Characteristics

Test/Range	100 mV(20 Hz)	1V(20 Hz)	10V(20Hz)	100V(45 Hz)	300V(45 Hz)
ACV	0.979	0.979	0.978	0.979	0.979

Test/Range	10 mA	100 mA	1 A	2 A
ACI	0.979	0.979	0.979	0.979

Freq	1.190
------	-------

¹ Frequency measurement can only be done in auto range mode. Specifications are for 30 minutes warm-up time, using one second aperture. Measuring method is using reciprocal counting technique with AC coupled input at AC voltage function. Gate time of 0.1 second or 1 second.

² Only applicable for square wave measurement.

Test	Range/NPLC	20	10	2	1	0.025	0
DCV	100 mV	0.413	0.213	0.053	0.033	0.016	0.016
	1 V	0.414	0.213	0.053	0.033	0.016	0.016
	10 V	0.413	0.213	0.053	0.033	0.016	0.016
	100 V	0.414	0.214	0.053	0.033	0.016	0.016
	300 V	0.413	0.213	0.053	0.033	0.016	0.016
DCI	10 mA	0.413	0.214	0.053	0.033	0.016	0.016
	100 mA	0.393	0.213	0.053	0.033	0.016	0.016
	1 A	0.414	0.213	0.053	0.033	0.016	0.016
	2 A	0.413	0.213	0.053	0.033	0.016	0.016
2W	100 Ω	0.414	0.214	0.053	0.033	0.016	0.016
	1 kΩ	0.414	0.213	0.053	0.033	0.016	0.016
	10 kΩ	0.413	0.214	0.054	0.033	0.016	0.016
	100 kΩ	0.413	0.213	0.053	0.033	0.016	0.016
	1 MΩ	0.413	0.213	0.053	0.033	0.016	0.016
	10 MΩ	0.413	0.213	0.053	0.033	0.016	0.016
	100 MΩ	0.413	0.214	0.053	0.033	0.016	0.016
4W	100 Ω	0.863	0.461	0.141	0.102	0.063	0.062
	1 kΩ	0.830	0.431	0.110	0.069	0.030	0.030
	10 kΩ	0.829	0.430	0.110	0.069	0.030	0.030
	100 kΩ	0.830	0.430	0.110	0.069	0.030	0.030
	1 MΩ	0.831	0.431	0.110	0.070	0.030	0.030
	10 MΩ	0.986	0.585	0.265	0.225	0.186	0.185
	100 MΩ	0.986	0.585	0.265	0.225	0.186	0.186

Test Conditions of PC and USB DMM Module

- Processor: Intel Core2 Duo Processor E8400 3.00 GHz, 6 MB L2 cache, 1333 MHz FSB
- Memory : 2GB DDR2
- Hard Disk Drive (HDD): 160GB
- Microsoft Windows XP
- Professional Version 2002, Service Pack 2.
- The module is loaded with FW revision 1.12 and running with KMM version is 1.8.7.0

U2751A USB Modular Switch Matrix

Features

- 32 two-wire crosspoints in 4x8 configuration
- Minimal crosstalk at up to 45 MHz
- Bandwidth of 45 MHz without the terminal block
- Relay cycle counter
- Flexible connection configurations
 - capable of multiple closed channels simultaneously
- Hi-Speed USB 2.0 (480 Mbps)
- Bundled software – Keysight Measurement Manager (KMM)
- Command logger function
- Wide range of Application Development Environments (ADEs) compatibility
- Standalone and modular
- SCPI and IVI-COM supported
- USB 2.0 and USBTMC-USB488 standards



Introduction

The Keysight U2751A USB modular switch matrix offers a high-quality, low-cost switching solution for automated testing. It has 32 two-wire cross points organized in a four rows by eight columns (4x8) configuration enabling connection with any combination of rows and columns, including multiple channels at the same time. It also features a relay cycle counter.

Affordable, reliable, and flexible switching solution

- Minimal crosstalk at up to 45 MHz for more accurate measurements
- Bandwidth of 45 MHz without terminal block allows you to perform high bandwidth measurements with minimum insertion loss
- Work in comfort and convenience with the bundled KMM software on your PC with quick and easy installation
- Flexible standalone or modular capability enables you to have lower startup cost
- SCPI and IVI-COM supported and a wide range of ADEs compatibility minimize your work time and increase software options
- Easy-to-use KMM software that includes the command logger function that helps you easily convert SCPI commands into snippets of VEE, VB, C++, and C# code.



Flexible connection with minimal crosstalk

The U2751A offers you the most flexible connection path between your device under test (DUT) and your test equipment, allowing different instruments to be connected to multiple points on your DUT at the same time. In addition to this flexible connection path, the U2751A has minimal crosstalk that allows you to have more accurate measurements with wider range of test applications.



Keysight U2922A 32-Channel Terminal Block

The U2922A terminal block is an optional accessory to be used with the U2751A. The U2922A, which weighs approximately 100 g with screw-type terminals, offers you a convenient and simple way of making connection to the switch matrix for prototyping applications or an actual system deployment. It allows the user to configure a wide variety of routing options and matrix topologies.



Figure 1. U2922A with U2751A used as a standalone device

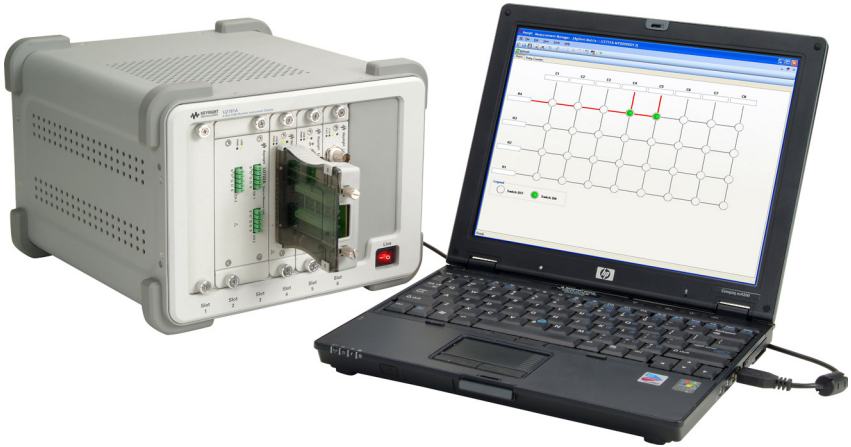

Figure 2. U2751A with U2922A used as a modular device

Product outlook and dimensions

Front view



Rear view



Top view

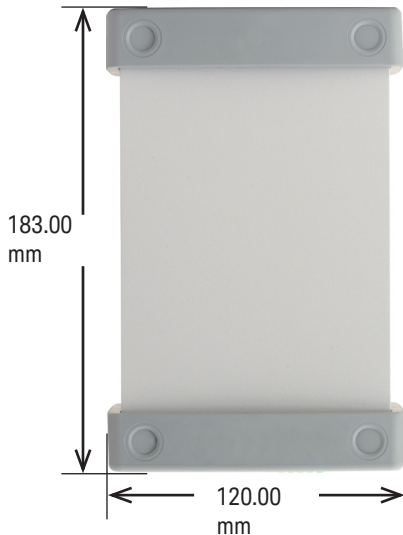

Standard shipped accessories

- 12 V, 2 A AC/DC Power adapter
- Power cord
- Plug-in connectors and cable casing
- USB Standard-A to Mini-B interface cable
- L-Mount kit (used with modular product chassis)
- Keysight USB Modular Products Quick Start Guide
- Keysight Measurement Manager Quick Reference Card
- Keysight USB Modular Products Reference CD-ROM
- Keysight Automation-Ready CD-ROM (contains the Keysight IO Libraries Suite)
- Certificate of Calibration

Optional accessories

- U2922A 32-channel terminal block
- USB secure 2-m cable

Product characteristics and general specifications

REMOTE INTERFACE

- Hi-Speed USB 2.0*
- USBTMC-USB488¹

POWER CONSUMPTION

- +12 VDC, 2 A maximum
- Installation Category II

OPERATING ENVIRONMENT

- Operating temperature from 0 °C to +50 °C
- Relative humidity at 20% to 85% RH (non-condensing)
- Altitude up to 2000 meters
- Pollution Degree 2
- For indoor use only

STORAGE COMPLIANCE

Storage temperature from -20 °C to 70 °C

SAFETY COMPLIANCE

Certified with:

- IEC 61010-1:2001/EN 61010-1:2001 (2nd Edition)
- USA: ANSI/UL 61010-1:2004
- Canada: CSA C22.2 No.61010-1:2004

EMC COMPLIANCE

- IEC 61326-1:2002/EN 61326-1:1997+A2:2001+A3:2003
- Canada: ICES-001:2004
- Australia/New Zealand: AS/NZS CISPR 11:2004

MEASUREMENT COMPLIANCE

CAT II 300 V Over-voltage protection

SHOCK AND VIBRATION

Tested to IEC/EN 60068-2

IO CONNECTOR

DSub 25 male

DIMENSION (W × D × H)

Module dimension:

- 120.00 mm × 183.00 mm × 44.00 mm (with bumpers)
- 105.00 mm × 175.00 mm × 25 mm (without bumpers)

WEIGHT

- 480 g (with bumpers)
- 428 g (without bumpers)

¹ Compatible with Microsoft Windows operating systems only.

*If remote connections are necessary, a E5813A USB/LAN hub can be used. Please go to the product's user guide for more information.

Product specifications

Model	U2751A	
	Without U2922A terminal block	With U2922A terminal block
Channels/configuration	4 × 8, 2-wire	
Switch type	Armature latching	
Input characteristics (per channel)		
Max working voltage ¹		
– Standalone	42 VDC/35 Vrms	
– Modular (Used with U2781A)	180 VDC/180 Vrms	
Max transient voltage	300 Vrms	
Max current		
– Switch current	2 A	
– Carry current	2 A	
Power (W, VA) ²	60 W, 62.5 VA	
Volt-Hertz limit	108	
General specification		
Thermal emf (differential)	< 3 µV	
Initial closed channel resistance	< 1.5 Ω	
DC isolation (ch-ch, ch-earth)	> 10 GΩ	
AC characteristics		
Bandwidth ³	45 MHz	30 MHz
Insertion loss	0.2 dB	0.2 dB
– 100 kHz	0.3 dB	0.3 dB
– 1 MHz	< 2 dB	< 2 dB
– 10 MHz	< 3 dB	< 4.5 dB
– 45 MHz		
Capacitance	55 pF	85 pF
– HI-LO	35 pF	45 pF
– LO-Earth		
Crosstalk at terminal block (ch-ch) ³		
– 300 kHz	–70 dB	
– 1 MHz	–60 dB	
– 20 MHz	–35 dB	
– 45 MHz	–30 dB	
General characteristics		
Relay life, typical		
– No load	100 M	
– 10 V, 100 mA	10 M	
– Related load	100 k	
Open/close time	4 ms/4 ms	

¹ DC or AC rms, channel-to-channel or channel-to-earth.

² Limited to 6 W channel resistance power loss per module.

³ 50 Ω source, 50 Ω load, differential measurements verified with a 4-port network analyzer (Sdd21).

U2761A USB Modular Function/Arbitrary Waveform Generator

Features

- 20 MHz Sine and Square waveforms
- Sine, Square, Ramp, Triangle, Pulse and DC waveforms
- 14-bit, 50 MSa/s, 64 k-points Arbitrary waveforms¹
- Optional arbitrary waveform generation upgrade (2 MHz)
- AM, FM, PM, ASK, FSK, and PSK modulation types
- 40 mVpp to 5 Vpp amplitude range (into 50 Ω load)
- Pulse generation
- Easy-to-use bundled software
- Arbitrary waveform editor
- Command logger function
- USB 2.0 and USBTMC-USB488 standards

Introduction

The Keysight U2761A is a 20 MHz USB modular function generator with arbitrary waveform and pulse generation capability. It can operate as a standalone or modular unit when used with the U2781A USB modular product chassis.

Various features of the U2761A

- Latest DDS technology adoption for more stable and accurate output signal
- Easy-to-use arbitrary waveform editor for easy customization of waveform generation
- Built-in modulation capability eliminates the need for a separate modulation source
- Pulse generation up to 5 MHz with variable period, pulse width, and amplitude that are ideal for wide variety of applications
- Wide range of Application Development Environment (ADE) compatibility
- Low start-up cost with standalone capability
- Flexibility in expanding your application when using it as modular unit with the U2761A
- Command logger function offered in the bundled software allows easy command conversion into VEE programs



Direct digital waveform

The U2761A adopts the latest direct digital synthesis (DDS) technology that digitally creates arbitrary waveforms and frequencies from a single and fixed frequency source. DDS offers the precision of digitally controlled logic—reducing the complexity of the generator while increasing the stability. Thus, allowing you to have a stable, accurate output signal for clean, low distortion sine waves and square waves with fast rise and fall time up to 20 MHz and linear ramp waves up to 200 kHz.

Pulse generation

The U2761A can generate pulses from 500 μ Hz to 5 MHz. With variable period, pulse width, and amplitude parameters, the U2761A is ideally suited to a wide variety of applications requiring flexible pulse width signals.

Internal modulation

Internal AM, FM, PM, ASK, FSK, and PSK modulation makes it easy to modulate waveforms without the need for a separate modulation source. Linear and logarithmic sweeps are also built in, with sweep rates selectable from 1 ms to 500 s.

Arbitrary waveform editor

With every purchase of the U2761A, it is bundled with an easy-to-use application software, the Keysight Measurement Manager. This application allows customization of waveforms generation.



¹ Maximum at 16 k points for Arbitrary waveforms when using bundled software, Keysight Measurement Manager (KMM) and 64 k points when programmed in compatible application development environments like Keysight VEE, NI LabVIEW, and Microsoft Visual Studio.

Product outlook and dimensions

Front view



Rear view



Top view

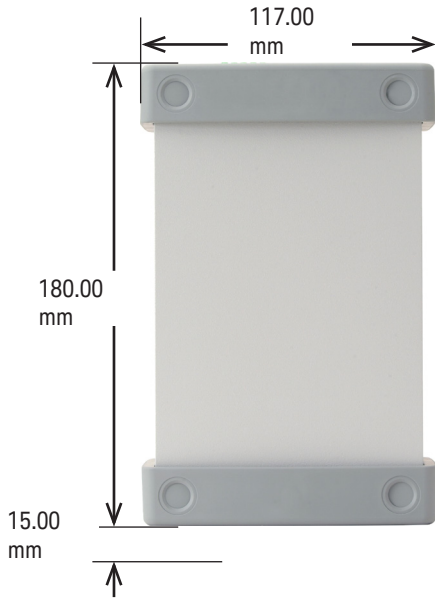

Standard shipped accessories

- 12 V, 2 A AC/DC Power adapter
- Power cord
- USB Standard A to Mini-B interface cable
- L-Mount kit (used with modular product chassis)
- Keysight Automation-Ready CD-ROM (contains the Keysight IO Libraries Suite)
- Keysight USB Modular Products Quick Start Guide
- Keysight USB Modular Products Reference CD-ROM
- Keysight USB Modular Products Quick Reference Card
- Certificate of Calibration

Optional accessories

- 1.5 m BNC coax cable
- USB Secure 2-m cable

Product characteristics and general specifications

REMOTE INTERFACE

- Hi-Speed USB 2.0*
- USBTMC-USB488¹

POWER CONSUMPTION

- +12 VDC, 2 A
- Isolated ELV power source

OPERATING ENVIRONMENT

- Operating temperature from 0 °C to +50 °C
- Operating humidity at 20% to 85% RH (non-condensing)
- Altitude up to 2000 meters
- Pollution Degree 2
- For indoor use only

STORAGE COMPLIANCE

- Storage temperature from -20 °C to 70 °C
- Storage humidity at 5% to 90% RH (non-condensing)

SAFETY COMPLIANCE

Certified with:

- IEC 61010-1:2001/EN 61010-1:2001 (2nd Edition)
- USA: UL61010-1: 2004
- Canada: CSA C22.2 No.61010-1:2004

EMC COMPLIANCE

- IEC 61326-1:2002/EN 61326-1:1998+A2:2001+A3:2003
- Canada: ICES-001:2004
- Australia/New Zealand: AS/NZS CISPR 11:2004

SHOCK AND VIBRATION

Tested to IEC/EN 60068-2

IO CONNECTOR

BNC connector

DIMENSION (W × D × H)

Module dimension:

- 117.00 mm × 180.00 mm × 41.00 mm (with bumpers)
- 105.00 mm × 175.00 mm × 25.00 mm (without bumpers)

WEIGHT

- 528 g (with bumpers)
- 476 g (without bumpers)

¹ Compatible with Microsoft Windows operating systems only.

*If remote connections are necessary, a E5813A USB/LAN hub can be used. Please go to the product's user guide for more information.

Product specifications and measurement characteristics

Waveforms			
Standard	Sine, Square, Ramp, Triangle, Pulse, DC		
Built-in arbitrary	Exponential Rise, Exponential Fall, Negative Ramp		
Waveform characteristics			
Sine			
Frequency range	1 μ Hz to 20 MHz (1 μ Hz resolution)		
Amplitude flatness ¹ (relative to 1 kHz)	< 100 kHz	0.2 dB	
	100 kHz to 1 MHz	0.35 dB	
	1 MHz to 20 MHz	0.7 dB	
Harmonic distortion ²	Frequency range	< 1 Vpp	\geq 1 Vpp
	DC to 20 kHz	-70 dBc	-60 dBc
	20 kHz to 100 kHz	-65 dBc	-60 dBc
	100 kHz to 1 MHz	-50 dBc	-45 dBc
	1 MHz to 20 MHz	-40 dBc	-35 dBc
	Total harmonic distortion ²	DC to 20 kHz	0.10%
Spurious (Non-harmonic) output ³	DC to 1 MHz	-65 dBc	
	1 MHz to 20 MHz	-65 dBc + 6 dB/octave	
Phase noise (10 kHz offset)	-115 dBc/Hz (Typical)		
Square			
Frequency range	1 μ Hz to 20 MHz (1 μ Hz resolution)		
Rise/Fall time	< 18 ns, 10 to 90% terminated load (50 W)		
Overshoot	< 2%		
Variable duty cycle	20% to 80% (up to 10 MHz)		
	40% to 60% (up to 20 MHz)		
Asymmetry (@ 50% duty)	1% of period + 5 ns		
Jitter (RMS)	> 50 kHz = 1 ns + 100 ppm of period		
	\leq 50 kHz = 10 ns + 100 ppm of period		
Ramp, Triangle			
Frequency range	1 μ Hz to 200 kHz (1 μ Hz resolution)		
Linearity	< 0.2% of peak output		
Programmable symmetry	0% to 100%		
Pulse			
Frequency range	500 μ Hz to 5 MHz (1 μ Hz resolution)		
Pulse width (period \leq 10 s)	40 ns minimum, 10 ns resolution		
Overshoot	< 3%		
Jitter (RMS)	300 ps + 0.1 ppm of period		

¹ Add 1/10th of output amplitude and offset specification per °C for operation outside the range of 18 °C to 28 °C.

² DC offset set to 0 V.

³ Spurious output at low amplitude is -70 dBm, typical.

Waveform characteristics (continued)	
Arbitrary	
Frequency range	1 μ Hz to 200 kHz (1 μ Hz resolution)
Waveform memory depth	64 kSa ¹
Amplitude resolution	14 bits/sample (including sign)
Sampling rate	50 MSa/s
Minimum rise/fall time	36 ns (Typical)
Linearity	< 0.2% of peak output
Settling Time	< 250 ns to 0.5% of final value
Jitter (RMS)	10 ns + 30 ppm
Common characteristics	
Amplitude	
Range	40 mVpp to 5 Vpp (Into 50 Ω load) 80 mVpp to 10 Vpp (Into open circuit)
Accuracy ² (across 50 Ω load at 1 kHz)	$\pm 1\%$ of setting ± 5 mV (± 10 mV @ Hi-Z)
Units	Vpp, Vrms, dBm
Resolution	4 digits
DC offset	
Range (peak AC + DC)	± 2.5 V (Into 50 Ω load) ± 5 V (Into open circuit)
Accuracy ² (across 50 Ω load)	$\pm 2\%$ of offset setting $\pm 1\%$ of amplitude ± 5 mV (± 10 mV @ Hi-Z)
Amplitude Limit	Amplitude + Offset limit to within ± 2.5 V range across 50 Ω load or ± 5 V across open circuit
Main output	
Impedance	50 Ω load (Typical)
Isolation	At least 42 Vpk to earth
Protection	Short-circuit protected, overload automatically disables main output
Internal frequency reference	
Accuracy ³	± 8 ppm in 1 year
External frequency reference	
Input	
– Lock range	10 MHz ± 170 Hz
– Amplitude level	500 mVpp to 5 Vpp
– Impedance	50 Ω AC coupled
– Lock time	< 2 s
Output	
– Frequency	10 MHz
– Amplitude Level	632 mVpp (Typical)
– Impedance	Return loss 10 dB (Typical) at 10 MHz
Phase Offset	
– Range	+360° to -360°
– Resolution	0.01°
– Accuracy	20 ns

¹ Maximum at 16 k points for Arbitrary waveforms when using bundled software, Keysight Measurement Manager (KMM) and 64 k points when programmed in compatible application development environments like Keysight VEE, NI LabVIEW, and Microsoft Visual Studio.

² Add 1/10th of output amplitude and offset specification per °C for operation outside the range of 18 °C to 28 °C.

³ Add 1 ppm/°C (average) for operation outside the range of 18 °C to 28 °C.

Trigger characteristics	
Trigger input	
Input Level	TTL compatible
Slope	Rising and Falling, Selectable
Pulse width	> 100 ns
Input impedance	> 10 k Ω , DC coupled
Latency	< 500 ns
Jitter (RMS)	6 ns (3.5 ns for pulse)
Trigger output	
Output Level	TTL compatible into ≥ 1 k Ω
Pulse width	> 400 ns
Output impedance	50 Ω (Typical)
Fanout	4 TTL
Rise time	≤ 20 ns
Modulation	
Modulation scheme	Internal, AM, FM, PM, FSK, PSK, ASK
AM	
Carrier waveforms	Sine, Square, Ramp, Arbitrary
Source	Internal
Internal modulation	Sine, Square, Ramp, Arbitrary (2 mHz to 20 kHz)
Depth	0.0% to 100.0%
FM	
Carrier waveforms	Sine, Square, Ramp, Arbitrary
Source	Internal
Internal modulation	Sine, Square, Ramp, Arbitrary (2 mHz to 20 kHz)
Deviation	1 Hz to 500 kHz
PM	
Carrier waveforms	Sine, Square, Ramp, Arbitrary
Source	Internal
Internal modulation	Sine, Square, Ramp, Arbitrary (2 mHz to 20 kHz)
Deviation	0.0° to 360.0°
FSK	
Carrier waveforms	Sine, Square, Ramp, Arbitrary
Source	Internal
Internal modulation	50% duty cycle square (2 mHz to 100 kHz)
PSK	
Carrier waveforms	Sine, Square, Ramp, Arbitrary
Source	Internal
Internal modulation	50% duty cycle square (2 mHz to 100 kHz)
Deviation	0.0° to 360.0°
ASK	
Carrier waveforms	Sine, Square, Ramp, Arbitrary
Source	Internal
Internal modulation	50% duty cycle square (2 mHz to 100 kHz)

Sweep Characteristics

Waveforms	Sine, Square, Ramp, Arbitrary
Type	Linear or Logarithmic
Direction	Up or Down
Sweep time	1 ms to 500 s
Trigger	Single, External, or Internal

Ordering Information

The table below list out the models and the respective optional accessories.

For more information, please visit our web site or contact your local Keysight office. The complete list is available at www.keysight.com/find/contactus.

Part number	Description
U2781A USB modular product chassis	
U2905A	Rackmount kit
U2300A Series USB modular multifunction DAQ	
U2331A	U2300A Series USB modular multifunction DAQ
U2351A	U2300A Series USB modular multifunction DAQ
U2352A	U2300A Series USB modular multifunction DAQ
U2353A	U2300A Series USB modular multifunction DAQ
U2354A	U2300A Series USB modular multifunction DAQ
U2355A	U2300A Series USB modular multifunction DAQ
U2356A	U2300A Series USB modular multifunction DAQ
U2802A	U2802A 31-Channel Thermocouple Input Device
U2901A	Terminal block and SCSI-II 68-pin connector with 1-meter cable
U2902A	Terminal block and SCSI-II 68-pin connector with 2-meter cable
U2500A Series USB modular simultaneous sampling multifunction DAQ	
U2541A	U2500A Series USB modular simultaneous sampling multifunction DAQ
U2542A	U2500A Series USB modular simultaneous sampling multifunction DAQ
U2531A	U2500A Series USB modular simultaneous sampling multifunction DAQ
U2901A	Terminal block and SCSI-II 68-pin connector with 1-meter cable
U2902A	Terminal block and SCSI-II 68-pin connector with 2-meter cable
U2600A Series USB modular isolated digital I/O	
U2651A	U2600A Series USB modular isolated digital I/O
U2652A	U2600A Series USB modular isolated digital I/O
U2653A	U2600A Series USB modular isolated digital I/O
U2903A	Terminal block and SCSI-II 100-pin connector with 1-meter cable
U2904A	Terminal block and SCSI-II 100-pin connector with 2-meter cable

Part number	Description
U2701A USB modular oscilloscope (100 MHz)/U2702A USB modular oscilloscope (200 MHz)	
N2862A	10:1 passive probe 150 MHz 1.2 m (for U2701A)
N2863A	10:1 passive probe 300 MHz 1.2 m (for U2702A)
U2701A-200	10070C 1:1 passive probe 20 MHz 1.5 m
U2921A-101	USB secure cable 2 m
U2921A-100	BNC cable
U2722A/U2723A USB modular source measure unit	
U2921A-101	USB secure cable 2 m
U2741A USB modular digital multimeter	
34138A	Test lead set
E2308A	Thermistor temperature probe
U2921A-101	USB secure cable 2 m
U2751A USB modular switch matrix	
U2922A-201	32-channel terminal block
U2921A-101	USB secure cable 2 m
U2761A USB modular function/arbitrary generator	
U2921A-101	USB secure cable 2 m
U2921A-100	BNC cable
U2010A	Arbitrary waveform generation upgrade to 2 MHz
U2010A-1FP	Arbitrary waveform generation upgrade bundle purchase with U2761A

Evolving Since 1939

Our unique combination of hardware, software, services, and people can help you reach your next breakthrough. We are unlocking the future of technology.
 From Hewlett-Packard to Agilent to Keysight.

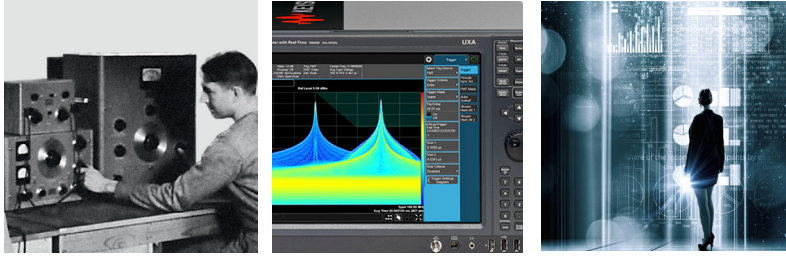

For more information on Keysight Technologies' products, applications or services, please contact your local Keysight office. The complete list is available at: www.keysight.com/find/contactus

Americas

Canada	(877) 894 4414
Brazil	55 11 3351 7010
Mexico	001 800 254 2440
United States	(800) 829 4444

Asia Pacific

Australia	1 800 629 485
China	800 810 0189
Hong Kong	800 938 693
India	1 800 11 2626
Japan	0120 (421) 345
Korea	080 769 0800
Malaysia	1 800 888 848
Singapore	1 800 375 8100
Taiwan	0800 047 866
Other AP Countries	(65) 6375 8100

Europe & Middle East

Austria	0800 001122
Belgium	0800 58580
Finland	0800 523252
France	0805 980333
Germany	0800 6270999
Ireland	1800 832700
Israel	1 809 343051
Italy	800 599100
Luxembourg	+32 800 58580
Netherlands	0800 0233200
Russia	8800 5009286
Spain	800 000154
Sweden	0200 882255
Switzerland	0800 805353
	Opt. 1 (DE)
	Opt. 2 (FR)
	Opt. 3 (IT)
United Kingdom	0800 0260637

For other unlisted countries:
www.keysight.com/find/contactus
 (BP-9-7-17)



www.keysight.com/go/quality
 Keysight Technologies, Inc.
 DEKRA Certified ISO 9001:2015
 Quality Management System

myKeysight

myKeysight

www.keysight.com/find/mykeysight

A personalized view into the information most relevant to you.

http://www.keysight.com/find/emt_product_registration

Register your products to get up-to-date product information and find warranty information.

KEYSIGHT SERVICES

Accelerate Technology Adoption.
 Lower costs.

Keysight Services

www.keysight.com/find/service

Keysight Services can help from acquisition to renewal across your instrument's lifecycle. Our comprehensive service offerings—one-stop calibration, repair, asset management, technology refresh, consulting, training and more—helps you improve product quality and lower costs.



Keysight Assurance Plans

www.keysight.com/find/AssurancePlans

Up to ten years of protection and no budgetary surprises to ensure your instruments are operating to specification, so you can rely on accurate measurements.

Keysight Channel Partners

www.keysight.com/find/channelpartners

Get the best of both worlds: Keysight's measurement expertise and product breadth, combined with channel partner convenience.

www.keysight.com/find/usbmodular

