

# 2450-EC Graphical Potentiostat

## Datasheet



The 2450-EC Graphical Potentiostat brings speed, flexibility, and simplicity right to your fingertips. Its innovative graphical user interface (GUI) and advanced, capacitive touchscreen technology allow intuitive usage and minimize the learning curve to enable researchers, scientists, and students to learn faster, work smarter, and invent easier. The 2450-EC is a versatile instrument, particularly well-suited for research and development in fundamental electrochemical lab research, characterizing the next generation of materials and electrolytes, new energy storage devices, and faster, smaller sensors.

### Key Features

- Perform Cyclic, Squarewave, or Galvanic Voltammetry, Chronoamperometry, and Chronopotentiometry
- Simplified user interface for faster test setup and analysis of results
- Real-time plotting of voltammograms on the front panel
- Analytical graph cursors for immediate analysis of results without the need for a PC
- Create libraries of reusable, customizable experimental software with built-in scripting
- Screen capture function allows copying test results from the display to reports
- 10 nV and 10 fA measurement sensitivity
- Front panel input banana jacks; rear panel input triaxial connections
- Context-sensitive help function minimizes learning
- Front-panel USB 2.0 memory I/O port for transferring data, test scripts, or test configurations

While potentiostats are excellent instruments for electrochemistry applications, they typically lack any front panel display and control knobs, often are 2-quadrant systems only, and must be completely controlled by a computer with software that is not always open for users to customize tests beyond what the software can do.

The 2450-EC includes a wide range of voltages and currents for sourcing or measuring, nV / fA sensitivities, and high impedance sense leads with a typical input resistance of 50 G ohms and only 1pA of input bias current, typically acceptable with a wide variety of reference electrodes. The 2450-EC can run internal application test scripts so electrochemistry measurements can be run without the use of an external computer. Results are immediately displayed right on the instrument front panel touchscreen. Connecting the 2450-EC to a 2-, 3-, or 4-electrode cell is simple with the included translation cable.

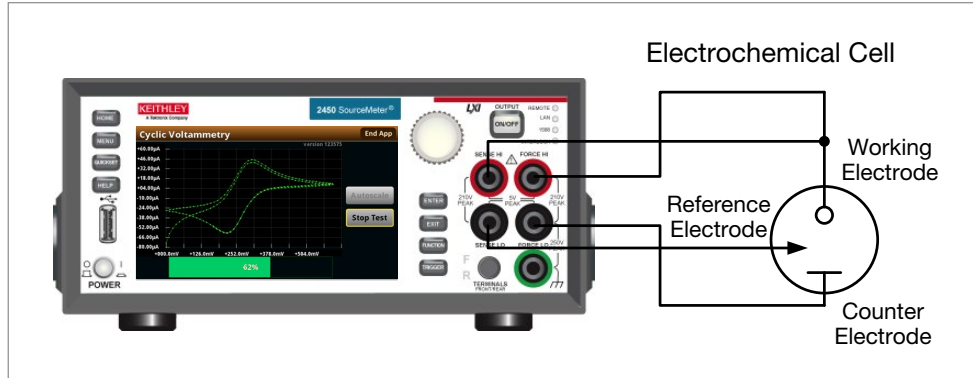

The 2450-EC can be easily connected to a 3-electrode cell.

## Learn Faster; Work Smarter; Invent Easier

Unlike traditional potentiostats that lack a user-interface front panel to interact with, the 2450-EC features a five-inch, full-color, high resolution touchscreen that facilitates ease of use, and optimizes overall speed and productivity. Built-in, context-sensitive help enables intuitive operation and minimizes the need to review a separate manual. These capabilities combined with its application versatility make the 2450-EC inherently easy to use for basic and advanced measurement applications, regardless of your experience level with electrochemistry instruments.

## Convert Raw Data into Information

A full graphical plotting window converts raw data and displays it immediately as useful information, such as cyclic voltammograms. The touch screen interface makes it easy to observe, interact with, and explore measurements with “zoom and pinch” simplicity. By using the built-in graphing cursors, you can immediately analyze your data without a computer. All graphic screens can be saved to a USB thumb drive for incorporation into reports and journals. Using the graphical sheet view, test data can also be displayed in tabular form. The instrument supports exporting data to a spreadsheet for further analysis, dramatically improving productivity for research and development. This combination of high performance and high ease of use offers unparalleled insight into your test results.

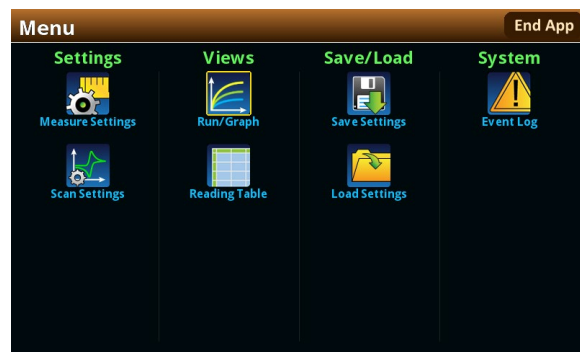

2450-EC Cyclic Voltammetry Menu



2450-EC Cyclic Voltammetry Test Configuration Screen

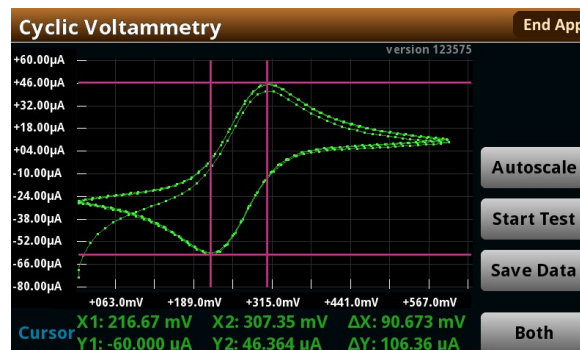

Graph view of results

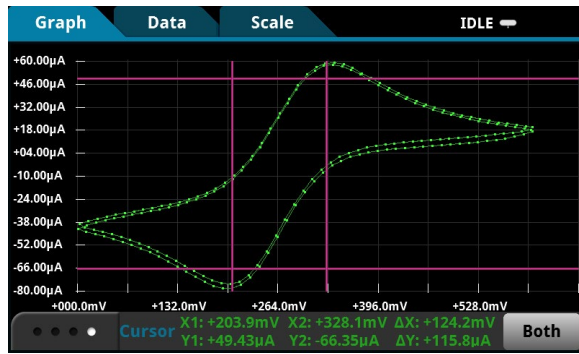

Built-in real-time graphing, charting, scope-like cursors, and data display spreadsheet for export simplifies converting test results into useful information.

Buffer Index	Time	Reading	Source
1	10/25 13:35:32.968686	-0.07454 mA	+0.000000 V
2	10/25 13:35:33.229296	-0.06051 mA	+0.012000 V
3	10/25 13:35:33.469267	-0.05294 mA	+0.024000 V
4	10/25 13:35:33.709260	-0.04764 mA	+0.036000 V
5	10/25 13:35:33.949270	-0.04370 mA	+0.048000 V
6	10/25 13:35:34.209295	-0.04034 mA	+0.061000 V
7	10/25 13:35:34.449267	-0.03782 mA	+0.073000 V
8	10/25 13:35:34.689266	-0.03567 mA	+0.085000 V
9	10/25 13:35:34.929289	-0.03377 mA	+0.097000 V
10	10/25 13:35:35.189288	-0.03191 mA	+0.110000 V

## Test Applications

The 2450-EC's built-in scripting language enables electrochemists, chemists, and materials scientists to create libraries of reusable, customizable experimental software for running tests including cyclic voltammetry, chronoamperometry, chronopotentiometry, and more. The following electrochemistry test scripts are loaded in the internal memory of the 2450-EC.

- **Cyclic Voltammetry:** Potential is swept at a user programmable scan rate between two to four defined vertices while current is measured. Current is measured using an analog integration method. This application can also be used to perform Linear Sweep Voltammetry.
- **Open Circuit Potential:** Measures the cell potential difference between two electrodes with high input impedance as a function of time.
- **Potential Pulse and Square Wave with Current Measure:** The 2450-EC sources potential at programmable peak and base levels and the resulting current is recorded at the pulse peak level.
- **Current Pulse and Square Wave with Voltage Measure:** The 2450-EC sources current at programmable peak and base levels and the resulting potential is recorded at the pulse peak level.
- **Chronoamperometry:** The potential is stepped to a programmed value and the resulting current is measured as a function of time.
- **Chronopotentiometry:** The current is stepped to a programmed value and the resulting potential is measured as a function of time.

In addition to pre-loaded test scripts, the built-in scripting language enables the user to create their own library of electrochemistry test scripts that can be modified as the test and measurements evolve.

## Typical Applications

Ideal for electrochemical research and development in a wide variety of applications studies, including:

- Basic Analytical Research
  - Electrochemical cells
  - Electrode studies
  - Solid electrolytes
- Materials Research
  - Electrode compositions
  - Electrolyte solutions
  - Ceramics, polymers, ferro/ piezoelectrics
  - Organic semiconductors
  - Low-k dielectrics
  - Biomaterials
  - Nanomaterials
  - Electrodesposition
- Energy Systems and Storage
  - Dye-sensitized solar cells
  - Batteries
  - Fuel cells, flow batteries
  - Supercapacitors
- Sensors
  - Environmental monitoring
  - Industrial process control
  - Healthcare/medical

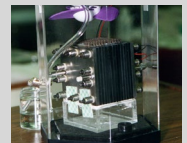
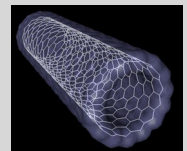

## All-in-One Instrument

The 2450-EC offers a highly flexible, four-quadrant voltage and current source/load coupled with precision voltage and current meters. When not used in potentiostat type applications, this all-in one instrument can be repurposed as a general lab instrument, including use as a:

- Precision power supply with V and I readback
- True current source
- Digital multimeter (DCV, DCI, ohms, and power with 6½-digit resolution)
- Precision electronic load
- Trigger controller

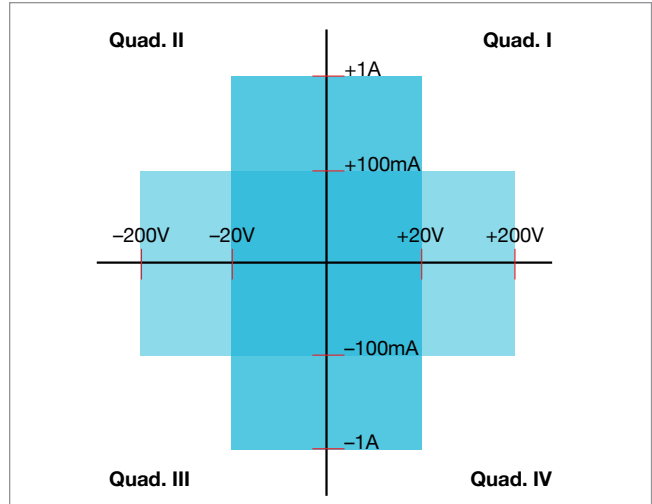

2450-EC power envelope.

## Ease of Use Beyond the Touchscreen

In addition to its five-inch, color touchscreen, the 2450-EC front panel has many features that supplement its speed, user-friendliness, and learnability, including a USB 2.0 memory I/O port, a HELP key, a rotary navigation/control knob, a front/rear input selector button, and banana jacks for basic bench applications. The USB 2.0 memory port supports easy data storing, saving instrument configurations, loading test scripts, and system upgrades. Plus, all front panel buttons are backlit to enhance visibility in low-light environments.

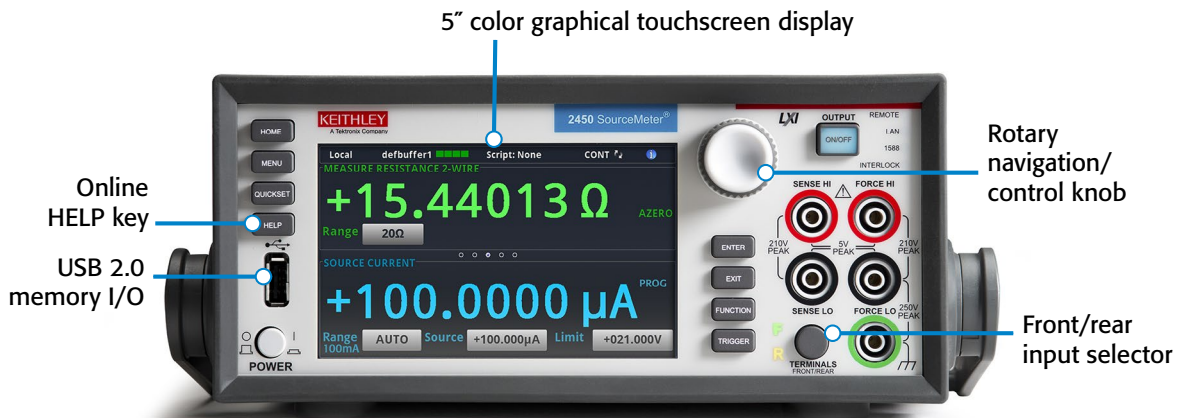

2450-EC front panel with high-resolution, capacitive touchscreen.

## Comprehensive Built-in Connectivity

Rear panel access to rear-input triax connectors, remote control interfaces (GPIB, USB 2.0, and LXI/Ethernet), D-sub 9-pin digital I/O port (for internal/external trigger signals and handler control), instrument interlock control, and TSP-Link® jacks enables easy configuration of multiple instrument test solutions and eliminates the need to invest in additional adapter accessories.

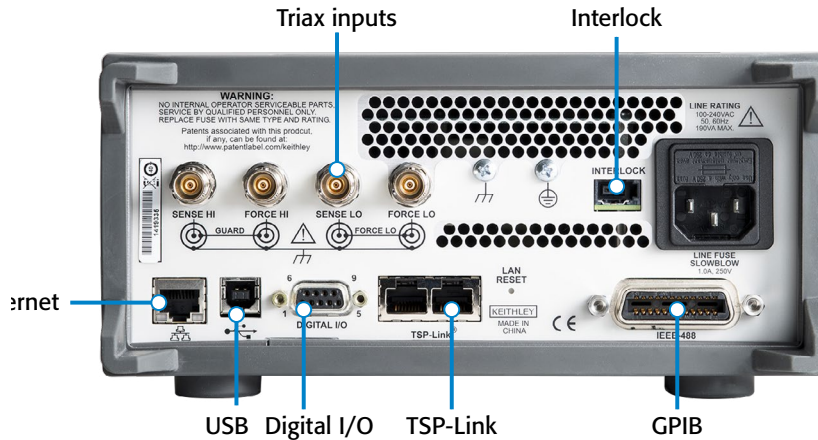

Rear panel connections are optimized for signal integrity.

## Free Instrument Control Start-up Software

The 2450-EC can be repurposed for applications beyond electrochemistry as a general purpose lab tool, e.g. I-V testing, leakage testing, battery charge/discharge profiling, etc. KickStart, Keithley's instrument control non-programming start-up software, lets users start taking measurements in minutes for typical current versus voltage applications. In most cases, users merely need to make quick measurements, graph the data, and store the data to disk to perform analysis in software environments such as Excel.

KickStart offers the following functionality:

- Instrument configuration control to perform I-V characterization

- Native X-Y graphing, panning, and zooming
- Spreadsheet/tabular viewing of data
- Saving and exporting data for further analysis
- Saving of test setups
- Screenshot capturing of graph
- Annotation of tests
- Command line dialog for sending and receiving data
- HTML help
- GPIB, USB 2.0, Ethernet compliant

## Simplified Programming with Ready-to-Use Instrument Drivers

For those who prefer to create their own customized application software, native National Instruments LabVIEW® drivers, as well as IVI-C and IVI-COM drivers are available at [www.tektronix.com](http://www.tektronix.com).

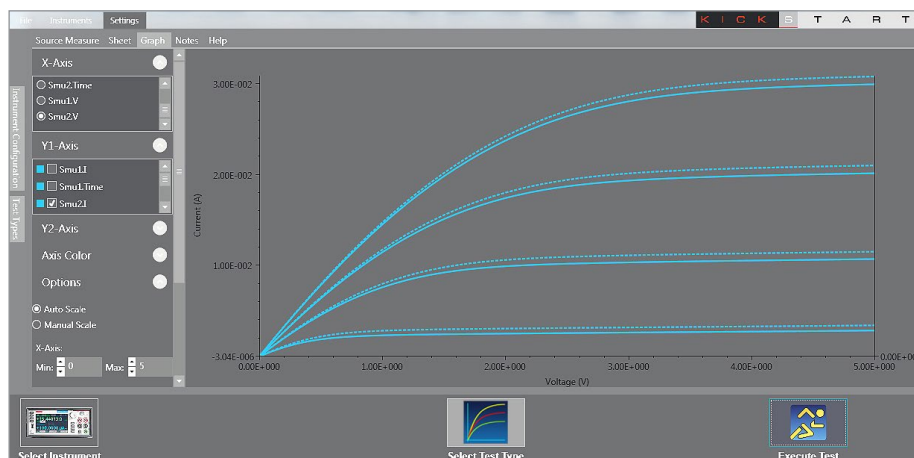

With KickStart start-up software, users are ready to take measurements in minutes.



## Test Script Specifications

---

### 2450-EC Cyclic Voltammetry Specifications

Potential Range	$-20\text{ V} \leq E \leq +20\text{ V}$
Current Measure Ranges	10 $\mu\text{A}$ , 100 $\mu\text{A}$ , 1 mA, 10 mA, 100 mA, 1 A
Source Limit (Compliance)	100% of selected current range
Scan Rate	0.1 mV/s to 3500 mV/s
Potential Step Size During Scanning	100 $\mu\text{V}$ (0.1 mV/s $\leq$ scan rate < 35 mV/s) 1 mV (35 mV/s $\leq$ scan rate < 350 mV/s ) 10 mV (350 mV/s $\leq$ scan rate $\leq$ 3500 mV/s)
Number of Cycles	1 to 100
User Selectable Sampling Intervals	Points/Test (10 to 10000) Points/Cycle (10 to 10000) Seconds/Point (0.01 to 100) Points/Second (0.01 to 100)
Maximum Total Number of Samples	100,000

---

### 2450-EC Open Circuit Potential Specifications

Potential Measure Ranges	20 mV, 200 mV, 2 V, 20 V
Sample Interval	0.75 s $\leq$ sample interval $\leq$ 100 s
Number of Samples	1 to 100,000

---

### 2450-EC Potential Pulse and Square Wave Specifications

Peak Potential	$-20\text{ V} \leq E_{\text{peak}} \leq +20\text{ V}$
Base Potential	$-20\text{ V} \leq E_{\text{base}} \leq +20\text{ V}$
Current Measure Ranges	1 $\mu\text{A}$ , 10 $\mu\text{A}$ , 100 $\mu\text{A}$ , 1 mA, 10 mA, 100 mA, 1 A
Source Limit (Compliance)	105% of selected current range
Pulse Period and Width	<p><b>Current Measure Range = 1 <math>\mu\text{A}</math></b>                  200 ms <math>\leq</math> period <math>\leq</math> 3600 s                  100 ms <math>\leq</math> pulse width <math>\leq</math> (0.99 <math>\times</math> period)</p> <p><b>Current Measure Range &gt; 1 <math>\mu\text{A}</math></b>                  4 ms <math>\leq</math> period <math>\leq</math> 3600 s                  2ms <math>\leq</math> pulse width <math>\leq</math> (0.99 <math>\times</math> period)</p>
Sample Time	Minimum is 166.667 $\mu\text{s}$ . Maximum is lesser of 166.667 ms and (pulse width – 1 ms)
Number of Cycles	1 to 100,000
Program Time	(1 $\times$ period) $\leq$ program time $\leq$ (100,000 $\times$ period)

## 2450-EC Current Pulse and Square Wave Specifications

Peak Current	$-1.05 \text{ A} \leq I_{\text{peak}} \leq +1.05 \text{ A}$
Base Current	$-1.05 \text{ A} \leq I_{\text{base}} \leq +1.05 \text{ A}$
Potential Measure Ranges	20 mV, 200 mV, 2 V, 20 V
Source Limit (Compliance)	105% of selected potential range
<b>Pulse Period and Width</b>	
$I_{\text{peak}} \text{ and } I_{\text{base}} \leq 1.05 \mu\text{A}$	200 ms $\leq$ period $\leq$ 3600 s 100 ms $\leq$ pulse width $\leq$ (0.99 $\times$ period)
$I_{\text{peak}} \text{ or } I_{\text{base}} > 1.05 \mu\text{A}$	4 ms $\leq$ period $\leq$ 3600 s 2 ms $\leq$ pulse width $\leq$ (0.99 $\times$ period)
Sample Time	Minimum is 166.667 $\mu\text{s}$ . Maximum is lesser of 166.667 ms and (pulse width – 1 ms)
Number of Cycles	1 to 100,000
Program Time	(1 $\times$ period) $\leq$ program time $\leq$ (100,000 $\times$ period)

## 2450-EC Chronoamperometry Specifications

Step Potential	$-20 \text{ V} \leq E_{\text{step}} \leq +20 \text{ V}$
Current Measure Ranges	10 nA, 100 nA, 1 $\mu\text{A}$ , 10 $\mu\text{A}$ , 100 $\mu\text{A}$ , 1 mA, 10 mA, 100 mA, 1 A
Source Limit (Compliance)	100% of selected current range
Number of Steps	1 to 10
Step Duration	10 ms $\leq$ step duration $\leq$ 99,999 s
Sample Interval	10 ms $\leq$ sample interval $\leq$ 100 s
Sample Time	Minimum is 166.667 $\mu\text{s}$ . Maximum is lesser of 166.667 ms and (sample interval – 5 ms) and (step duration – 5 ms)
Maximum Number of Samples	100,000 total for all steps

## 2450-EC Chronopotentiometry Specifications

Step Current	$-1.05 \text{ A} \leq I_{\text{step}} \leq +1.05 \text{ A}$
Potential Measure Ranges	20 mV, 200 mV, 2 V, 20 V
Source Limit (Compliance)	100% of selected potential range
Number of Steps	1 to 10
Step Duration	10 ms $\leq$ step duration $\leq$ 99,999 s
Sample Interval	10 ms $\leq$ sample interval $\leq$ 100 s
Sample Time	Minimum is 166.667 $\mu\text{s}$ . Maximum is lesser of 166.667 ms and (sample interval – 5 ms) and (step duration – 5 ms)
Maximum Number of Samples	100,000 total for all steps

## Specifications

### Voltage Specifications <sup>1, 2</sup>

Range	Source			Measure <sup>3</sup>		
	Resolution	Accuracy (23° ± 5°C) 1 Year ±(% setting + volts)	Noise (RMS) (<10 Hz)	Resolution	Input Resistance	Accuracy (23° ± 5°C) 1 Year ±(% rdg. + volts)
20.00000 mV	500 nV	0.100% + 200 µV	1 µV	10 nV	>10 GΩ	0.100% + 150 µV
200.0000 mV	5 µV	0.015% + 200 µV	1 µV	100 nV	>10 GΩ	0.012% + 200 µV
2.000000 V	50 µV	0.020% + 300 µV	10 µV	1 µV	>10 GΩ	0.012% + 300 µV
20.00000 V	500 µV	0.015% + 2.4 mV	100 µV	10 µV	>10 GΩ	0.015% + 1 mV
200.0000 V	5 mV	0.015% + 24 mV	1 mV	100 µV	>10 GΩ	0.015% + 10 mV

### Current Specifications <sup>1, 2</sup>

Range	Source			Measure <sup>3</sup>		
	Resolution	Accuracy (23° ± 5°C) <sup>4</sup> 1 Year ±(% setting + amps)	Noise (RMS) (<10 Hz)	Resolution	Voltage Burden	Accuracy (23° ± 5°C) 1 Year ±(% rdg. + amps)
10.00000 nA <sup>5</sup>	500 fA	0.100% + 100 pA	500 fA	10 fA	<100 µV	0.100% + 50 pA
100.0000 nA <sup>5</sup>	5 pA	0.060% + 150 pA	500 fA	100 fA	<100 µV	0.060% + 100 pA
1.000000 µA	50 pA	0.025% + 400 pA	5 pA	1 pA	<100 µV	0.025% + 300 pA
10.00000 µA	500 pA	0.025% + 1.5 nA	40 pA	10 pA	<100 µV	0.025% + 700 pA
100.0000 µA	5 nA	0.020% + 15 nA	400 pA	100 pA	<100 µV	0.020% + 6 nA
1.000000 mA	50 nA	0.020% + 150 nA	5 nA	1 nA	<100 µV	0.020% + 60 nA
10.00000 mA	500 nA	0.020% + 1.5 µA	40 nA	10 nA	<100 µV	0.020% + 600 nA
100.0000 mA	5 µA	0.025% + 15 µA	100 nA	100 nA	<100 µV	0.025% + 6 µA
1.000000 A	50 µA	0.067% + 900 µA	3 µA	1 µA	<100 µV	0.030% + 500 µA

#### Temperature Coefficient (0°–18°C and 28°–50°C)

±(0.15 × accuracy specification)/°C.

#### Notes

- Speed = 1 PLC.
- All specifications are guaranteed with output ON.
- Accuracies apply to 2- and 4-wire mode when properly zeroed.
- For sink mode, 1 µA to 100 mA range accuracy is ±(0.15% + offset × 4). For 1A range, accuracy is ±(1.5% + offset × 8).
- Rear panel triax connections only.



## Resistance Measurement Accuracy (Local or Remote Sense) <sup>1, 2</sup>

Range	Default Resolution <sup>3</sup>	Default Test Current	Normal Accuracy (23°C ±5°C) 1 Year, ±(% rdg. + ohms)	Enhanced Accuracy <sup>4</sup> (23°C ±5°C) 1 Year, ±(% rdg. + ohms)
<2.000000 Ω <sup>5</sup>	1 μΩ	User defined	Source I <sub>ACC</sub> + Meas. V <sub>ACC</sub>	Meas. I <sub>ACC</sub> + Meas. V <sub>ACC</sub>
20.00000 Ω	10 μΩ	100 mA	0.098% + 0.003 Ω	0.073% + 0.001 Ω
200.0000 Ω	100 μΩ	10 mA	0.077% + 0.03 Ω	0.053% + 0.01 Ω
2.000000 kΩ	1 mΩ	1 mA	0.066% + 0.3 Ω	0.045% + 0.1 Ω
20.00000 kΩ	10 mΩ	100 μA	0.063% + 3 Ω	0.043% + 1 Ω
200.0000 kΩ	100 mΩ	10 μA	0.065% + 30 Ω	0.046% + 10 Ω
2.000000 MΩ	1 Ω	1 μA	0.110% + 300 Ω	0.049% + 100 Ω
20.00000 MΩ	10 Ω	1 μA	0.110% + 1 kΩ	0.052% + 500 Ω
200.0000 MΩ	100 Ω	100 nA	0.655% + 10 kΩ	0.349% + 5k Ω
>200.0000 MΩ <sup>5</sup>	—	User defined	Source I <sub>ACC</sub> + Meas. V <sub>ACC</sub>	Meas. I <sub>ACC</sub> + Meas. V <sub>ACC</sub>

### Temperature Coefficient, (0°–18°C and 28°–50°C)

±(0.15 × accuracy specification)/°C.

### Source Current, Measure Resistance Mode

Total uncertainty = I<sub>source</sub> accuracy + V<sub>measure</sub> accuracy (4-wire remote sense).

### Source Voltage, Measure Resistance Mode

Total uncertainty = V<sub>source</sub> accuracy + I<sub>measure</sub> accuracy (4-wire remote sense).

### Guard Output Impedance

0.5 Ω (DC) in ohms mode.

### Notes

- All specifications are guaranteed with output ON.
- Accuracies apply to 2- and 4-wire mode when properly zeroed.
- 6.5 digit measure resolution
- Source readback enabled. Offset compensation ON.
- Source Current, Measure Resistance or Source Voltage, Measure Resistance only. For best measurements, use rear panel triax connectors.

## Operating Characteristics

Max. Output Power	20 W, four-quadrant source or sink operation.
Source Limits	<b>Vsource:</b> ±21 V (≤ 1 A range), ±210 V (≤ 100 mA range) <b>Isource:</b> ±1.05 A (≤ 20 V range), ±105 mA (≤ 200 V range).
Overrange	105% of range, source and measure.
Regulation	<b>Voltage:</b> Line: 0.01% of range. <b>Load:</b> 0.01% of range + 100 μV. <b>Current:</b> Line: 0.01% of range. <b>Load:</b> 0.01% of range + 100 pA.
Source Limits	<b>Voltage Source Current Limit:</b> Bipolar current limit set with single value. Min. 10% of range. <b>Current Source Voltage Limit:</b> Bipolar voltage limit set with single value. Min. 10% of range.
V-Limit / I-Limit Accuracy	Add 0.3% of setting and ±0.02% of reading to base specification.
Overshoot	<b>Voltage Source:</b> <0.1% typical (full scale step, resistive load, 20 V range, 10 mA I-Limit). <b>Current Source:</b> <0.1% typical (1 mA step, R <sub>Load</sub> = 10 kΩ, 20 V range).
Range Change Overshoot	Overshoot into a fully resistive 100 kΩ load, 10 Hz to 20 MHz BW, adjacent ranges: 250 mV typical
Output Settling Time	Time required to reach 0.1% of final value, 20 V range, 100 mA I-Limit: <200 μs typical.
Maximum Slew Rate	0.2 V/μs, 200 V range, 100 mA limit into a 2 kΩ load (typical).
Over Voltage Protection	User selectable values, 5% tolerance. Factory default = none.
Voltage Source Noise	10 Hz–1 MHz (RMS): 2 mV typical into a resistive load.
Common Mode Voltage	250 V DC.

**Common Mode Isolation** >1 GΩ, <1000 pF.

**Noise Rejection (typical)**

NPLC	NMRR	CMRR
0.01	—	60 dB
0.1	—	60 dB
1	60 dB	100 dB*

\* Except lowest two current ranges -90dB.

**Load Impedance** 20 nF typical (standard). Stable into 50 μF typical (High-C mode). High-C mode valid for ≥100 μA ranges, ≥200 mV ranges.

**Max. Voltage Drop Between Force and Sense Terminals** 5 V.

**Max. Sense Lead Resistance** 1 MΩ for rated accuracy.

**Sense Input Impedance** >10 GΩ.

**Guard Offset Voltage** <300 μV, typical

**System Measurement Speeds <sup>1</sup>**

**Reading Rates (readings/second) typical for 60 Hz (50 Hz):**

**Script (TSP) Programmed**

NPLC/Trigger Origin	Measure				Source-Measure Sweep			
	To Mem.	To GPIB	To USB	To LAN	To Mem.	To GPIB	To USB	To LAN
0.01 / Internal	3130 (2800)	2830 (2570)	2825 (2600)	2790 (2530)	1710 (1620)	1620 (1540)	1630 (1540)	1620 (1540)
0.01 / External	2170 (2050)	2150 (2030)	2170 (2040)	2160 (1990)	1670 (1590)	1580 (1500)	1590 (1510)	1580 (1510)
0.1 / Internal	540 (460)	530 (450)	530 (450)	530 (450)	470 (410)	460 (400)	470 (400)	470 (400)
0.1 / External	500 (430)	490 (420)	500 (430)	500 (420)	470 (400)	460 (390)	460 (400)	460 (400)
1.00 / Internal	59 (49)	58 (49)	59 (49)	59 (49)	58 (48)	58 (48)	58 (48)	58 (48)
1.00 / External	58 (48)	57 (48)	58 (48)	58 (48)	57 (48)	57 (47)	57 (48)	57 (48)

**SCPI Programmed <sup>2</sup>**

NPLC/Trigger Origin	Measure				Source-Measure Sweep			
	To Mem.	To GPIB	To USB	To LAN	To Mem.	To GPIB	To USB	To LAN
0.01 / Internal	3130 (2800)	3060 (2760)	3000 (2790)	3010 (2710)	1710 (1630)	1610 (1600)	1440 (1380)	1690 (1590)
0.01 / External	2350 (2200)	2320 (2170)	2340 (2190)	2320 (2130)	1680 (1590)	1560 (1570)	1410 (1360)	1660 (1560)
0.1 / Internal	540 (460)	540 (450)	540 (460)	540 (450)	470 (410)	470 (410)	450 (390)	470 (410)
0.1 / External	510 (440)	510 (430)	510 (440)	510 (430)	470 (400)	470 (400)	450 (390)	470 (400)
1.00 / Internal	59 (49)	59 (49)	59 (49)	59 (49)	58 (48)	58 (48)	57 (48)	58 (48)
1.00 / External	58 (49)	58 (49)	58 (49)	58 (49)	58 (48)	58 (48)	57 (47)	58 (48)

**Notes**

1. Reading rates applicable for voltage or current measurements, autozero off, autorange off, filter off, binary reading format, and source readback off.
2. SCPI programming mode. Speeds do not apply to SCPI 2400 mode.

## General Characteristics (default mode unless specified)

<b>Factory Default Standard Power-Up</b>	SCPI Mode.
<b>Source Output Modes</b>	Fixed DC Level, Memory/Configuration List (mixed function), Stair (linear and log).
<b>Source Memory List</b>	100 points max. (SCPI 2400 Mode only).
<b>Memory Buffer</b>	>250,000 readings. Includes selected measured value(s) and time stamp.
<b>Real-Time Clock</b>	Lithium battery backup (3 yr. + battery life).
<b>Remote Interfaces</b>	
<b> GPIB</b>	IEEE-488.1 compliant. Supports IEEE-488.2 common commands and status model topology.
<b> USB Device (rear panel, type B)</b>	2.0 Full Speed USBTMC.
<b> USB Host (front panel, type A)</b>	USB 2.0, support for flash drives, FAT32.
<b> Ethernet</b>	RJ-45 (10/100BT).
<b>Digital I/O Interface:</b>	
<b> Lines</b>	6 Input/Output user defined for digital I/O or triggering.
<b> Connector</b>	9-pin female D.
<b> Input Signal Levels</b>	0.7 V (maximum logic low), 3.7 V (minimum logic high).
<b> Input Voltage Limits</b>	-0.25 V (Abs. minimum), +5.25 V (Abs. maximum).
<b> Maximum Source Current</b>	+2.0 mA @ >2.7 V (per pin).
<b> Maximum Sink Current</b>	-50 mA @ 0.7 V (per pin, solid-state fuse protected).
<b> 5V Power Supply Pin</b>	Limited to 500 mA @ >4 V (solid-state fuse protected).
<b> Handler</b>	User definable Start of Test, End of Test, 4 category bits.
<b>Programmability</b>	SCPI or TSP command sets.
<b>TSP Mode</b>	Embedded Test Script Processor (TSP) accessible from any host interface.
<b>IP Configuration</b>	Static or DHCP.
<b>Expansion Interface</b>	The TSP-Link expansion interface allows TSP enabled instruments to trigger and communicate with each other.
<b>LXI Compliance</b>	1.4 LXI Core 2011.
<b>Display</b>	5 inch capacitive touch, color TFT WVGA (800×480) with LED backlight.
<b>Input Signal Connections</b>	<b>Front:</b> Banana. <b>Rear:</b> Triaxial (3-lug).
<b>Interlock</b>	Active High Input.
<b>Cooling</b>	Forced air, variable speed.
<b>Over Temperature Protection</b>	Internally sensed temperature overload puts unit in standby mode.
<b>Power Supply</b>	100 V to 240 V RMS, 50–60 Hz (automatically detected at power up).
<b>VA Rating</b>	190 volt-amps max.
<b>Altitude</b>	Maximum 2000 meters above sea level.
<b>EMC</b>	Conforms to European Union EMC Directive.
<b>Safety</b>	NRTL listed to UL61010-1 and UL61010-2-30. Conforms with European Union Low Voltage Directive.
<b>Vibration</b>	MIL-PRF-28800F Class 3 Random.

Warm-Up	1 hour to rated accuracies.
Dimensions	<b>With bumpers and handle:</b> 106 mm high × 255 mm wide × 425 mm deep (4.18 in × 10.05 in × 16.75 in). <b>Without bumpers and handle:</b> 88 mm high × 213 mm wide × 403 mm deep (3.46 in × 8.39 in × 15.87 in.)
Weight	<b>With bumpers and handle:</b> 4.04 kg (8.9 lbs.). <b>Without bumpers and handle:</b> 3.58 kg (7.9 lbs.).
Environment	<b>Operating:</b> 0°–50°C, 70% R.H. up to 35°C. Derate 3% R.H./°C, 35°–50°C. <b>Storage:</b> –25°C to 65°C.

## Supplied Accessories

### Electrochemistry Translation Cable Accessory Kit

8608	High Performance Test Leads
CA-180-3A	TSP-Link/Ethernet Cable
CS-1616-3	Safety Interlock Mating Connector
USB-B-1	USB Cable, Type A to Type B, 1m (3.3 ft)

### Documentation CD

### Application Test Scripts and Documentation on USB Flash Drive

### SMU Potentiostats and EC-Upgrade Kit

### Quick Start Guide

Test Script Builder Software	(available at <a href="http://www.tektronix.com">www.tektronix.com</a> )
KickStart Startup Software	(available at <a href="http://www.tektronix.com">www.tektronix.com</a> )
LabVIEW and IVI Drivers	(available at <a href="http://www.tektronix.com">www.tektronix.com</a> )

## Available Accessories

### Test Leads and Probes

1754	2-wire Universal 10-Piece Test Lead Kit
5804	Kelvin (4-Wire) Universal 10-Piece Test Lead Kit
5805	Kelvin (4-Wire) Spring-Loaded Probes
5806	Kelvin Clip Lead Set
5808	Low Cost Single-pin Kelvin Probe Set
5809	Low Cost Kelvin Clip Lead Set
8605	High Performance Modular Test Leads
8606	High Performance Modular Probe Kit
8608	High Performance Clip Lead Set

---

## Cables, Connectors, Adapters

237-ALG-2	3-slot Male Triax Connector to 3 Alligator Clips
237-BAN-3A	Triax to Banana Plug
2450-TRX-BAN	Triax to Banana Adapter. Converts the 4 Triax adapters on the rear panel to 5 banana jacks
7078-TRX-*	3-slot, Low Noise Triax Cable
7078-TRX-GND	3-slot Male Triax To BNC Adapter (guard removed)
8607	2-wire, 1000V Banana Cables, 1 m (3.3 ft)
CA-18-1	Shielded Dual Banana Cable, 1.2 m (4 ft)
CAP-31	Protective Shield/Cap for 3-lug Triax Connectors
CS-1546	Triax 3-lug Special Shorting Plug. Shorts center pin to outer shield
CS-1616-3	Safety Interlock Mating Connector

---

## Communication Interfaces and Cables

7007-1	Shielded GPIB Cable, 1 m (3.3 ft)
7007-2	Shielded GPIB Cable, 1 m (6.6 ft)
CA-180-3A	CAT5 Crossover Cable for TSP-Link/Ethernet
KPCI-488LPA	IEEE-488 Interface for PCI Bus
KUSB-488B	IEEE-488 USB-to-GPIB Interface Adapter
USB-B-1	USB Cable, Type A to Type B, 1 m (3.3 ft)

---

## Triggering and Control

2450-TLINK	DB-9 to Trigger Link Connector Adapter.
8501-1	Trigger Link Cable, DIN-to-DIN, 1 m (3.3 ft)
8501-2	Trigger Link Cable, DIN-to-DIN, 2 m (6.6 ft)

---

## Rack Mount Kits

2450-BenchKit	Ears and Handle for 2450-NFP-RACK and 2450-RACK models
4299-8	Single Fixed Rack Mount Kit
4299-9	Dual Fixed Rack Mount Kit
4299-10	Dual Fixed Rack Mount Kit. Mount one 2450 and one Series 26xxB
4299-11	Dual Fixed Rack Mount Kit. Mount one 2450 and one Series 2400, Series 2000, etc.

---

## Test Fixtures

8101-PIV	DC Test Fixture
----------	-----------------

---

## Software Options

Kickstart	Instrument Control Software
ACS Basic Edition	Semiconductor Parametric Test Software for Component and Discrete Devices

## Available Services

2450-3Y-EW	1 Year Factory Warranty extended to 3 years from date of shipment
2450-5Y-EW	1 Year Factory Warranty extended to 5 years from date of shipment
C/2450-3Y-17025	KeithleyCare® 3 Year ISO 17025 Calibration Plan
C/2450-3Y-DATA	KeithleyCare 3 Year Calibration w/Data Plan
C/2450-3Y-STD	KeithleyCare 3 Year Std. Calibration Plan
C/2450-5Y-17025	KeithleyCare 5 Year ISO 17025 Calibration Plan
C/2450-5Y-DATA	KeithleyCare 5 Year Calibration w/Data Plan
C/2450-5Y-STD	KeithleyCare 5 Year Std. Calibration Plan

## Ordering Information

2450-EC	Graphical Potentiostat, 200 V, 1 A, 20 W Instrument
---------	-----------------------------------------------------

## Warranty Information

<b>Warranty Summary</b>	This section summarizes the warranties of the 2450. For complete warranty information, refer to the 2450 Reference Manual. Any portion of the product that is not manufactured by Keithley is not covered by this warranty and Keithley will have no duty to enforce any other manufacturer's warranties.
<b>Hardware Warranty</b>	Keithley Instruments, Inc. warrants the Keithley manufactured portion of the hardware for a period of one year from defects in materials or workmanship; provided that such defect has not been caused by use of the Keithley hardware which is not in accordance with the hardware instructions. The warranty does not apply upon any modification of Keithley hardware made by the customer or operation of the hardware outside the environmental specifications.
<b>Software Warranty</b>	Keithley warrants for the Keithley produced portion of the software or firmware will conform in all material respects with the published specifications for a period of ninety (90) days; provided the software is used on the product for which it is intended in accordance with the software instructions. Keithley does not warrant that operation of the software will be uninterrupted or error-free, or that the software will be adequate for the customer's intended application. The warranty does not apply upon any modification of the software made by the customer.



**Contact Information:**

**Australia\*** 1 800 709 465  
**Austria** 00800 2255 4835  
**Balkans, Israel, South Africa and other ISE Countries** +41 52 675 3777  
**Belgium\*** 00800 2255 4835  
**Brazil** +55 (11) 3759 7627  
**Canada** 1 800 833 9200  
**Central East Europe / Baltics** +41 52 675 3777  
**Central Europe / Greece** +41 52 675 3777  
**Denmark** +45 80 88 1401  
**Finland** +41 52 675 3777  
**France\*** 00800 2255 4835  
**Germany\*** 00800 2255 4835  
**Hong Kong** 400 820 5835  
**India** 000 800 650 1835  
**Indonesia** 007 803 601 5249  
**Italy** 00800 2255 4835  
**Japan** 81 (3) 6714 3010  
**Luxembourg** +41 52 675 3777  
**Malaysia** 1 800 22 55835  
**Mexico, Central/South America and Caribbean** 52 (55) 56 04 50 90  
**Middle East, Asia, and North Africa** +41 52 675 3777  
**The Netherlands\*** 00800 2255 4835  
**New Zealand** 0800 800 238  
**Norway** 800 16098  
**People's Republic of China** 400 820 5835  
**Philippines** 1 800 1601 0077  
**Poland** +41 52 675 3777  
**Portugal** 80 08 12370  
**Republic of Korea** +82 2 6917 5000  
**Russia / CIS** +7 (495) 6647564  
**Singapore** 800 6011 473  
**South Africa** +41 52 675 3777  
**Spain\*** 00800 2255 4835  
**Sweden\*** 00800 2255 4835  
**Switzerland\*** 00800 2255 4835  
**Taiwan** 886 (2) 2656 6688  
**Thailand** 1 800 011 931  
**United Kingdom / Ireland\*** 00800 2255 4835  
**USA** 1 800 833 9200  
**Vietnam** 12060128

\* European toll-free number. If not accessible, call: +41 52 675 3777



Find more valuable resources at [TEK.COM](http://TEK.COM)

Copyright © Tektronix. All rights reserved. Tektronix products are covered by U.S. and foreign patents, issued and pending. Information in this publication supersedes that in all previously published material. Specification and price change privileges reserved. TEKTRONIX and TEK are registered trademarks of Tektronix, Inc. All other trade names referenced are the service marks, trademarks or registered trademarks of their respective companies.

