

MASTECH®

MY70/74/74B

DIGITAL MULTIMETER OPERATION MANUAL

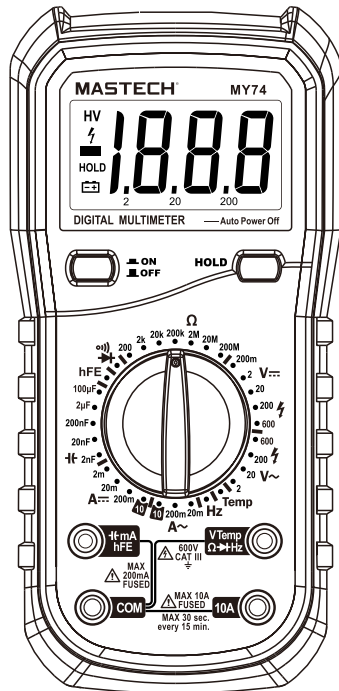

Intertek



CONTENTS

1. General instructions	1
1.1 Safety information	1
1.1.1 Safety instructions	1
1.1.2 Safe working habits	2
1.1.3 Safety symbols	4
1.1.4 Safe maintenance habits	5
1.2 Input protection measures	5
2. Meter appearance description	6
2.1. Meter appearance	6
2.2 LCD display	7
2.3 Input socket	8
3. Operating guidance	9
3.1 General operation	9
3.1.1 Reading maintenance mode	9
3.2 Measuring guidance	9
3.2.1 Measuring AC and DC voltage	9
3.2.2 Measuring resistance	10
3.2.3 Testing diode	11
3.2.4 Audible continuity testing	12
3.2.5 Measuring capacitance (MY74,MY74B)	12
3.2.6 Transistor measuring	13
3.2.7 Measuring frequency (MY74,MY74B)	13

CONTENTS

3.2.8 Measuring temperature (MY74,MY74B)	14
3.2.9 Measuring current	14
4. Technical indicators	16
4.1. Comprehensive indicators	16
4.2. Accuracy indicators	17
4.2.1 DC voltage	17
4.2.2 AC voltage	17
4.2.3 Frequency (only for MY74,MY74B)	18
4.2.4 Resistance	18
4.2.5 Diode	18
4.2.6 Audible continuity	19
4.2.7 Transistor	19
4.2.8 Capacitance (only for MY74,MY74B)	19
4.2.9 Temperature (only for MY74,MY74B)	19
4.2.10 DC current	20
4.2.11 AC current	20
5. Meter maintenance	21
5.1 General maintenance	21
5.2 Replace battery and fuse	21
5.3 Replacing Test Leads	21
5.4 Cleaning and Decontamination	21
6. Accessories	21

1. General instructions

The meter is designed and manufactured according to safety requirements of EN/UL/CSA 61010-1, 61010-2-030, 61010-2-033 on electronic measuring instrument and hand held digital multipurpose meter. The product meets with the requirements of 600V CAT III and pollution degree 2.

- All safety guidelines outlined should be followed, If the equipment is used in a manner not specified by the manufacturer, the protection provided by the equipment may be impaired.
- Warning symbols in the manual alert users of potential dangerous situations.
- Precautions are to prevent the user from damaging the instrument or the test object.

WARNING:

The special attention should be paid when using the meter because the improper usage may cause electric shock and damage the meter. The safety measures in common safety regulations and operating instruction should be complied with when using. In order to make fully use of its functions and ensure safe operations please comply with the usage in this section carefully.

1.1 Safety information

1.1.1 Safety instructions

- * When using this meter, the user should comply with the following standard safety procedures:
 - The safety procedures to prevent electric shock
 - The safety procedures to prevent wrong use
- * To ensure your safety, please use the test probe provided with the meter. Before use, please check and make sure that it is intact.









1.1.2 Safe working habits

- * If the meter is used near a source of significant electromagnetic interference, meter readings will become unstable and have large errors.
- * Don't use the meter or probe when it is broken.
- * If you do not use the meter in accordance with the instructions, safety functions provided by the meter may become invalid.
- * When you work around the bare conductor or bus bar, you should be extremely careful.
- * Do not use the meter near explosive gas, vapor or dust.
- * Measure known voltage with meter to verify that the meter is working properly. If the meter is working abnormally, do not use. Protective equipment may be damaged. If there is doubt, the meter should be sent to repair.
- * The meter should be used with correct input, function and measuring range.
- * When you can't determine the size range of signal to be tested, please switch the measuring range to the maximum position.
- * Input value can't exceed the input limit specified in each measuring range to prevent damage to the meter.
- * When the meter is connected to the circuit being measured, do not touch the unused input end.
- * When the voltage to be tested exceeds 60Vdc or 30Vac effective value, please operate carefully to prevent electric shock.
- * When you measure with test probe, first connect the common testing end of black test probe to the common testing end of circuit to be tested, then connect red test leads to the test circuit of the test probe to the test end of circuit to be tested. When the measurement is completed, you should first remove the red test probe, then remove the black common test probe.

- * When use the test probe to measure, you should place your fingers at the back of retaining ring.
- * Before changing the measuring range, you must ensure that the test probe is not connected to circuit to be tested.
- * For all DC functions, including manual or automatic measuring range, to avoid the risk of electric shock due to possible incorrect readings, please use AC function to verify the existence of any AC voltage. Then, select DC voltage measuring range equal to or greater than the AC measuring range.
- * Before testing resistance, diode, capacitance measurement or on-off states, you should first cut off power to the circuit being tested, and discharge all high voltage capacitors.
- * Don't measure resistance or make on-off tests on a live circuit.
- * Before current measurement, you should firstly check the meter's fuse. Before the meter is connected to the circuit under testing, you should firstly power off the circuit to be tested.
- * When you make TV repairs or measure power conversion circuits, you should note the high amplitude voltage pulse of circuits being tested. The TV filter should be used to weaken these pulses to avoid the meter damage.
- * This meter uses a 9V 6F22 battery. The battery should be properly installed in the meter's battery compartment.
- * When the battery indicator  appears, the battery should be replaced immediately. Low battery will cause meter reading errors, and possibly result in electric shock or personal injury
- * When you make type III voltage measurement, the voltage should not exceed 600V; when you make type TV voltage measurement, the voltage should not exceed 600V.
- * When the meter shell (or part of shell) is removed, do not use the meter.

1.1.3 Safety symbols

Symbols used on the meter surface and instructions:

	Note-Important safety information, refer to the instruction manual.
	Caution, possibility of electric shock
	Equipment protected throughout by double insulation or reinforced insulation.
	Conforms to UL STD. 61010-1, 61010-2-030, 61010-2-033; Certified to CSA STD. C22.2 NO. 61010-1, 61010-2-030, 61010-2-033
	Complies with European (EU) safety standards
	Earth (ground) TERMINAL
	Direct current
	Alternating current
CAT III	MEASUREMENT CATEGORY III is applicable to test and measuring circuits connected to the distribution part of the building's low-voltage MAINS installation.

1.1.4 Safe maintenance habits

- * To open the meter shell or remove the battery cover, you should first pull out the test probe.
- * When performing meter maintenance, you should use specified replacement parts.* Before opening the meter, you should disconnect all power supplies and ensure that you have no static electricity to avoid damaging the meter components.
- * Meter calibration, maintenance, repair and other operations only can be performed by technicians who fully understand the meter and electrical shock hazards.
- * Before opening the meter, you should be aware that there may be dangerous voltages remaining in some capacitances in the meter even after powering off.
- * If you find any abnormal phenomena on the meter, the meter should be immediately turned off and repaired. Ensure that it can not be used before passing inspection.
- * When the meter is not used for a long time, please remove the battery and avoid storing it in a high temperature and humidity environment.

1.2 Input protection measures

- * When making voltage measurements (not including 200mV grade), the maximum input voltage is 600V DC or 600V AC. (The maximum input voltage of 200mV grade is 250V AC or equivalent RMS value voltage).
- * When making frequency, resistance, temperature, mA current, and diode hFE measurements, the meter is protected through a fuse (FF 400mA H 600V).

2. Meter appearance description

2.1. Meter appearance

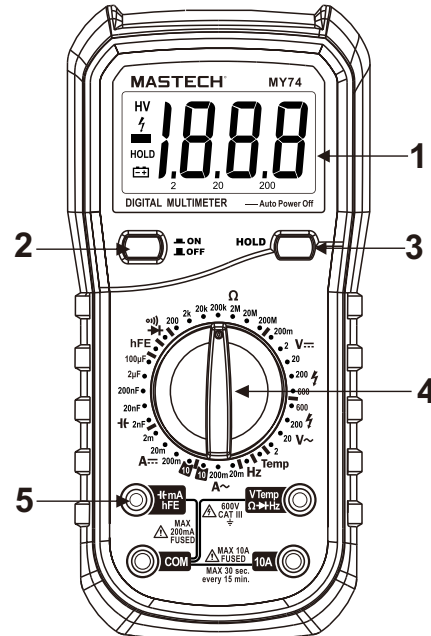

- 1. LCD (liquid crystal display)
- 2. Mains Switch
- 3. HOLD Key
- 4. Rotary Switch
- 5. Input Socket

2.2 LCD display

See Table 1 for information about the display.

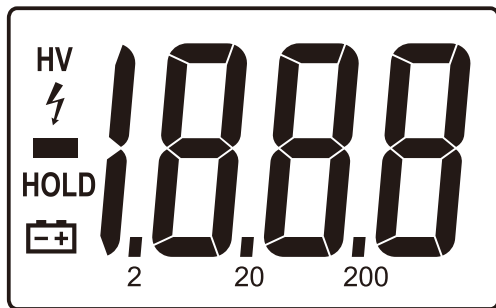

Fig. 1 Display

Table 1 Display Symbols

Symbols	Indication
	Low battery. ⚠ To avoid wrong readings causing electric shock or personal injury, when the low battery symbol appears, the battery should be replaced immediately.
	Negative input polarity indication
HV	High voltage symbol, in AC600V or DC600V.
HOLD	Keep the current measurement value

2.3 Input socket

Table 2 Input Socket

Input Socket	Description
COM	All common input ends to be measured are connected with common output socket of black test probe or dedicated multifunction test socket.
VΩHz TEMP	Positive input end of voltage, resistance, frequency, diode, buzzer measurement and temperature test (connected with the red test probe).
mA, hFE	Positive input end of current mA, temperature and triode hFE (connected with output socket of black test probe or dedicated multifunction test socket).
10A	Positive input end of 10A (connected with the red test probe).

3. Operating guidance

3.1 General operation

3.1.1 Reading maintenance mode

In reading maintenance mode, the current readings will be kept on the display. Change the measurement function grade, or press **HOLD** key to exit reading maintenance mode.

To enter and exit reading maintenance mode:

1. Press "**HOLD**" key, the reading will be maintained and "**H**" symbol will display on LCD display simultaneously.
2. Press "**HOLD**" key again to return the meter to normal measurement state.

3.1.2 Battery saving energy function

The meter power will disconnect automatically after about 40 minutes, to save battery power.

3.2 Measuring guidance

3.2.1 Measuring AC and DC voltage

WARNING:

To prevent electrical shock and/or meter damage. Don't measure any RMS voltage higher than 600V DC or 600VAC between common end and ground.

Voltage is the potential difference between two points. AC voltage polarity changes over time, while DC voltage polarity does not change over time. DC voltage measuring range of this meter: 200.0mV, 2.000V, 20.00V, 200.0V and 600V; AC voltage measuring range of this meter: 200mV (only for MY70), 2.000V, 20.00V, 200.0V and 600V.

To measure AC and DC voltage:

1. Rotate the switch to the appropriate position.
2. Respectively connect black and red test probe to COM input socket and V input socket.
3. Measure the voltage of circuit to be tested with other two ends of test probes. (Connected with the circuit to be tested in parallel)
4. Read the measuring voltage value from LCD display. When measuring DC voltage, the display will simultaneously show the voltage polarity which is connected with red test probe.

• **Note:**

In the DC 200mV and AC 2V measuring range, the meter will have a number of displays even without input or connecting with test probe. In this case, just make a short circuit between "V-" and "COM", so that the meter will display zero.

3.2.2 Measuring resistance

WARNING:

To avoid damaging meter or device to be measured, before measuring resistance, cut off all circuits being tested and discharge all high voltage capacitors.

Resistance is resistance force of current. The unit of resistance is ohm (Ω).

Resistance range of this meter: 200.0 Ω , 2.000k Ω , 20.00k Ω , 200.0k Ω , 2.000M Ω , 20.00M Ω , 200.0 M Ω .

To measure resistance:

1. Rotate switch to the appropriate position.
2. Respectively connect black and red test probe to V Ω input socket and V input socket.
3. Measure the resistance value of circuit to be tested with other two ends of test probes.
4. Read the measuring resistance value from LCD display.

Here are some tips for measuring resistance:



- The resistance measured on circuit is usually different from the rated value of resistance. This is because the test current of the meter will flow through all possible channels between test probes.
- When measuring low resistance, in order to accurately measure, make a short circuit between two test probes to read the resistance value when short circuited. This resistance value should be subtracted after measuring the resistance to be tested.
- At grade 20MΩ and 200 MΩ, the reading will be stable after several seconds. A high resistance measuring is normal.
- When there is no input (for example, in an open circuit), the display will show “1”, which means that the measured value is out of range.

3.2.3 Testing diode

WARNING:

To avoid damaging meter or device to be measured, before measuring diodes, cut off all circuits being tested and discharge all high voltage capacitors.

To test diode outside circuit:

1. Rotate the switch to  position.
2. Respectively connect black and red test probe to COM input socket and  input socket.
3. Respectively connect black and red test probe to negative pole and positive pole of the diode to be tested.
4. The meter will display the forward bias voltage value of diode being tested. If the test probe polarity is reversed, the meter will display “1”.



In a circuit, a good diode should still produce a forward voltage drop of 0.5V to 0.8V; but the reverse bias voltage will vary depending on resistance values of other channels between two test probes.

3.2.4 Audible continuity testing

WARNING:

To avoid damaging meter or device to be measured, before testing buzzer continuity, cut off all circuits being tested and discharge all high voltage capacitors.

To make continuity testing:

1. Rotate the switch to  position.
2. Respectively connect black and red test probe to COM input socket and  input socket.
3. Measure the resistance value of circuit to be tested with other two ends of test probes
4. During on-off testing, if the measured circuit resistance is not greater than about 50, the buzzer will sound continuously.

3.2.5 Measuring capacitance (MY74, MY74B)

WARNING:

To avoid damaging meter or device to be measured, before measuring capacitance, cut off all circuits being tested and discharge all high voltage capacitors. Determine that capacitors are discharged with DC voltage measurement function.

Capacitance range of this meter: 2.000nF, 20.00nF, 200.0nF, 2.000μF and 100.0μF.

To measure capacitance:

1. Rotate switch to the appropriate position.
2. Respectively connect black and red test probe to COM input socket and  input socket.
3. Measure the capacitance value of circuit to be tested with other two ends of test probes and read the measuring value from LCD display.

Here are some tips for measuring capacitance:

- When measuring bulk capacitor with this meter, readings will stabilize after a few seconds.

- To improve the accuracy below 2nF, subtract the distributed capacitance of meter and cable.

3.2.6 Transistor measuring

⚠ WARNING:

To prevent electrical shock and/or meter damage. Don't apply any RMS voltage higher than 250V DC or AC between common end and mA end,

1. Rotate the switch to hFE position.
2. Plug multi-function socket with correct polarity (the "+" end of multi-function socket is connected with mA end, "COM" end is connected with common end).
3. Determine that the transistor is NPN or PNP type, then insert three pins of transistor to the corresponding holes of the dedicated multi-functional socket
4. Read hFE approximation of transistor to be measured from LCD display.

3.2.7 Measuring frequency (MY74, MY74B)

⚠ WARNING:

To prevent electrical shock and/or meter damage. Don't measure the frequency of RMS voltage higher than 250V DC or AC.

To measure frequency:

1. Rotate the switch to Hz position.
2. Respectively connect black and red test probe to COM input socket and Hz input socket.
3. Measure the frequency value of circuit to be tested with other two ends of test probes.
4. Read the measuring frequency value from LCD display.

3.2.8 Measuring temperature (MY74, MY74B)

⚠ WARNING:

Don't measure the surface of object with electric quantity higher than 60V DC or 24V AC RMS, to prevent electrical shock. Don't measure the temperature in a microwave oven to prevent fire or meter damage.

To measure temperature:

1. Plug the red end of the K-type thermocouple into the "VtempΩ→Hz" jack and black end into the "COM" jack.
2. Set the rotary switch to the "Temp" position.
3. Touch the surface of the object or area with the temperature sensor for measurement.
4. Read the measuring value from LCD display.

3.2.9 Measuring current

⚠ WARNING:

When the ground voltage of open circuit voltage exceeds 250V, do not try to make current measurements on the circuit. If the fuse is blown when making a measurement, you may damage the meter or injure yourself. To avoid damage to meter or device, before measuring current, please check the meter's fuse. When measuring, you must use the correct input socket, function and measuring range. When the test probe is inserted to the current input socket, don't connect the other end of the test probe with any circuit in parallel



Current range of this meter: 20μA/200μA (only for MY70)
2.000mA, 20.00mA, 200.0mA and 10.00A;

To measure current:

1. Cut off the power supply of circuit to be tested. Discharge all high voltage capacitors on the circuit to be tested.
2. Rotate switch to the appropriate position.
3. Connect the black test probe to the COM input socket. If the current to be tested is lower than 200mA, connect the red test probe to the mA input socket. If the measured current is between the range of 200mA~10A, the red test probe should be connected to 10A input socket.
4. Cut off the circuit to be tested. The black test probe is connected to one end of disconnected circuit (low voltage relatively), and the red test probe is connected to the other end of disconnected circuit (high voltage relatively). (Connecting test probe in reverse would make the reading negative, but the meter won't be damaged.)
5. Connect the power supply of circuit, then read the display reading. If the display shows only "1", the input is out of the selected input range, therefore please rotate the switch to a higher measuring range.
6. Cut off the power supply of circuit to be tested. Discharge all high voltage capacitors. Remove the test probe of meter and restore the circuit to its original condition.

4. Technical indicators

4.1. Comprehensive indicators

- Operating environment and condition:
600V CAT III pollution grade: 2
Elevation < 2000 m
Environment temperature and humidity:
0~40 °C (<80% RH, <10°C, it is not to be considered).
Storage temperature and humidity:
0~60 °C (<70% RH, remove the battery).
- Temperature coefficient: 0.1 Accuracy /°C(<18°C or >28°C).
- The maximum allowable voltage between measurement end and ground: 600V DC or 600V AC RMS
- Fuse protection:
mA grade: Fuse F1 FF 400mA H 600V;
A grade: Fuse F2 FF 10A H 600V.
- Sampling rate: about 3 times/sec.
- Maximum value display: 1999. Automatically display unit symbols in accordance with measurement function grade.
- Over-range indication: LCD will show "1".
- Low battery indication: When the battery voltage is lower than the normal operating voltage, "  " will display on the LCD display.
- Input polarity indication: automatically display " - " symbol.
- Power supply: DC 9V 
- Battery type: NEDA 1604, 6F22 or 006P.
- Outside measurement: 188 mm(L)×93 mm(W)×50mm(H).
- Weight: about 380g (include battery).

4.2. Accuracy indicators

Accuracy: \pm (% reading + word) with one year of warranty.
Reference conditions: environmental temperature is from 18 °C to 28 °C, relative humidity is not more than 80%.

4.2.1 DC voltage

Measuring range	Resolution	Accuracy
200mV	0.1mV	$\pm(0.5\%$ of reading + 2digits)
2V	1mV	
20V	10mV	
200V	100mV	
600V	1V	$\pm(0.8\%$ of reading + 2digits)

Input impedance: 10M Ω

Maximum input voltage: 600Vdc or 600Vac RMS, 250Vdc or ac RMS with the measuring range of 200mV.

4.2.2 AC voltage

Measuring range	Resolution	Accuracy
200mV (only for MY70)	0.1mV	$\pm(1.2\%$ of reading + 3digits)
2V	1mV	$\pm(0.8\%$ of reading + 3digits)
20V	10mV	
200V	100mV	
600V	1V	$\pm(1.2\%$ of reading + 3digits)

Input impedance: 10M Ω

Maximum input voltage: 600Vdc or 600V ac RMS, 250Vdc or ac RMS with the measuring range of 200mV.

Frequency response: 40Hz-400Hz sine wave RMS
(average response)

The frequency response is 200Hz for 600V

4.2.3 Frequency (only for MY74, MY74B)

Measuring range	Resolution	Accuracy
20kHz	10Hz	$\pm(2.0\%$ of reading + 5digits)

Input voltage range: 200mV-10V ac RMS

Overload protection: 250V dc or 250V ac RMS

4.2.4 Resistance

Measuring range	Resolution	Accuracy
200 Ω	0.1 Ω	$\pm(0.8\%$ of reading + 3digits)
2k Ω	1 Ω	$\pm(0.8\%$ of reading + 2digits)
20k Ω	10 Ω	
200k Ω	100 Ω	
2M Ω	1k Ω	
20M Ω	10k Ω	$\pm(1.0\%$ of reading + 2digits)
200M Ω	100k Ω	$\pm(6.0\%$ of reading + 10digits)

Overload protection: 250V dc or 250V ac RMS

Open circuit voltage: below 700mV

4.2.5 Diode

Function	Measuring range	Resolution	Test environment
Diode Test 	1V	0.001V	Test current: about 1mA Open circuit voltage: about 2.8V. Display approximation of diode forward voltage drop.

Overload protection: 250V dc or 250V ac RMS

4.2.6 Audible continuity

Function	Description	Test environment
o)))	When built-in buzzer sounds, the resistance to be tested is not more than 50Ω.	Test current: about 1mA. Open circuit voltage: about 2.8V.

4.2.7 Transistor

Measuring range	Description	Test environment
hFE	hFE approximation on the display, (0 -1000)	Base current 10μA Vce is about 2.8V

Overload protection: Fuse (FF 400mA H 600V)

4.2.8 Capacitance (only for MY74, MY74B)

Measuring range	Resolution	Accuracy
2nF	1pF	±(4.0% of reading + 3digits)
20nF	10pF	
200nF	0.1nF	
2μF	1nF	
100μF	100nF	±(6.0% of reading + 10digits)

Overload protection: Fuse (FF 400mA H 600V)

4.2.9 Temperature (only for MY74, MY74B)

Measuring range	Resolution	Accuracy
-20°C~0°C	1°C	±(5.0% of reading + 4digits)
1°C~400°C		±(2.0% of reading + 3digits)
401°C~1000°C		±(2.0% of reading + 5digits)

Temperature indicator does not include thermocouple error.

Overload protection: Fuse (FF 400mA H 600V)

4.2.10 DC current

Measuring range	Resolution	Accuracy
20μA (for MY70, MY74B)	0.01μA	±(2.0% of reading + 5digits)
200μA (only for MY70)	0.1μA	±(0.8% of reading + 1digits)
2mA (for MY70, MY74)	1μA	
20mA	10μA	±(1.5% of reading + 1digits)
200mA	0.1mA	
10A	10mA	

Overload protection: fuse with measuring range of mA (FF400mA H 600V); fuse with measuring range of 10A (FF10A H 600V).

Maximum input current: mA grade: 200mA DC or AC RMS;

10A grade: 10A DC or AC RMS

When measured current is greater than 10A, continuous measurement time should not be more than 10 seconds. Stop the current being measured after 15 minutes.

4.2.11 AC current

Measuring range	Resolution	Accuracy
20μA (for MY70)	0.01μA	±(2.0% of reading + 5digits)
200μA (only for MY70)	0.1μA	±(1.0% of reading + 5digits)
2mA (for MY70, MY74)	1μA	
20mA	10μA	±(1.8% of reading + 5digits)
200mA	0.1mA	
10A	10mA	

Overload protection: fuse with measuring range of mA (FF400mA H 600V); fuse with measuring range of 10A (FF10A H 600V)

Maximum input current: mA grade: 200mA DC or AC RMS; 10A grade: 10A DC or AC RMS

When measured current is greater than 10A, continuous measurement time should not be more than 10 seconds. Stop the current being measured after 15 minutes.

Frequency response: 40Hz-400Hz, sine wave RMS
(average response)

5. Meter maintenance

This section provides basic maintenance information, including instructions for replacement of fuse and battery. Do not try to repair the meter unless you are an experienced maintenance person with the relevant calibration, performance testing and maintenance data

5.1 General maintenance

⚠ WARNING:

To avoid electrical shock or damage to the meter, don't wet the inner surfaces of the meter. Before opening shell or battery cover, you should remove the connecting cable between the test probe and the input signal.

Regularly clean the meter shell with damp cloth and a small amount of detergent. Do not use abrasives or chemical solvents. If you make input socket dirty or wet, it may affect the readings.

To clean input socket:

Turn off the meter, and pull out all test probes from the input socket.

Remove all dirt from the socket.

Apply detergent or lubricant (such as WD-40) to a new cotton ball.

Clean each socket with a cotton ball. Lubricant can prevent contamination related with moisture on the socket.

5.2 Replace battery and fuse

⚠ WARNING:

To avoid electrical shock or personal injury, before opening the battery cover to replace battery, you should turn the meter off and make sure that the test probe is disconnected from the measurement circuit.

To avoid wrong readings, electric shock or personal injury, when “” appears on the meter display, replace the battery immediately.

Use only a fuse with specified amperage, fusing rated value, voltage rated value and fusing speed (F1:FF 400mA H 600V, F2:FF 10A H 600V)

Please follow below steps to replace battery or fuse:

1. Turn off the power supply of the meter.
2. Pull out all test probes from the input socket.
3. Loosen two screws on the fixed battery cover with screwdriver.
4. Remove the battery cover.
5. Remove the old battery or damaged fuse.
6. Replace with a new battery with 9V (6F22) or a new fuse.
7. Replace the battery cover and tighten the screws.

5.3 Replacing Test Leads

If insulation on leads is damaged, replace it.

⚠ WARNING:

Use meet EN 61010-031 standard, rated CAT III 600V, 10A or better test leads.

5.4 Cleaning and Decontamination

1. The meter can be cleaned with a soft cloth to remove any oil, grease or grime.
2. Do not use liquid solvent or detergent.

6. Accessories

- | | |
|-----------------|------|
| • Test Leads | 1set |
| • Package | 1pcs |
| • 9V Battery | 1pcs |
| • User's Manual | 1pcs |

