



Dual-Channel Arbitrary Waveform Generator

User Manual

- AG1012F
- AG1022F
- AG2052F
- AG2062F

WWW.OWON.COM.HK

Oct. 2014 edition V2.1

Copy Right in this Manual © Lilliput Company. All rights Reserved.

The Lilliput's products are under the protection of the patent rights in America and other countries, including ones which have already obtained the patent rights and those which are applying for. The information in this manual will replace all that in the materials published originally.

The information in this manual was correct at the time of printing. However, OWON will continue to improve products and reserves the rights to changes specification at any time without notice.

OWON is the registered trademark of the Lilliput Company.

Headquarter: Fujian Lilliput Optoelectronics Technology Co.,Ltd.: The mansion of optoelectronics, 19 Heming Road, Lantian industrial zone, Zhangzhou, Fujian, China

Tel:+86-596-2130430

Fax:+86-596-2109272

Web: www.owon.com.hk

Mail: Business Consulting: info@owon.com.hk

Sale service: service@owon.com.hk

Branch: Xiamen Lilliput Technology Co.,Ltd.: the 5th floor, B Area, Chuangxin Mansion, Software Park, ZhenZhuWan, Huandao RD, Xiamen, Fujian, China

Tel:+86-592-2575666

Fax:+86-592-2575669

General Warranty

Lilliput warrants that the product will be free from defects in materials and workmanship for a period of 3 years (1 year for accessories) from the date of purchase of the product by the original purchaser from the Lilliput Company. This warranty only applies to the original purchaser and is not transferable to the third party. If the product proves defective during the warranty period, Lilliput either will repair the defective product without charge for parts and labor, or will provide a replacement in exchange for the defective product. Parts, modules and replacement products used by Lilliput for warranty work may be new or reconditioned to like new performance. All replaced parts, modules and products become the property of Lilliput.

In order to obtain service under this warranty, Customer must notify Lilliput of the defect before the expiration of the warranty period. Customer shall be responsible for packaging and shipping the defective product to the service center designated by Lilliput, and with a copy of customer proof of purchase.

This warranty shall not apply to any defect, failure or damage caused by improper use or improper or inadequate maintenance and care. Lilliput shall not be obligated to furnish service under this warranty a) to repair damage resulting from attempts by personnel other than Lilliput representatives to install, repair or service the product; b) to repair damage resulting from improper use or connection to incompatible equipment; c) to repair any damage or malfunction caused by the use of non-Lilliput supplies; or d) to service a product that has been modified or integrated with other products when the effect of such modification or integration increases the time or difficulty of servicing the product.

Please contact the nearest Lilliput's Sales and Service Offices for services or a complete copy of the warranty statement.

For better after-sales service, please visit www.owon.com.hk and register the purchased product online.

Excepting the after-sales services provided in this summary or the applicable warranty statements, Lilliput will not offer any guarantee for maintenance definitely declared or hinted, including but not limited to the implied guarantee for marketability and special-purpose acceptability. Lilliput should not take any responsibilities for any indirect, special or consequent damages.

Table of Contents

1.General Safety Requirements.....	1
2.Safety Terms and Symbols	2
3.General Characteristics	3
4.Quick Start.....	4
Front/Rear Panel and User Interface	5
Front Panel	5
Rear Panel	6
User Interface.....	7
General Inspection	8
Foot Stool Adjustment	8
Power-On Check	9
AC Power Input Setting	9
Power On.....	9
5.Front Panel Operation	10
To set channels	11
To set signals	12
To Output Sine Signals.....	12
To Set the Frequency/Period	12
To Set the Amplitude	13
To Set the Offset	13
To Set the High Level.....	13
To Set the Low Level	13
To Output Square Signals	13
To Set the Duty Cycle	14
To Output Ramp Signals	15
To Set the Symmetry.....	15
To Output Pulse Signals.....	16
To Set the Pulse Width / Duty Cycle	17
To Output Noise Signals	17
To Output Arbitrary Signals.....	18
To Select the Built-in Waveform.....	19
The User-Definable Waveform.....	20
To Output DC.....	22
To recall wave file.....	22
Use SDS Series oscilloscope manufactured by OWON to cut wave:	22
Use waveform generators to recall wave:	23
To Generate the Modulated Waveform	24

AM (Amplitude Modulation)	25
FM (Frequency Modulation)	26
PM (Phase Modulation).....	27
FSK (Frequency Shift Keying)	28
PWM (Pulse Width Modulation) (only in AG2052F and AG2062F)	29
To Generate Sweep	29
To Generate Burst.....	31
Set the N-Cycle Burst.....	31
Set the Gated Burst	32
To Save and Recall	33
To Use USB Storage	33
To Edit the File Name	33
To Set the Utility Function	34
To Set Display Parameter	34
To Set the Bright	34
To Set the Separator	34
To Set the Screen Saver.....	34
To Set the Counter	35
To Set Output Parameter	35
To Set the Output Load	35
To Set the Phase Deviation	36
To Set the System	36
Language Setting.....	36
Power On Setting	36
To Return to Default Setting.....	36
To Set the Beep	38
View System Information	38
To Set the Clock Source.....	38
To Use Built-in Help	38
<i>6.Communication with PC</i>	<i>39</i>
<i>7.SCPI.....</i>	<i>40</i>
<i>8.Troubleshooting</i>	<i>40</i>
<i>9.Technical Specifications</i>	<i>41</i>
<i>10.Appendix.....</i>	<i>47</i>
Appendix A: Enclosure	47
Appendix B: General Care and Cleaning	47

1. General Safety Requirements

Before any operations, please read the following safety precautions to avoid any possible bodily injury and prevent this product or any other products connected from damage. In order to avoid any contingent danger, this product is only used within the range specified.

Check AC power input setting according to the standards in your own country (see page 9, *AC Power Input Setting*).

Only the qualified technicians can implement the maintenance.

To avoid Fire or Personal Injury:

- **Use Proper Power Cord.** Use only the power cord supplied with the product and certified to use in your country.
- **Product Grounded.** This instrument is grounded through the power cord grounding conductor. To avoid electric shock, the grounding conductor must be grounded. The product must be grounded properly before any connection with its input or output terminal.
- **Check all Terminal Ratings.** To avoid fire or shock hazard, check all ratings and markers of this product. Refer to the user's manual for more information about ratings before connecting to the instrument.
- **Do not operate without covers.** Do not operate the instrument with covers or panels removed.
- **Use Proper Fuse.** Use only the specified type and rating fuse for this instrument.
- **Avoid exposed circuit.** Do not touch exposed junctions and components when the instrument is powered.
- **Do not operate if in any doubt.** If you suspect damage occurs to the instrument, have it inspected by qualified service personnel before further operations.
- **Use your instrument in a well-ventilated area.** Make sure the instrument installed with proper ventilation, refer to the user manual for more details.
- **Do not operate in wet conditions.**
- **Do not operate in an explosive atmosphere.**
- **Keep product surfaces clean and dry.**

2. Safety Terms and Symbols

Safety Terms

Terms in this Manual. The following terms may appear in this manual:



Warning: Warning indicates the conditions or practices that could result in injury or loss of life.



Caution: Caution indicates the conditions or practices that could result in damage to this product or other property.

Terms on the Product. The following terms may appear on this product:

Danger: It indicates an injury or hazard may immediately happen.

Warning: It indicates an injury or hazard may be accessible potentially.

Caution: It indicates a potential damage to the instrument or other property might occur.

Safety Symbols

Symbols on the Product. The following symbol may appear on the product:



Hazardous Voltage



Refer to Manual



Protective Earth Terminal



Chassis Ground



Test Ground

3. General Characteristics

These products are dual-channel multi-function generator which combines Arbitrary Waveform Generation and Function Generation. The product introduces Direct Digital Synthesizer (DDS) technology to provide stable, precise, pure and low distortion signal. The user-friendly interface design and panel layout bring exceptional user experience. Support USB storage device. Provide more alternative solutions for users.

Features and benefits:

- ◆ 3.9 inch high resolution (480 × 320 pixels) TFT LCD display;
- ◆ Advanced DDS technology, max. 60 MHz frequency output;
- ◆ Max. Sample rate: 250 MSa/s, Frequency resolution: 1 μ Hz;
- ◆ Vertical resolution: 14 bits, max. 1 M waveform record length;
- ◆ Abundant waveform output: 5 basic waveforms and 45 built-in arbitrary waveforms output;
- ◆ Exponential rise, Exponential fall, $\text{Sin}(x)/x$, Staircase, etc. 45 built-in waveforms and user defined arbitrary waveform;
- ◆ Abundant modulation functions along with output liner/logarithm sweep and pulse string waveform;
- ◆ Standard interface: USB port, USB (type B) connector.

4. Quick Start

This chapter will deal with the following topics mainly:

- **Front/Rear Panel Overview**
- **User Interface Overview**
- **How to Implement General Inspection**
- **How to Adjust the Foot Stools**
- **How to Implement Power-On Check**

Front/Rear Panel and User Interface

Front Panel

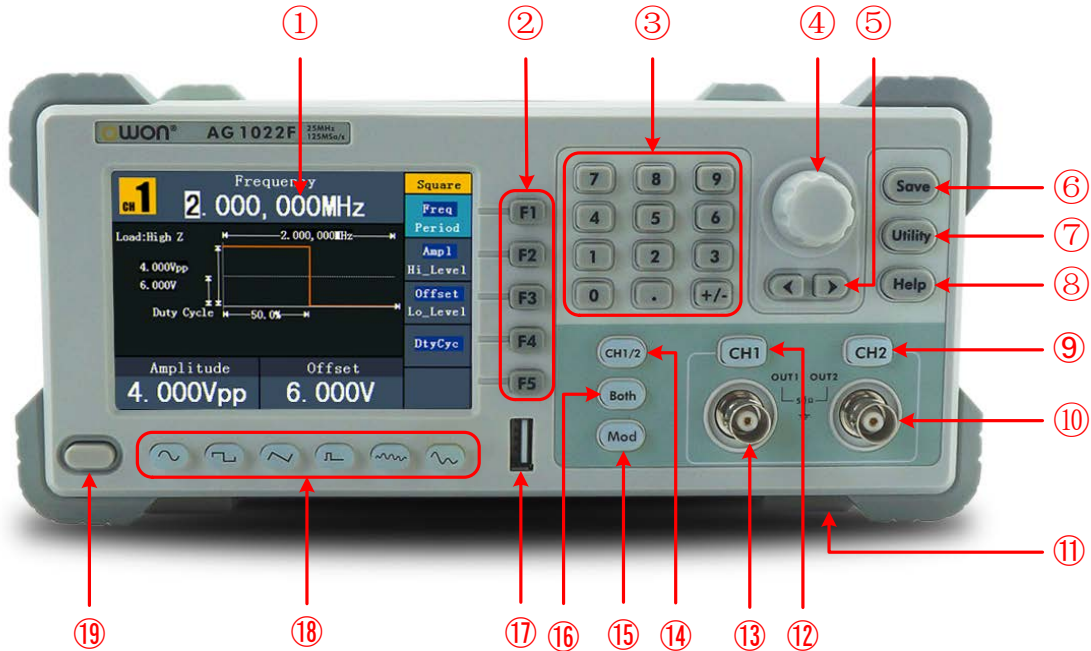







Figure 4-1 Front panel overview (AG1022F shown)

① LCD	Display the user interface
② Menu selection buttons	Include 5 buttons: F1 - F5, activate the corresponding menu
③ Number keys	Input parameters, include: number, point and plus/minus sign
④ Knob	Change the current highlighted number, also can be used to select file location or switch the character of the soft keyboard when entering file name. In Sweep and N-Cycle Burst, if you choose Source as "Manual", every time you press this knob, the generator will be triggered once. In signal output interface, press this knob to enter Channel Copy menu.
⑤ Direction key	Move the cursor of the focused parameter or select the file locations
⑥ Save button	Store/recall the user-defined arbitrary waveform data or instrument state
⑦ Utility button	Set the auxiliary system function.
⑧ Help button	View the build-in help information

4.Quick Start

⑨	CH2 Output Control	Turn on/off the output of CH2. The backlight will be lighted when CH2 is tuned on.
⑩	CH2 Output	Output signal of CH2
⑪	Foot stool	Make the instrument to be tilted for ease of operation
⑫	CH1 Output Control	Turn on/off the output of CH1. The backlight will be lighted when CH1 is tuned on.
⑬	CH1 Output	Output signal of CH1
⑭	CH1/2 button	Switch channel displayed on the screen between CH1 and CH2.
⑮	Modulation (Mod)	Generate the Modulated waveforms, Sweep and Burst; these functions are only used for CH1.
⑯	Both button	Display the editable parameters of both channels. When the function is enabled, the backlight of the button turns on.
⑰	USB port	Connect with an external USB device, such as connect a USB device to the instrument.
⑱	Waveform selection buttons	Include: Sine  , Square  , Ramp  , Pulse  , Noise  and Arbitrary  waveform. When a waveform is selected, the backlight of the button turns on.
⑲	Power button	Turn on/off the generator

Rear Panel

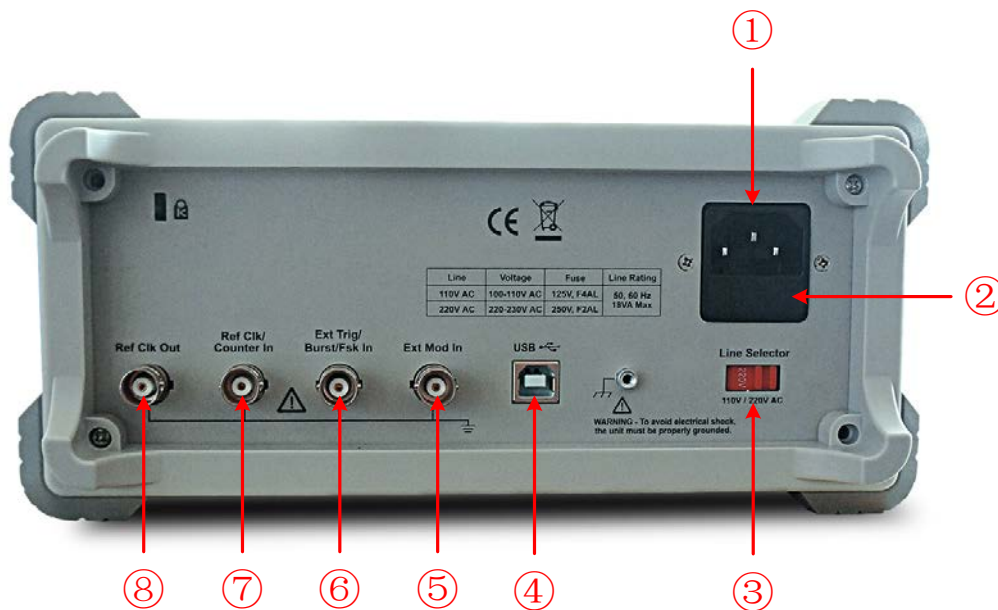

Figure 4-2 Rear panel overview

① Power socket	AC input connector
② Fuse	Use the specified fuse according to the voltage scale.
③ Power switch	Switch between 110 V and 220 V.
④ USB (type B) connector	This can be used to connect a USB type B controller. Connect with an external device, such as connected to a PC and controlled via PC software.
⑤ Ext Mod In Connector	External modulation input, use it as external signal source.
⑥ Ext Trig/Burst/Fsk In connector	This signal can be used as external signal source in Sweep, Burst and FSK mode.
⑦ Ref Clk/Counter In connector	To accept an external clock signal, or to accept the input signal of counter. (See page 38, <i>To Set the Counter</i>)
⑧ Ref Clk Out connector	To synchronize generators. Output a clock signal generated by the crystal inside the generator. (See page 38, <i>To Set the Clock Source</i>)

User Interface

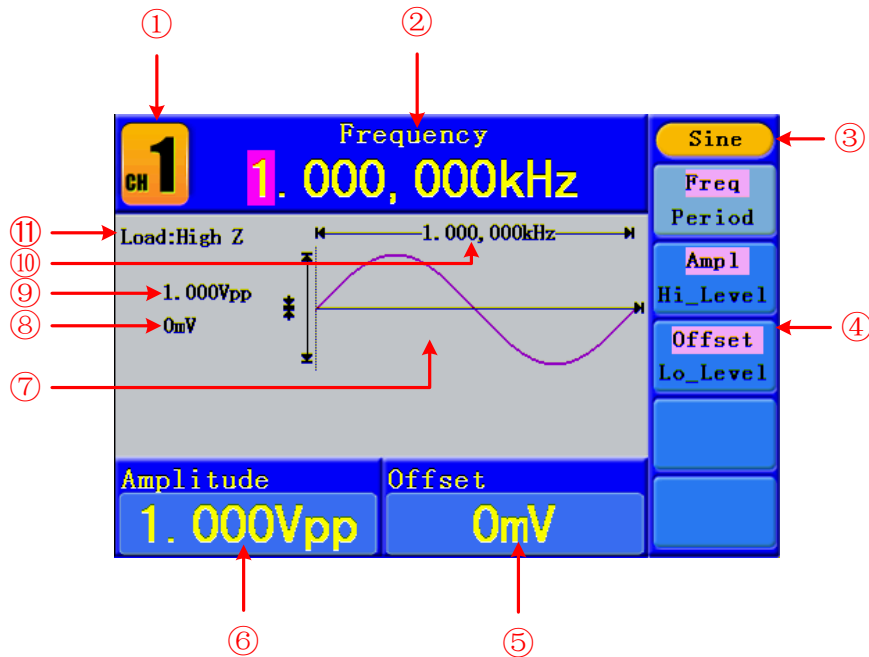

Figure 4-3 User interface (take Sine for instance)

- | |
|---|
| ① Current channel |
| ② Parameter 1, display parameter and edit the focused parameter |
| ③ Current signal type or mode |
| ④ The setting menu of current signal or mode |

- ⑤ Parameter 3, display parameter and edit the focused parameter
 - ⑥ Parameter 2, display parameter and edit the focused parameter
 - ⑦ Display current waveform
 - ⑧ Offset/low level, depends on the highlighted menu item on the right
 - ⑨ Amplitude/high level, depends on the highlighted menu item on the right
 - ⑩ Frequency/period, depends on the highlighted menu item on the right
 - ⑪ Load, High Z represents high resistance
-

General Inspection

After you get a new Waveform Generator, it is recommended that you should make a check on the instrument according to the following steps:

1. Check whether there is any damage caused by transportation.

If it is found that the packaging carton or the foamed plastic protection cushion has suffered serious damage, do not throw it away first till the complete device and its accessories succeed in the electrical and mechanical property tests.

2. Check the Accessories

The supplied accessories have been already described in the *Appendix A: Enclosure* of this Manual. You can check whether there is any loss of accessories with reference to this description. If it is found that there is any accessory lost or damaged, please get in touch with the distributor of Lilliput responsible for this service or the Lilliput's local offices.

3. Check the Complete Instrument

If it is found that there is damage to the appearance of the instrument, or the instrument can not work normally, or fails in the performance test, please get in touch with the Lilliput's distributor responsible for this business or the Lilliput's local offices. If there is damage to the instrument caused by the transportation, please keep the package. With the transportation department or the Lilliput's distributor responsible for this business informed about it, a repairing or replacement of the instrument will be arranged by the Lilliput.

Foot Stool Adjustment

Unfold the foot stools on the bottom of the generator, as ⑪ in *Figure 4-1*.

Power-On Check

AC Power Input Setting

Adopt 100 - 110 VAC or 220 - 230 VAC power source. Users should regulate the voltage scale of the **Power Switch** according to the standards in their own country (see *Figure 4-2*) at the rear panel and use an appropriate fuse.

Voltage	Fuse
110 V	125 V, F4AL
220 V	250 V, F2AL

To change the voltage scale of the instrument, do the following steps:

- (1) Turn off the power button at the front panel and remove the power cord.
- (2) Check if the fuse installed before leaving factory (250 V, F2AL) can match with the selected voltage scale; if not, pry the cover open using a straight screwdriver (see ② in *Figure 4-2*), change the fuse.
- (3) Regulate the **Power Switch** to the desired voltage scale.

Power On

- (1) Connect the instrument to the AC supply using the supplied power cord.



Warning:

To avoid electric shock, the instrument must be grounded properly.

- (2) Press down the **power button** at the front panel, the screen shows the boot screen.

5. Front Panel Operation

This chapter will deal with the following topics mainly:

- **How to Set Channels**
- **How to Output Sine Signals**
- **How to Output Square Signals**
- **How to Output Ramp Signals**
- **How to Output Pulse Signals**
- **How to Output Noise Signals**
- **How to Output Arbitrary Signals**
- **How to Output DC**
- **How to Generate the Modulated Waveform**
- **How to Generate Sweep**
- **How to Generate Burst**
- **How to Save and Recall**
- **How to Set the Utility Function**
- **How to Use Built-in Help**

To set channels

- **To Switch Channels for Display**

Press **CH1/2** button to switch channel displayed on the screen between CH1 and CH2.

- **To Display/Edit Both Channels**

Press **Both** button to display the parameters of both channels.

To switch channel: Press **CH1/2** to switch the editable channel.

To select waveform: Press **Waveform selection buttons** to select waveform of current channel.

To select parameter: Press **F2** - **F5** to choose the **Parameter 1** to **Parameter 4**; Press it again to switch the current parameter such as Frequency/Period.

To edit parameter: Turn the **knob** to change the value of cursor position. Press **←/→** direction key to move the cursor. (The number keys can not be used to input.)

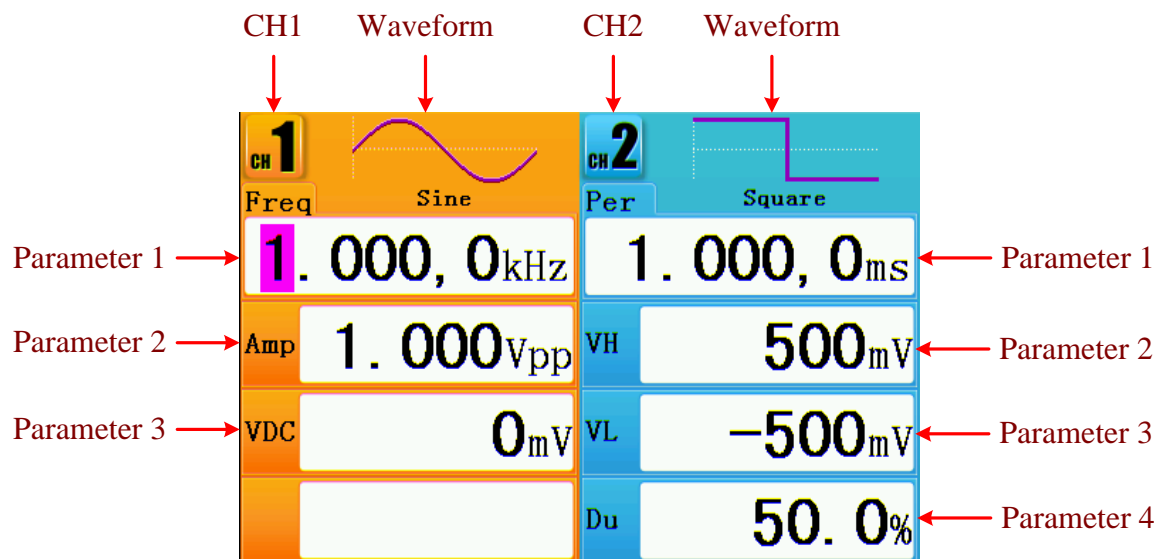

Figure 5-1: The User Interface of **Both** button

- **To Turn On/Off Output of Channels**

Press **CH1** or **CH2** to turn on/off output of the corresponding channel. The indicator will be lighted when the corresponding channel is tuned on.

- **Channel Copy**

(1) In signal output interface, press the **knob** on the front panel to enter Channel Copy menu.

(2) Press **F1** to select From CH2 To CH1, or press **F2** to select From CH1 To CH2.

To set signals

The following describes how to set and output Sine, Square, Ramp, Pulse, Noise, Arbitrary, DC signals and copy channel.

To Output Sine Signals

Press  button to call the user interface of Sine signal, the Sine waveform parameters can be set by operating the Sine setting menu on the right.

The parameters of Sine waveform are: Frequency/Period, Amplitude/High Level, Offset/Low Level. You can operate the menu by using the menu selection buttons on the right.

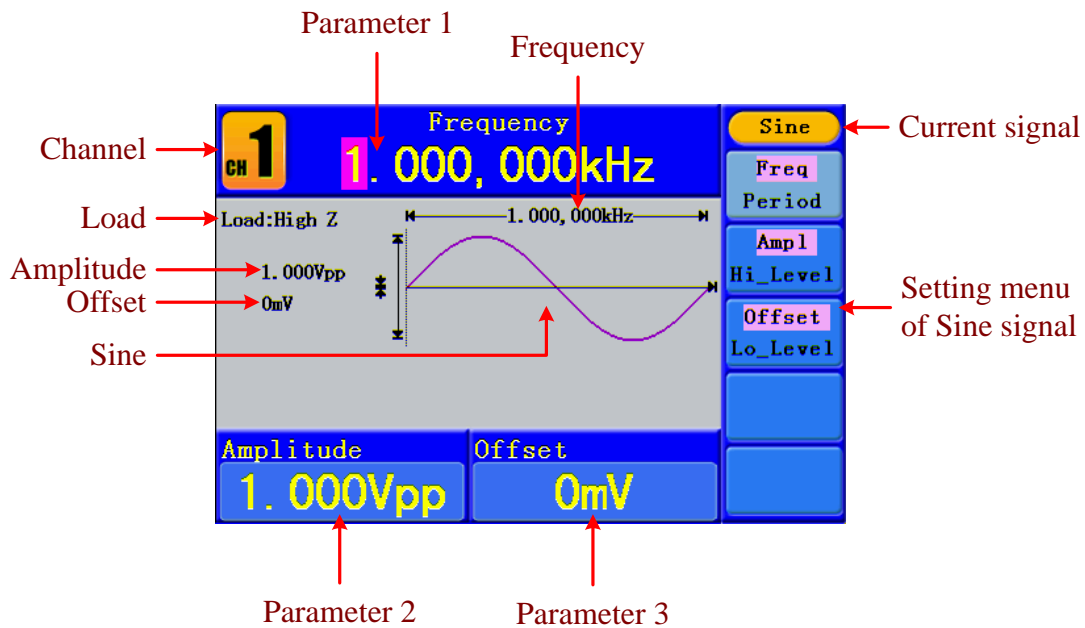



Figure 5-2: The User Interface of Sine Signal

To Set the Frequency/Period

Press **F1** button, the chosen menu item is highlighted, the focused parameter is displayed in **Parameter 1**. Press **F1** button to switch between Frequency/Period.

Two methods to change the chosen parameter:

- Turn the **knob** to change the value of cursor position. Press  direction key to move the cursor.
- Press a number key in the front panel, an input box will pop up; keep going to input the value. Press  direction key to delete the last number. Press **F1** - **F3** to choose the unit, or press **F4** to go to next page and choose other units. Press **F5** to cancel the input.

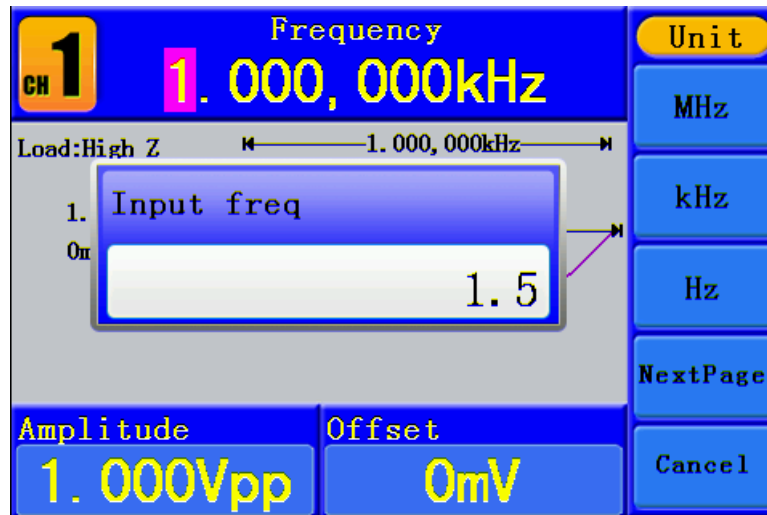

Figure 5-3: Set the frequency using number keys

To Set the Amplitude

Press **F2**, confirm whether the "Ampl" menu item is highlighted; if not, press **F2** to switch into "Ampl". In **Parameter 2**, a cursor appears under the value of amplitude. Use the **knob** or the number keys to set the desired value.

To Set the Offset

Press **F3**, confirm whether the "Offset" menu item is highlighted; if not, press **F3** to switch into "Offset". In **Parameter 3**, a cursor appears under the value of offset. Use the **knob** or the number keys to set the desired value.

To Set the High Level

Press **F2**, confirm whether the "Hi_Level" menu item is highlighted; if not, press **F2** to switch into "Hi_Level". In **Parameter 2**, a cursor appears under the value of amplitude. Use the **knob** or the number keys to set the desired value.

To Set the Low Level

Press **F3**, confirm whether the "Lo_Level" menu item is highlighted; if not, press **F3** to switch into "Lo_Level". In **Parameter 3**, a cursor appears under the value of offset. Use the **knob** or the number keys to set the desired value.

To Output Square Signals

Press  button to call the user interface of Square signal, the Square waveform parameters can be set by operating the Square setting menu on the right.

The parameters of Square waveform are: Frequency/Period, Amplitude/High Level, Offset/Low Level, Duty. You can operate the menu by using the menu selection buttons on the right.

To set the Frequency/Period, Amplitude/High Level, Offset/Low Level, please refer to *To Output Sine Signals* on page 12.

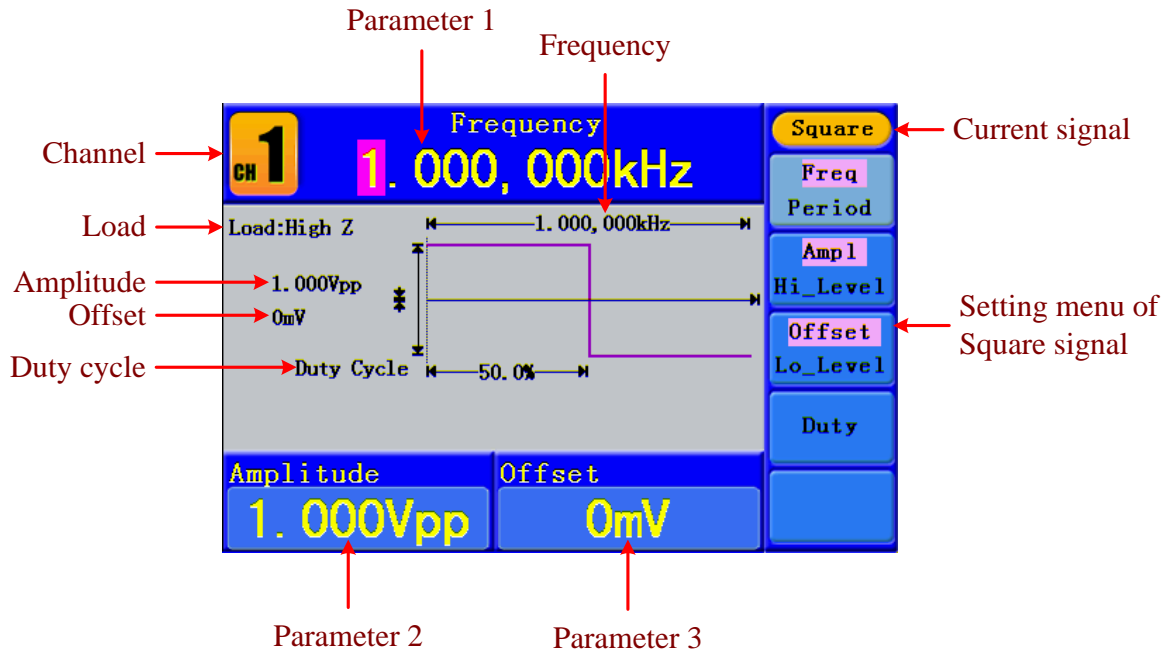

Figure 5-4: The User Interface of Square Signal

Term Explanation

Duty Cycle:

The percentage that the High Level takes up the whole Period.

To Set the Duty Cycle

- (1) Press **F4** button, the "Duty" menu item is highlighted, the current value of the Duty cycle is displayed in **Parameter 1**.
- (2) Turn the **knob** to change the value directly;
or press the number keys to input the desired value, press **F4** to choose "%".

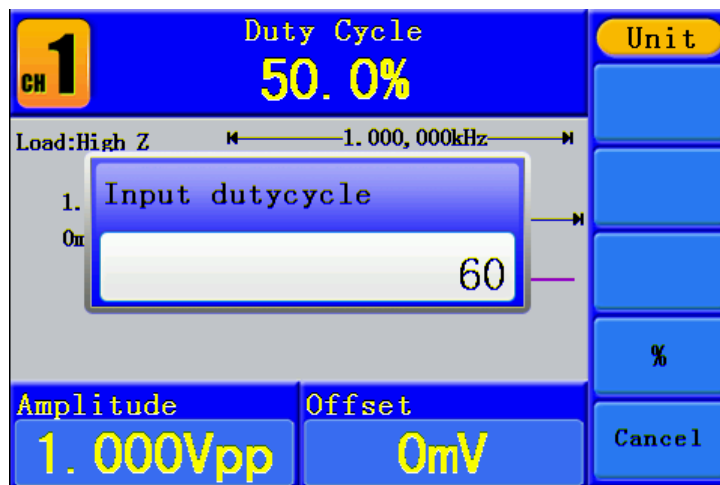



Figure 5-5: Set the Duty cycle of Square signal

To Output Ramp Signals

Press  button to call the user interface of Ramp signal, the Ramp waveform parameters can be set by operating the Ramp setting menu on the right.

The parameters of Ramp waveform are: Frequency/Period, Amplitude/High Level, Offset/Low Level, Symmetry. You can operate the menu by using the menu selection buttons on the right.

To set the Frequency/Period, Amplitude/High Level, Offset/Low Level, please refer to *To Output Sine Signals* on page 12.

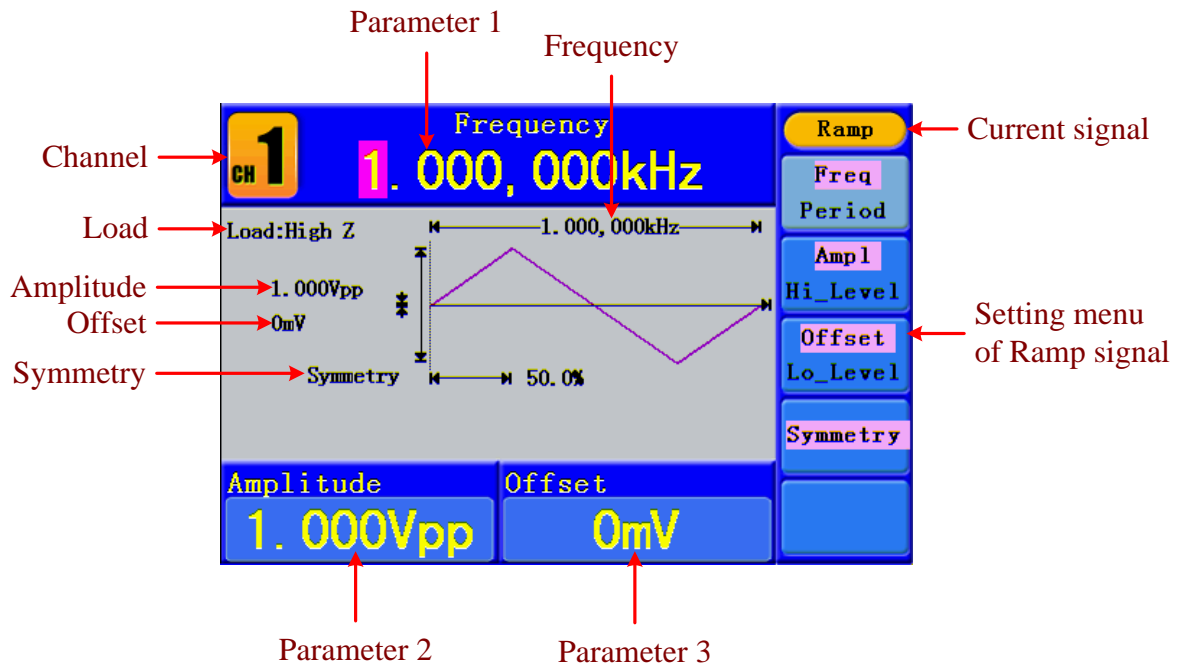

Figure 5-6: The User Interface of Ramp Signal

Term Explanation

Symmetry:

The percentage that the Rising Period takes up the whole Period.

To Set the Symmetry

- (1) Press **F4** button, the "Symmetry" menu item is highlighted, the current value of the symmetry is displayed in **Parameter 1**.
- (2) Turn the **knob** to change the value directly;
or press the number keys to input the desired value, press **F4** to choose "%".

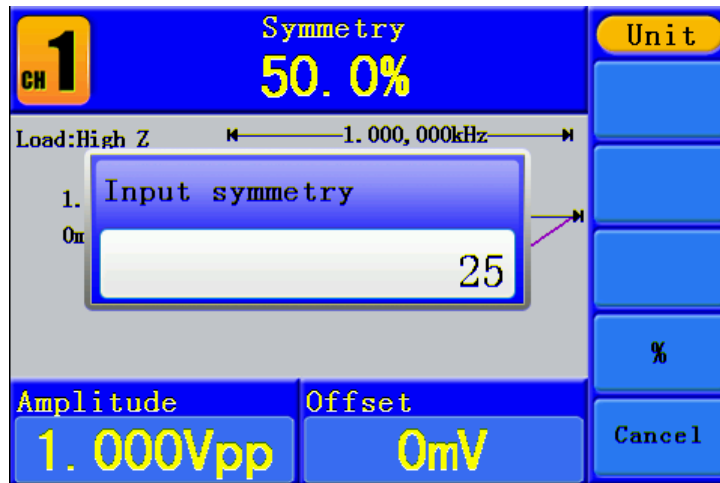

Figure 5-7: Set the symmetry of Ramp signal

To Output Pulse Signals

Press \square button to call the user interface of Pulse signal, the Pulse waveform parameters can be set by operating the Pulse setting menu on the right.

The parameters of Pulse waveform are: Frequency/Period, Amplitude/High Level, Offset/Low Level, Pulse Width/Duty. You can operate the menu by using the menu selection buttons on the right.

To set the Frequency/Period, Amplitude/High Level, Offset/Low Level, please refer to *To Output Sine Signals* on page 12.

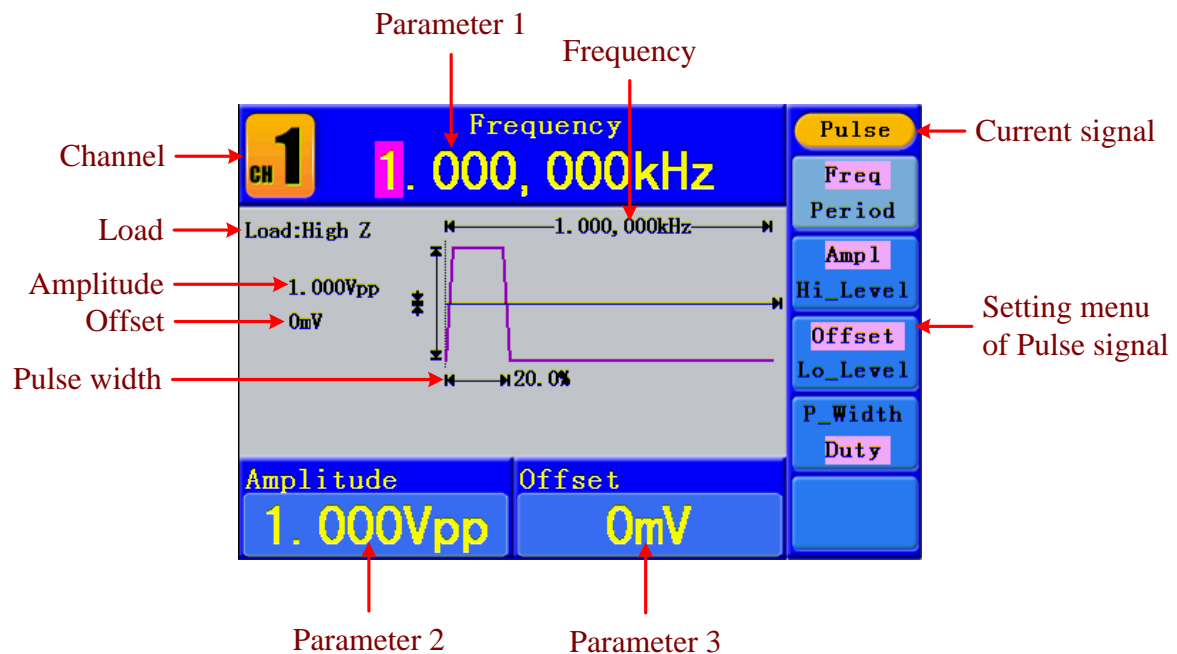

Figure 5-8: The User Interface of Pulse Signal

Term Explanation

Pulse Width:

There are two kinds of Pulse Width—positive and negative.

Positive Pulse Width is the time span between thresholds of 50% of the rising edge amplitude to the next 50% of the falling edge amplitude.

Negative Pulse Width is the time span between thresholds of 50% of the falling edge amplitude to the next 50% of the rising edge amplitude.

Pulse Width is determined by Period and Duty Cycle;
the formula is: $\text{Pulse Width} = \text{Period} * \text{Duty Cycle}$.

To Set the Pulse Width / Duty Cycle

- (1) Press **F4** button, the chosen menu item is highlighted, the focused parameter is displayed in **Parameter 1**. Press **F4** to switch between Pulse Width/Duty.
- (2) Turn the **knob** to change the value directly;
or press the number keys to input the desired value and choose the unit.

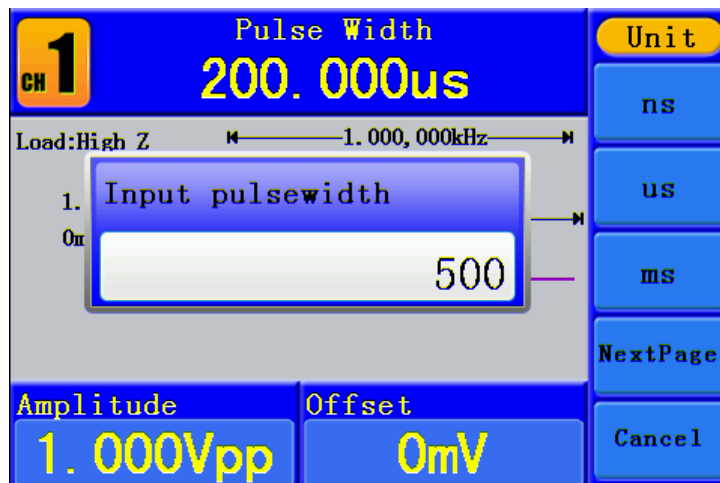



Figure 5-9: Set the Pulse Width of Pulse signal

To Output Noise Signals

The noise signal which the generator output is white noise. Press  button to call the user interface of Noise signal, the Noise waveform parameters can be set by operating the Noise setting menu on the right.

The parameters of Noise waveform are: **Amplitude/High Level**, **Offset/Low Level**. You can operate the menu by using the menu selection buttons on the right.

To set the **Amplitude/High Level**, **Offset/Low Level**, please refer to *To Output Sine Signals* on page 12.

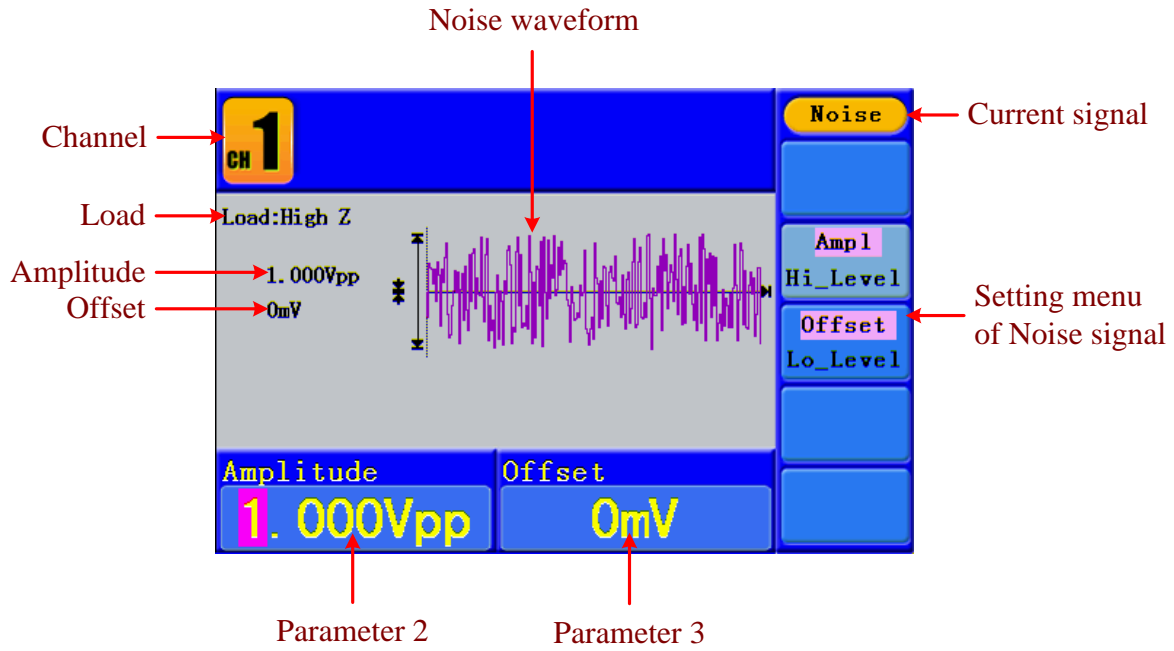



Figure 5-10: The User Interface of Noise Signal

To Output Arbitrary Signals

Press  button to call the user interface of Arbitrary signal, the Arbitrary waveform parameters can be set by operating the Arbitrary setting menu on the right.

The menu items of Arbitrary waveform are: Frequency/Period, Amplitude/High Level, Offset/Low Level, Built-in Waveform, Editable Waveform. You can operate the menu by using the menu selection buttons on the right.

To set the Frequency/Period, Amplitude/High Level, Offset/Low Level, please refer to *To Output Sine Signals* on page 12.

The Arbitrary signal consists of two types: the system built-in waveform and the user-definable waveform.

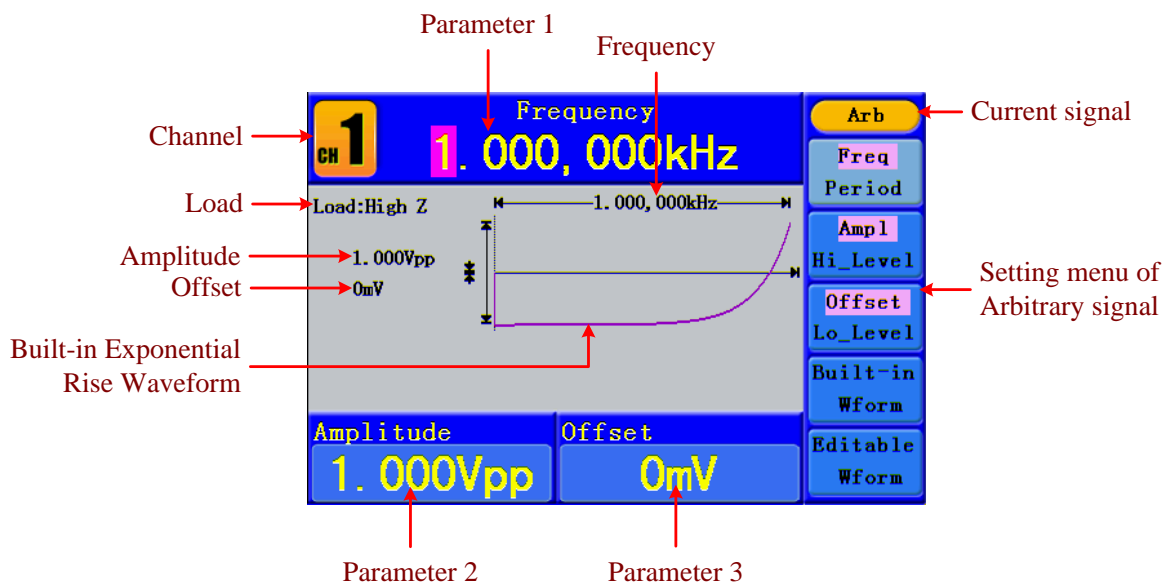



Figure 5-11: The User Interface of Arbitrary Signal

To Select the Built-in Waveform

There are 45 built-in Arbitrary waveforms.

Steps for selecting the built-in waveform:

- (1) Press  button, then press **F4** to enter the **Built-in Wform** menu.
- (2) Press **F1** - **F4** to select **Common**, **Maths**, **Window** or **Others**. E.g. select **Maths** to enter the following interface.

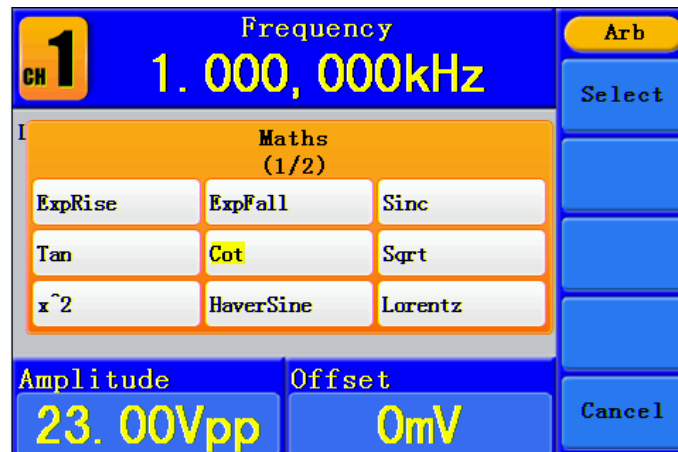

- (3) Turn the **knob** or press  direction key to choose the desired waveform. E.g. select **ExpRise**. Press **F1** to output the Exponential Rise waveform.

Built-in Waveform Table

Name	Explanation
Common	
StairD	Stair-down waveform
StairU	Stair-up waveform
StairUD	Stair-up and stair-down waveform
Trapezia	Trapezoid waveform
RoundHalf	RoundHalf wave
AbsSine	Absolute value of a Sine
AbsSineHalf	Absolute value of half a Sine
SineTra	Sine transverse cut
SineVer	Sine vertical cut
NegRamp	Negative ramp
AttALT	Gain oscillation curve
AmpALT	Attenuation oscillation curve
CPulse	Coded pulse
PPulse	Positive pulse
NPulse	Negative pulse
Maths	
ExpRise	Exponential rise function
ExpFall	Exponential fall function

5.Front Panel Operation



Sinc	Sinc function
Tan	Tangent
Cot	Cotangent
Sqrt	Square root
XX	Square function
HaverSine	HaverSine function
Lorentz	Lorentz function
In	Natural logarithm function
Cubic	Cubic function
Cauchy	Cauchy distribution
Besselj	Bessell function
Bessely	Besselll function
Erf	Error function
Airy	Airy function
Windows	
Rectangle	Rectangle window
Gauss	Gauss distribution
Hamming	Hamming window
Hann	Hanning window
Bartlett	Bartlett window
Blackman	Blackman window
Laylight	Laylight window
Triang	Triangle window (Fejer window)
Others	
DC	DC signal
Heart	Heart signal
Round	Round signal
LFMPulse	Linear FM pulse
Rhombus	Rhombus signal
Cardiac	Cardiac signal

The User-Definable Waveform



Press  button and press **F5** to select "Editable Wform".

Menu item	Instruction
Create Wform	Create a new waveform.
Select Wform	Select the waveform stored in internal storage (FLASH) or USB device (USBDEVICE).
Edit Wform	Edit the stored waveform.



How to Create a New Waveform

- (1) **Enter the operation menu:** Press  → Editable Wform → Create Wform.
- (2) **Set the number of waveform points:** Press **F1** to select "Wform Points", turn the knob or press the number keys to input the desired value and choose the unit. X1, XK, XM respectively represent 1, 1000, 1000,000. The waveform points range is 2 - 1000,000.
- (3) **Set the interpolation:** Press **F2** to switch between On/Off. If you choose On, the points will be connected with beelines; otherwise, the voltages between two consecutive points will not change, and the waveform looks like a step-up one.
- (4) **Edit the waveform points:** Press **F3** to enter the operation menu.
 - Press **F1** to choose "Points", input the number of the point to be edited.
 - Press **F2** to choose "Voltage", input the voltage for the current point.
 - Repeat the step above, set all the points to your needs.
 - Press **F4** to choose "Store", enter the file system. If a USB device is connected, press  direction key to select the storage. "USBDEVICE" is the USB device storage, "FLASH" is the internal storage. Choose Next level, enter the desired storage path, choose Save, an input keyboard pops up, input the file name, and then choose DONE.

How to Select a Stored Waveform

- (1) **Enter the operation menu:** Press  → Editable Wform → Select Wform.
- (2) Enter the storage path of the desired waveform file. Turn the knob or press  direction key to select the desired waveform file.
- (3) Choose Recall output.

How to Edit a Stored Waveform

- (1) **Enter the operation menu:** Press  → Editable Wform → Edit Wform.
- (2) Enter the storage path of the desired waveform file. Turn the knob or press  direction key to select the desired waveform file.
- (3) Choose Recall suppress.

How to Delete a Stored Waveform

- (1) Press Save function button to enter the file system.
- (2) Enter the storage path of the desired waveform file. Turn the knob or press  direction key to select the desired waveform file.
- (3) Choose Delete.

To Output DC

- (1) Press **CH1/2** to select the channel that you want to output DC.
- (2) Press  button, then press **F4** to enter the **Built-in Wform** menu.
- (3) Press **F4** to select **Others**. Select **DC**. Press **F1** to output DC.
- (4) Press **F3**, confirm whether the "**Offset**" menu item is highlighted; if not, press **F3** to switch into "**Offset**". In **Parameter 3**, a cursor appears under the value of offset. Use the **knob** or the number keys to set the desired value and choose the unit.

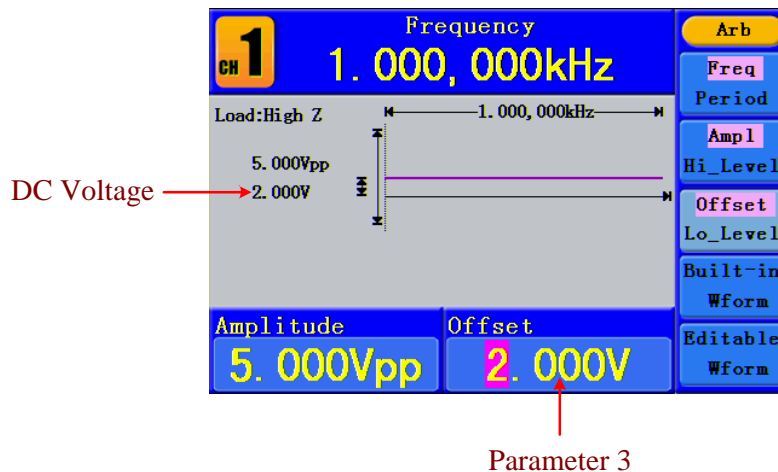

Figure 5-12: The DC Setting Interface

To recall wave file

This function can read the waveform file with suffix of (*.ota) which is cut from SDS series oscilloscope manufactured by OWON and saved to USB device or cut by the software of OWON oscilloscope. Then ARB waveform generators can output the same signal as the cut wave.

Use SDS Series oscilloscope manufactured by OWON to cut wave:

- (1) Connect USB device to SDS series oscilloscope.
- (2) Press **Save** to call out the save menu.
- (3) Press the H1 button, the Type menu will display at the left of the screen, turn the M knob to choose **Cut Wave** for type.
- (4) Move cursor1 and cursor2 to choose the range of wave to be cut.
- (5) Press the H2 button, and the input keyboard will pop up. The default name is the current system date. Turn M knob to choose the keys, and press M knob to input the chosen keys. Choose and press **Enter** key of the keyboard to end the input and store the file with the current name to USB device.

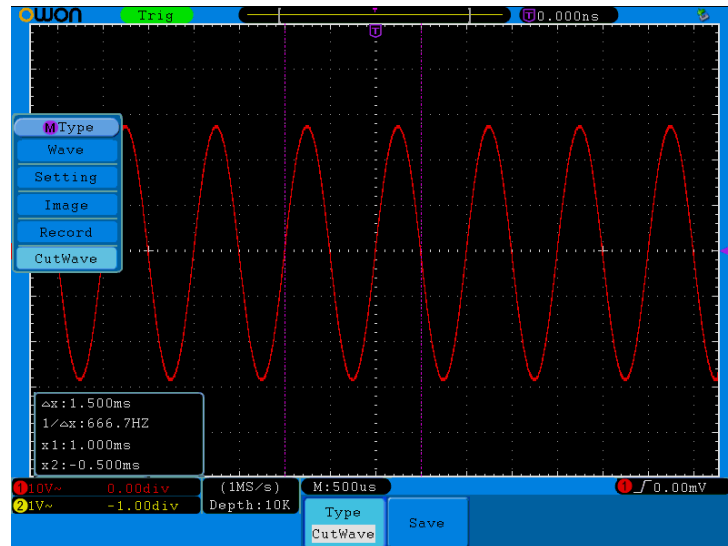



Figure 5-13: Cut Wave

Use waveform generators to recall wave:

- (1) **Enter the operation menu:** Press  → Editable Wform → SelectWform. Enter the following interface:

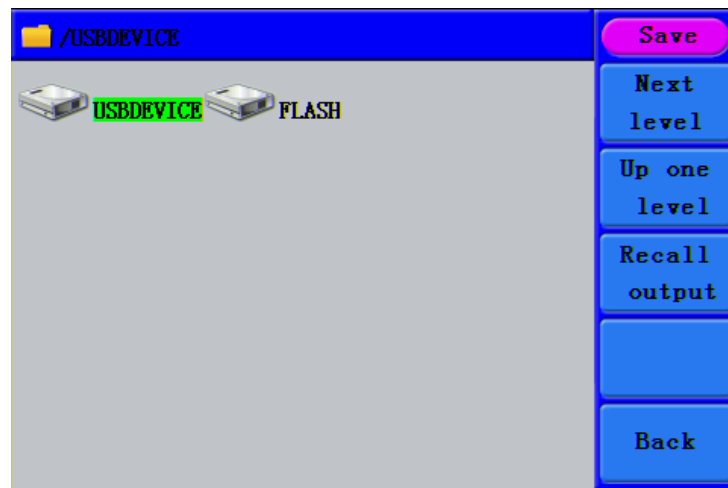



Figure 5-14: Choose storage device

- (2) Select **USBDEVICE**, enter The Next Level. Turn the **knob** or press  direction key to select the saved **example.ota** waveform file.

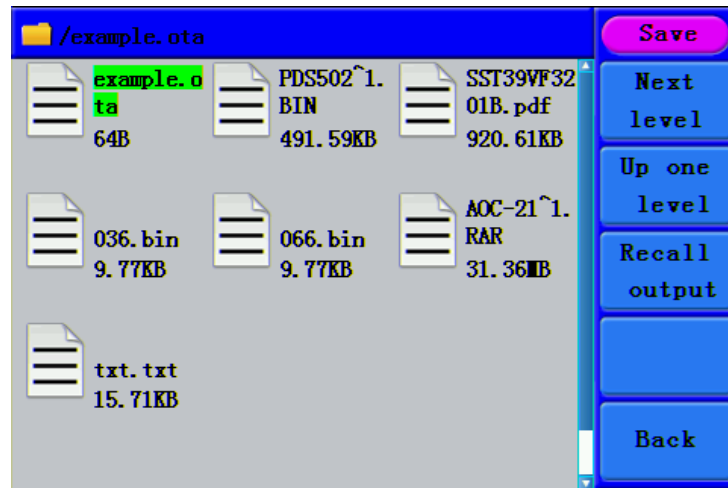

Figure 5-15: choose the .ota file

(3) Choose Recall output, and the tip “Read file successfully” will show on the interface.

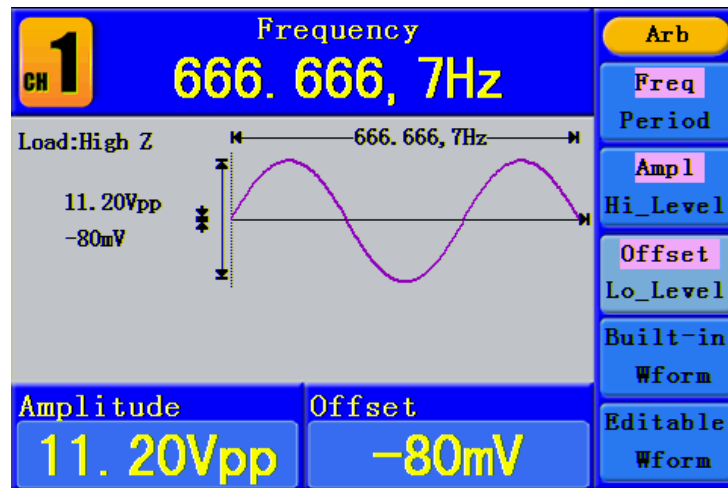

Figure 5-16: Read file

Tips:

1. Normally the frequency, amplitude, and offset of the recalled wave are the same as the wave being cut, but when the frequency, amplitude, and offset are set out of the limit range, then the generator would use the current parameter, which leads to the recalled wave not totally the same as the cut wave.
2. The max data number of AG1012F AG1022F ARB is 8192. When the wave cut from oscilloscope contains data number more than 8192, AG1012F and AG1022F will compress data. On the contrary if the data number is less than 8192, AG1012F and AG1022F will use linear interpolation.
3. The max data number of AG2052F, AG2062F ARB is 1000000. When the wave cut from oscilloscope contains data number more than 1000000, generators will compress data. On the contrary if the data number is less than 1000000, generators will use linear interpolation.

To Generate the Modulated Waveform

Modulation function is only used for CH1. Press the **Mod** button, then press **F1** to select **Mod** to generate modulated waveform. The waveform generator can modulate waveform using AM, FM, PM, FSK and PWM (only in AG2052F and AG2062F). To turn off

the modulation, press the **Mod** button.

AM (Amplitude Modulation)

The modulated waveform consists of two parts: the Carrier Waveform and the Modulating Waveform. The Carrier Waveform can only be Sine. In AM, the amplitude of the Carrier Waveform varies with the instantaneous voltage of the modulating waveform. The user interface of the AM is shown as below.

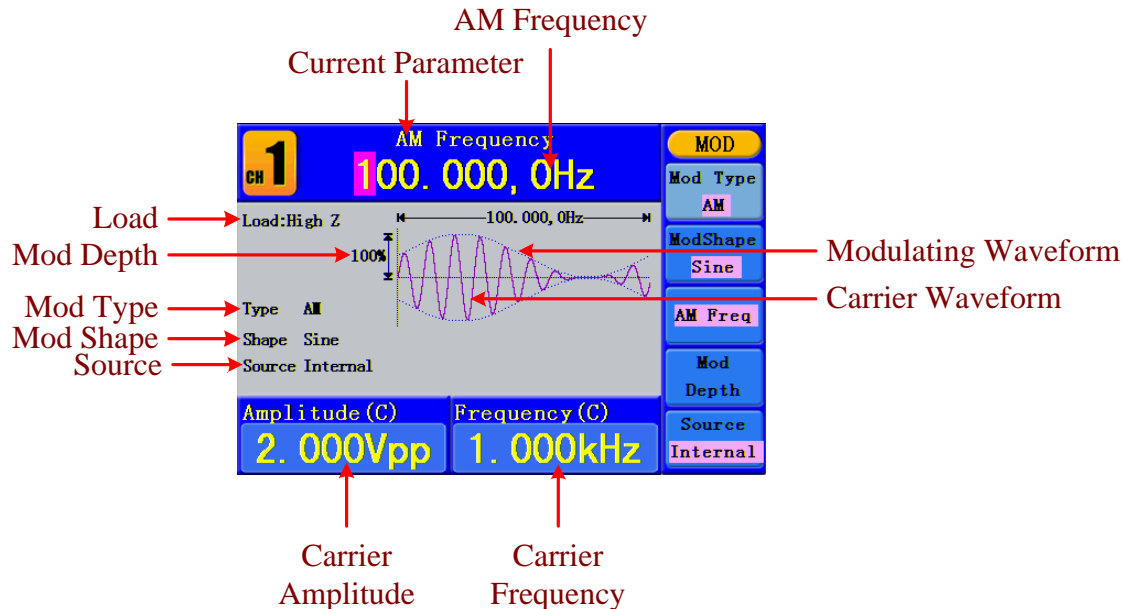



Figure 5-17: The User Interface of AM

How to set the parameters of AM

- (1) Press **Mod** function button, then press **F1** to select **Mod**.
- (2) Press **F1** to switch **Mod Type** to **AM**. If the Carrier Waveform is not Sine, the system will switch it to Sine automatically.
- (3) Press  button to display the waveform and parameters of the Carrier Waveform. You can change the parameters, please refer to *To Output Sine Signals* on page 12. Press  button again to return to the Modulation mode interface.
- (4) Press **F5** to select the source. If the source is **External**, use the **Ext Mod In** connector in the rear panel to input the external signal, the setting of AM is finished. If you choose **Internal**, continue to the steps below.
- (5) Press **F2** to choose **Mod Shape**, you can choose Sine, Square or Ramp.
- (6) Press **F3** to set **AM Frequency**. The range is 2 mHz - 20 kHz (Internal source only).
- (7) Press **F4** to set **Mod Depth**. The range is 0% - 100%.

Term Explanation

AM Frequency:

The frequency of modulating waveform.

Mod Depth:

The Amplitude Range of modulating waveform. In the 0% Modulation, the output amplitude is the half of the set one. In the 100% Modulation, the output amplitude is the same with the set one. For an external source, the depth of AM is controlled by the voltage level of the signal connected to the **Ext Mod In** connector in the rear panel. +5V corresponds to the currently set depth 100%.

FM (Frequency Modulation)

The modulated waveform consists of two parts: the Carrier Waveform and the Modulating Waveform. The Carrier Waveform can only be Sine. In FM, the frequency of the Carrier Waveform varies with the instantaneous voltage of the modulating waveform. The user interface of the FM is shown as below.

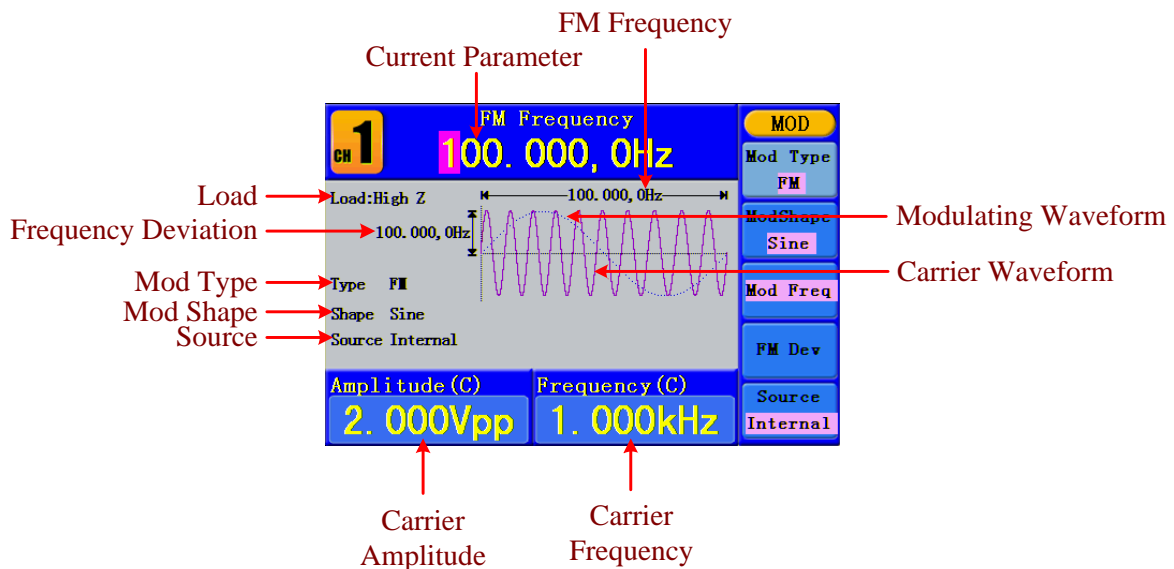

Figure 5-18: The User Interface of FM

How to set the parameters of FM

- (1) Press **Mod** function button, then press **F1** to select **Mod**.
- (2) Press **F1** to switch **Mod Type** to **FM**. If the Carrier Waveform is not Sine, the system will switch it to Sine automatically.
- (3) Press \sim button to display the waveform and parameters of the Carrier Waveform. You can change the parameters, please refer to *To Output Sine Signals* on page 12. Press \sim button again to return to the Modulation mode interface.
- (4) Press **F5** to select the source. If the source is **External**, use the **Ext Mod In** connector in the rear panel to input the external signal, then skip ahead to step (6). If you choose **Internal**, continue to the steps below.

- (5) Press **F2** to choose **Mod Shape**, you can choose Sine, Square or Ramp.
- (6) Press **F3** to set **Mod Frequency**. The range is 2 mHz - 20 kHz (Internal source only).
- (7) Press **F4** to set **FM Deviation**. The Deviation should be less than the Carrier Waveform Frequency.

Note:

The Sum of the Deviation and the Carrier Frequency should be equal to or less than maximum frequency of the selected function plus 1 kHz.

For an External Source, the Deviation is controlled by the voltage Level of the signal connected to the **Ext Mod In** connector in the rear panel. +5 V corresponds to the selected Deviation and -5 V to the negative selected Deviation.

PM (Phase Modulation)

The modulated waveform consists of two parts: the Carrier Waveform and the Modulating Waveform. The Carrier Waveform can only be Sine. In PM, the phase of the Carrier Waveform varies with the instantaneous voltage level of the modulating waveform. The user interface of the PM is shown as below.

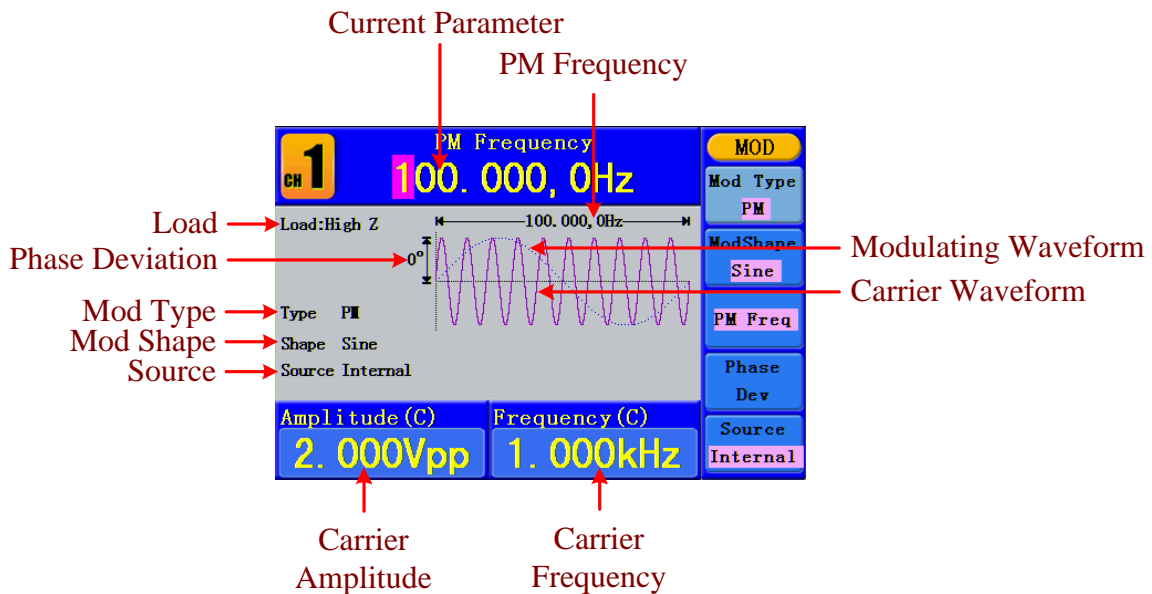



Figure 5-19: The User Interface of PM

How to set the parameters of PM

- (1) Press **Mod** function button, then press **F1** to select **Mod**.
- (2) Press **F1** to switch **Mod Type** to **PM**. If the Carrier Waveform is not Sine, the system will switch it to Sine automatically.
- (3) Press  button to display the waveform and parameters of the Carrier Waveform. You can change the parameters, please refer to *To Output Sine Signals* on page 12. Press  button again to return to the Modulation mode interface.

- (4) Press **F5** to select the source. If the source is **External**, use the **Ext Mod In** connector in the rear panel to input the external signal, then skip ahead to step (6). If you choose **Internal**, continue to the steps below.
- (5) Press **F2** to choose **Mod Shape**, you can choose Sine, Square or Ramp.
- (6) Press **F3** to set **PM Frequency**. The range is 2 mHz - 20 kHz (Internal source only).
- (7) Press **F4** to set **Phase Deviation**. The Phase Deviation between the Modulating Waveform and the Carrier Waveform ranging from 0° to 180°.

FSK (Frequency Shift Keying)

The FSK Modulation is a modulation method, the output frequency of which switches between two the pre-set frequencies (Carrier Waveform Frequency and the Hop Frequency). The Frequency of the Output Frequency switch between the carrier waveform frequency and the Hop frequency is called the **FSK rate**. The frequency by which the output frequency switch from each other is determined by the Internal Frequency generator or the Signal Voltage Level offered by the **Ext Trig/Burst/Fsk In** connector in the rear panel. The Carrier Waveform can only be Sine. The user interface of the FSK is shown as below.

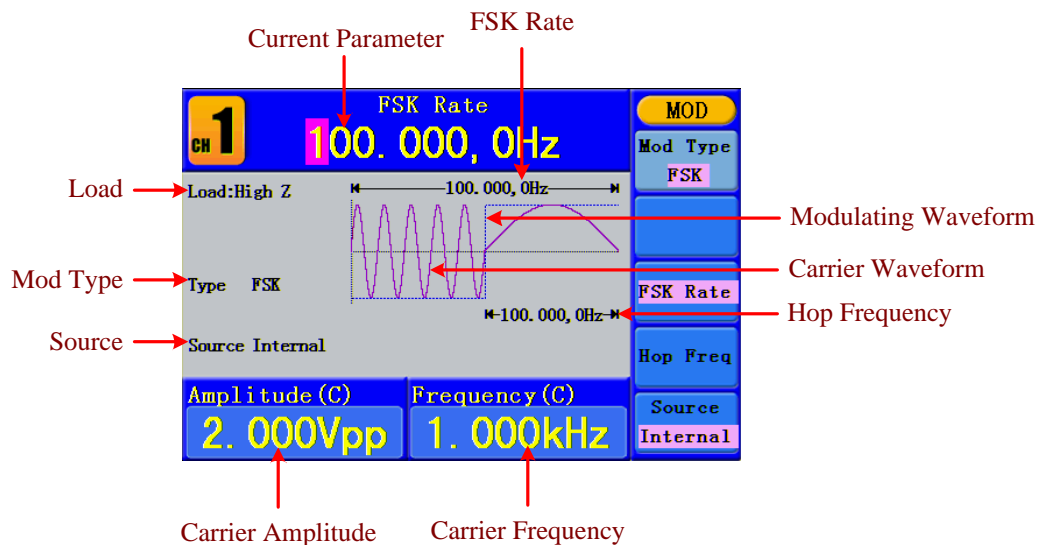

Figure 5-20: The User Interface of FSK

How to set the parameters of FSK

- (1) Press **Mod** function button, then press **F1** to select **Mod**.
- (2) Press **F1** to switch **Mod Type** to **FSK**. If the Carrier Waveform is not Sine, the system will switch it to Sine automatically.
- (3) Press **~** button to display the waveform and parameters of the Carrier Waveform. You can change the parameters, please refer to *To Output Sine Signals* on page 12. Press **~** button again to return to the Modulation mode interface.
- (4) Press **F5** to select the source. If the source is **External**, use the **Ext Trig/Burst/Fsk In** connector in the rear panel to input the external signal, then skip ahead to step (5).

If you choose **Internal**, continue to the steps below.

- (5) Press **F3** to set **FSK Rate**. The range is 2 mHz - 100 kHz (Internal source only).
- (6) Press **F4** to set **Hop Frequency**. The range is 2 mHz - 25kHz.

Term Explanation

FSK Rate:

The frequency at which the output frequency shifts between the carrier frequency and the Hop frequency (Internal Modulation only).

PWM (Pulse Width Modulation) (only in AG2052F and AG2062F)

The modulated waveform consists of two parts: the Carrier Waveform and the Modulating Waveform. PWM can only be used for pulse modulation, so the Carrier Waveform must be Pulse. In PWM, the width of the Carrier Waveform (Pulse) varies with the instantaneous voltage of the modulating waveform.

How to set the parameters of PWM

- (1) Press **Mod** function button, then press **F1** to select **Mod**.
- (2) Press **F1** to switch **Mod Type** to **PWM**. If the Carrier Waveform is not Pulse, the system will switch it to Pulse automatically.
- (3) Press **↵** button to display the waveform and parameters of the Carrier Waveform. You can change the parameters, please refer to *To Output Pulse Signals* on page 16. Press **↵** button again to return to the Modulation mode interface.
- (4) Press **F5** to select the source. If the source is **External**, use the **Ext Mod In** connector in the rear panel to input the external signal, then skip ahead to step (6). If you choose **Internal**, continue to the steps below.
- (5) Press **F2** to choose **Mod Shape**, you can choose Sine, Square or Ramp.
- (6) Press **F3** to set **Mod Frequency**. The range is 2 mHz - 20 kHz (Internal source only).
- (7) Press **F4** to set **Width Deviation/Duty Deviation** (depends on the **P_Width/Duty** menu item of the Pulse setting menu when you exit the Modulation mode). The maximum range of the Duty Deviation is the smaller one in [Pulse Duty, 1-Pulse Duty]. The maximum range of the Width Deviation is Pulse Width.

To Generate Sweep

Sweep function is only used for CH1. In the frequency sweep mode, the generator "steps" from the start frequency to the stop frequency at the sweep rate you specify. Sweep can be generated by Sine, Square or Ramp Waveforms.

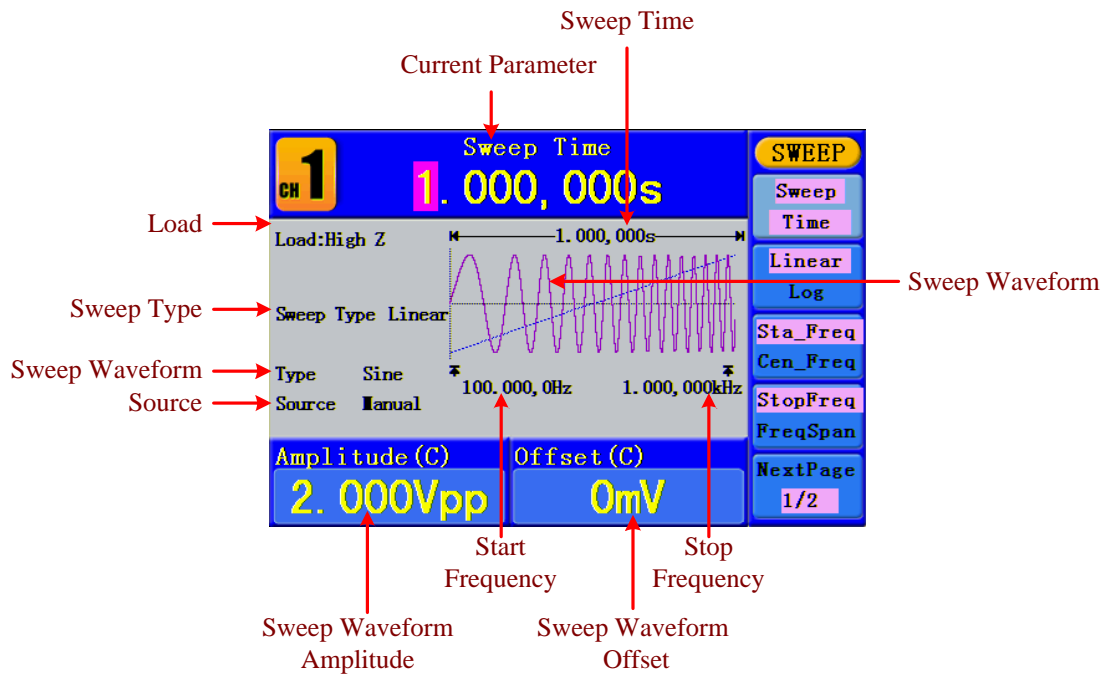







Figure 5-21: The User Interface of Sweep Mode

How to set the parameters of Sweep

- (1) When the output signal is Sine, Square or Ramp waveform, press the **Mod** button, then press **F2** to select **Sweep** to enter the Sweep mode.
- (2) Press ,  or  button to choose the waveforms. Take Sine for instance, press  to display the waveform and parameters. You can change the parameters, please refer to *To set signals* on page 12. Press  button again to return to the Sweep mode interface.
- (3) Press **F1** to set **Sweep Time**, the Time Span of the Sweep for which the Frequency changes from the Start Frequency to Stop Frequency.
- (4) Press **F2** to select the Sweep Type. **Linear** means setting the Sweep with linear spacing; **Log** means setting the Sweep with logarithmic spacing.
- (5) Use **Start Freq** and **Stop Freq** or **Center Freq** and **Freq Span** to set the range of the frequency. Press **F3** to select **Sta_Freq** or **Cen_Freq**, and set the desired value.
- (6) Press **F4** to select **StopFreq** or **FreqSpan**, and set the desired value.
- (7) Press **F5** to select **NextPage**, press it again to enter the next page.
- (8) Press **F1** to select the source. **Internal** means using the internal source. **External** means using the **Ext Trig/Burst/Fsk In** connector in the rear panel to input the external signal. **Manual** means choosing manual trigger; in Sweep interface, press the **knob** on the front panel to trigger a Sweep.

To Generate Burst

Burst function is only used for CH1. Press the **Mod** button, then press **F3** to select **Burst** to generate versatile waveforms in burst. Burst can last for certain times of waveform cycle (N-Cycle Burst), or to be controlled by external gated signals (Gated Burst). Burst can apply to Sine, Square, Ramp, Pulse and Arbitrary waveforms (Noise can not be used).

Term Explanation

Burst:

Output Waveforms with set cycle times. Generally it is called BURST function within every Signal Generator.

N-Cycle Burst:

N-Cycle has specific number of waveform cycles, and every burst is activated by a trigger event.

Gated Burst:

Gated burst use external source to control burst as when to be activated.

Set the N-Cycle Burst

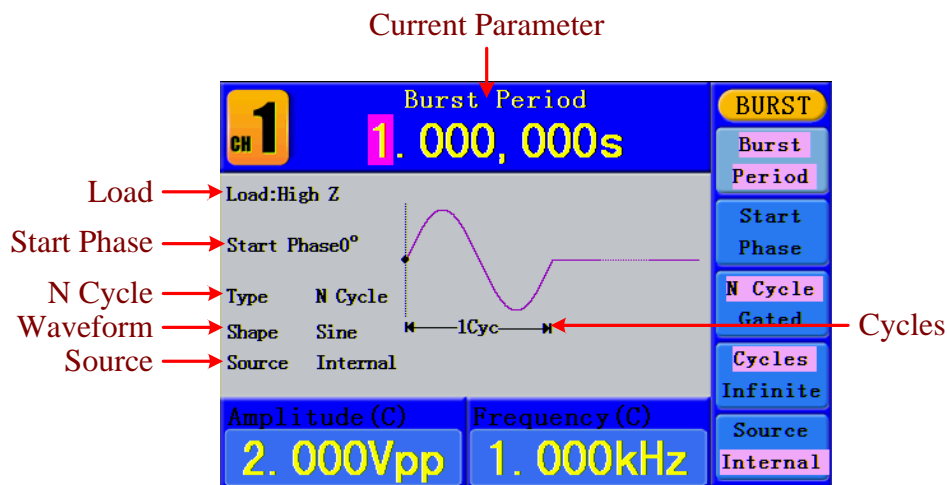









Figure 5-22: The User Interface of N-Cycle Burst

- (1) When the output signal is Sine, Square, Ramp, Pulse or Arbitrary waveform, press the **Mod** button, then press **F3** to select **Burst**.
- (2) Press , , ,  or  button to choose the waveform. Take Sine for instance, press  to display the waveform and parameters. You can change the parameters, please refer to *To set signals* on page 12. Press  button again to return to the Burst mode interface.
- (3) Press **F3** to switch to **N Cycle**.
- (4) Press **F1** to select **Burst Period**, set it to the desired value.

- (5) Press **F2** to select **Start Phase** (if current waveform is Pulse, skip this step), define the Start and the Stop Point in a waveform. The phase varies from -360° to $+360^\circ$. For an Arbitrary Waveform, 0° is the first waveform point.
- (6) Press **F4** to select **Cycles** or **Infinite**. Set the number of Waveform Cycle in an N-Cycle (from 1 to 50,000). If you choose **Infinite**, then a continuous waveform will be generated which will not stop until a trigger event happens (the **knob** on the front panel is pressed).

Note:

- If needed, Burst Period will increase to cater to the specific number of cycles.
- For an infinite-cycle Burst, External or Manual Trigger is needed to activate burst.

- (7) Press **F5** to select the source. **Internal** means using the internal source. **External** means using the **Ext Trig/Burst/Fsk In** connector in the rear panel to input the external signal. **Manual** means choosing manual trigger; in N-Cycle Burst interface, press the **knob** on the front panel to output a burst signal.

Set the Gated Burst

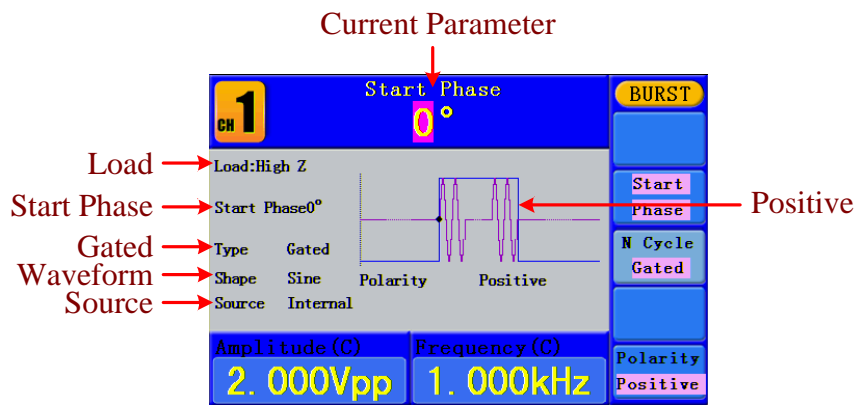









Figure 5-23: The User Interface of Gated Burst

- (1) When the output signal is Sine, Square, Ramp, Pulse or Arbitrary waveform, press the **Mod** button, then press **F3** to select **Burst**.
- (2) Press , , ,  or  button to choose the waveforms. Take Sine for instance, press  to display the waveform and parameters. You can change the parameters, please refer to *To set signals* on page 12. Press  button again to return to the Burst mode interface.
- (3) Press **F3** to switch to **Gated**.
- (4) Press **F2** to select **Start Phase**, define the Start and the Stop Point in a waveform. The phase varies from -360° to $+360^\circ$. For an Arbitrary Waveform, 0° is the first waveform point.
- (5) Press **F5** to switch between **Positive/Negative**. Set the Polarity for the Gated Signal.

To Save and Recall

Press **Save** function button to enter the file system.

To Use USB Storage

The storage location is divided into the internal storage (FLASH) and the USB device storage (USBDEVICE). When a USB device is connected, the storage menu will show "USBDEVICE" and "FLASH". Otherwise, the storage menu will show "FLASH" only.

- (1) **Install the USB device:** insert a USB device into the "⑰USB port" on the front panel in *Figure 4-1*, and the screen will show "Detect USB device". Press **Save** function button to enter the file system, the storage menu will show "USBDEVICE" and "FLASH".
- (2) **Enter the storage:** Turn the **knob** or press **◀/▶** direction key to choose the desired storage. Press **F1** to enter the chosen storage. Provide operations as **Next level**, **Up one level**, **New folder**, **Delete**, **Rename**, **Copy**, **Paste**.
- (3) **Remove the USB device:** Remove the USB device from the **USB port** on the front panel. The system will inform you "The USB device is removed", and the "USBDEVICE" in the storage menu will disappear.

To Edit the File Name

In file system, the user can edit the name of a file or a folder. When the system needs the user to input a name, an input keyboard will appear.



Figure 5-24: Edit the File Name

- (1) Turn the **knob** or press **◀/▶** direction key to move the cursor left and right in the keyboard. Press **F3** to switch between capital and small of the characters.
- (2) Press **F1** to enter the current character. Press **F2** to delete the last character .
- (3) Press **F4** to finish editing and save the file. Press **F5** to cancel the save operation.

Note: The length of file name is up to 15 characters.

To Set the Utility Function

Press **Utility** function key to enter the Utility Menu. You can set the parameters of the Generator such as: Display Parameter, Counter Parameter, Output Parameter and System Setting. Press **Utility** again to exit the Utility Menu.

To Set Display Parameter

To Set the Bright

- (1) Press **Utility** and choose **Disp Setup**, press **F1** to select **Bright**.
- (2) Turn the **knob** to change the value, press **◀/▶** direction key to move the cursor left and right; or press the number keys to input the desired value in percent, press **F4** to select the unit. The bright range is 0% - 100%.

To Set the Separator

The user can set the separator of the displayed parameter.

- (1) Press **Utility** and choose **Disp Setup**, press **F2** to select **Sep**.
- (2) Press **F2** to switch between **Comma**, **Space**, **Off**.

Take the Frequency parameter for instance:

Comma	Frequency 1. 000, 000kHz
Space	Frequency 1. 000 000kHz
Off	Frequency 1. 000000kHz

To Set the Screen Saver

The screen saver will run automatically if no operation is taken for any key within the set time. Press any button to resume.

- (1) Press **Utility** and choose **Disp Setup**, press **F3** to select **Scrn Svr**.
- (2) Press **F3** to switch between **On/Off**.
- (3) If **On** is selected, you can set the screen saver time. Turn the **knob** to change the value, press **◀/▶** direction key to move the cursor left and right; or press the number keys to input the desired time in minutes, press **F4** to select the unit. The screen saver time range is 1 - 999 minutes.

To Set the Counter

The counter can measure the signal with frequency form 100 mHz to 200 MHz.

The operation steps:

- (1) Press **Utility** and choose **Counter**.
- (2) Connect the signal to the connector [**Ref Clk/Counter In**] on the rear panel.
- (3) Press **F3** to choose **Set**, enter measurement setting menu.
 - **To set the coupling mode:** Press **F1** to switch **Coupling** as AC/DC.
 - **To set the sensitivity:** Press **F2** to switch **Sens** as Low/Middle/High. For low amplitude signal, the "Middle" or "High" sensitivity should be used. For low frequency signal with high amplitude and slower rising edge, low sensitivity is a better choice.
 - **To set the high frequency restrain on/off:** Press **F3** to switch **HFR** as ON/OFF. High frequency restrain is used for filtering the high frequency signal in measuring the low frequency signal, and improve the measure accuracy. To measure low frequency signal lower than 1 kHz, you should put on the high frequency restrain to filter the high frequency noise disturb. To measure high frequency signal higher than 1 kHz, you should put off the high frequency restrain.
 - **To set the trig level:** Press **F4** to choose **TrigLev**. Turn the **knob** to change the value, press **</>** direction key to move the cursor left and right; or press the number keys to input the desired value and choose the unit. The range of trig level is -2.5 V - 2.5 V.
 - Press **F5** to choose **Back** to previous menu, view the result.

After all the set was done, the counter will measure the signal according to the current set. If the reading is unsteady, please repeat the above step until it is steady.
- (4) Press **F1** to switch to view the measure result of **frequency** or **period**. Press **F2** to switch to view the measure result of **positive width** or **duty**.

To Set Output Parameter

To Set the Output Load

For either of **CH1 Output** and **CH2 Output** on the Front panel, the Generator has a built-in 50 Ω series impedance. If the actual load does not match the set one, the displayed amplitude and offset are incorrect. This function is used to match the displayed voltage with the expected one.

Steps for setting the Load of each channel:

- (1) Press **Utility** and choose **Output Setup**. Press **F1** to select **CH1Load**, or press **F2** to select **CH2Load**; press it again to select **HighZ** or *** Ω** ("*****" represents a value).
- (2) To change the load value, after selecting *** Ω** , turn the **knob** to change the value, press **</>** direction key to move the cursor left and right; or press the number keys to input the desired value. Press **F3** or **F4** to select the unit. The load range is 1 Ω - 10 k Ω .

Note:

For either of **CH1 Output** and **CH2 Output** on the Front panel, the waveform generator has a fixed 50Ω Series Impedance. No matter what Value the set parameter is, if the real load is different from the set one, the displayed voltage will not equal the real voltage.

To Set the Phase Deviation

You can set the phase deviation of the two channels.

- (1) Press **Utility** and choose **Output Setup**, press **F3** to select **PhaseDev**.
- (2) Press **F3** to switch between **On/Off**.
- (3) If **On** is selected, you can set the value of phase deviation. Turn the **knob** to change the value, press **◀/▶** direction key to move the cursor left and right; or press the number keys to input the desired value in degree, press **F4** to select the unit. The phase deviation range is 0 - 360°.

To Set the System

Language Setting

Press **Utility** and choose **System**, press **F1** to switch display languages.

Power On Setting

- (1) Press **Utility** and choose **System**, press **F2** to select **Power On**.
- (2) Press **F2** to switch between **Default/Last**. **Default** means that all the settings return to default when powered. **Last** means that all the settings return to the last one when powered.

To Return to Default Setting

Press **Utility** and choose **System**, press **F3** to select **Set to Default**, press **F1** to confirm. All the settings will be set to default. The default settings of the system are as follows:

Output	Default
Function	Sine Wave
Frequency	1 kHz
Amplitude/Offset	1 V _{p-p} / 0 Vdc

Waveforms	Default
Frequency	1 kHz
Amplitude	1 V _{p-p}
Offset	0 Vdc
Duty Cycle of Square	50%
Symmetry of Ramp	50%

5.Front Panel Operation

Pulse Width of Pulse	200 us
Duty Cycle of Pulse	20%

Modulation	Default
Carrier	1 kHz Sine Wave
Modulating	100 Hz Sine Wave
AM Depth	100%
FM Deviation	100 Hz
PM Phase Deviation	0°
FSK Hop Frequency	100 Hz
FSK Frequency	100 Hz
Source	Internal

Sweep	Default
Start/Stop Frequency	100 Hz/1 kHz
Time	1 sec
Mode	Linear

Burst	Default
Frequency	1 kHz
Count	1 Cycle
Period	1 sec
Phase	0°

Others	Default
Brightness	95%
Separator	Comma
Screen Saver time	100 minutes
Load	High Z
Phase Deviation	0°
Clock Source	Internal
Channel Output Control	Off

To Set the Beep

- (1) Press **Utility** and choose **System**, enter the second page of the menu.
- (2) Press **F1** to select **Beep**.
- (3) Press **F1** to switch between **On/Off**. On is to activate the sound when the system informs you. Off is to deactivate it.

View System Information

- (1) Press **Utility** and choose **System**, enter the second page of the menu.
- (2) Press **F2** to select **Sys info**. You can view the Version and Serial number.

To Set the Clock Source

The waveform generator provides an internal clock source and also accepts external clock source input from the **[Ref Clk/Counter In]** connector at the rear panel. It can also output a clock source from the **[Ref Clk Out]** connector for other device to use.

Note:

The amplitude of the **[Ref Clk/Counter In]** input signal must be over 1 V.

- (1) Press **Utility** and choose **System**, enter the second page of the menu.
- (2) Press **F3** to select **CLK Sou**.
- (3) Press **F3** to switch between **Internal/External**.

To Use Built-in Help

- (1) Press **Help** function button, the catalog will display in the screen.
- (2) Press **F1** or **F2** to choose help topic, or just turn the **knob** to choose.
- (3) Press **F3** to view the details about the topic; press **F5** to go back to the catalog.
- (4) Press **Help** again to exit the help, or just do other operations.

6. Communication with PC

The Waveform Generator supports communications with a PC through USB port. You can use the ultrawave communication software to set the parameters, control the output of the Waveform Generator.

The Waveform Generator supports communications with a PC by **SCPI commands** through USB port.

Here is how to connect with PC. Install the ultrawave communication software on the supplied CD.

- (1) **Connection:** Use a USB data cable to connect the **USB (type B) connector** on the rear panel of the Waveform Generator to the USB port of a PC.
- (2) **Install the driver:** When the Waveform Generator is turned on, a dialog will appear on the PC screen and guide you to install the USB driver. The driver is in the "USBDRV" folder under the directory where the ultrawave communication software is installed, such as "C:\Program Files\OWON\ultrawave\USBDRV".
- (3) **Port setting of the software:** Run the ultrawave software; click "Communications" in the menu bar, choose "Ports-Settings", in the setting dialog, choose "Connect using" as "USB". After connect successfully, the connection information in the bottom right corner of the software will turn green.

For the detail communication protocol of SCPI, please refer to *AG Series Waveform Generator SCPI Protocol*.

To learn about how to operate the software, press F1 in the software to open the help document.

7. SCPI

The waveform generator supports SCPI, and the users can operate and control the device by USB port. For the detailed information about SCPI, please refer to *AG Series Waveform Generator SCPI Protocol*.

8. Troubleshooting

1. The instrument is powered on but no Display.

- Check if the power is connected properly.
- Check if the Power Switch is in the proper voltage scale.
- Check if the fuse which is below the AC Power socket is used appropriately and in good condition (the cover can be pried open with a straight screwdriver).
- Restart the instrument after the steps above.
- If the problem still exists, please contact **Lilliput** for our service.

2. The measured value of output signal amplitude disaccords to the displayed value:

Check if the actual load matches the set one. Please refer to *To Set the Output Load* on page 35.

If you encounter other problems, try to reset the settings (refer to *To Return to Default Setting* on page 36) or restart the instrument. If it still can not work properly, please contact **Lilliput** for our service.

9. Technical Specifications

All these specifications apply to the Waveform Generator unless otherwise explanation. To reach these specifications, the instrument must have been operating continuously for more than 30 minutes within the specified operating temperature.

All the specifications are guaranteed unless those marked with “typical”.

Waveforms	
Standard Waveforms	Sine, Square, Ramp, Pulse, Noise
Arbitrary Waveforms	Exponential rise, Exponential fall, Sin(x)/x, Staircase etc. 45 built-in waveforms, User-Definable Waveform
Numbers of channel	2

Frequency Characteristic		
Frequency resolution: 1 μ Hz		
AG1012F,AG1022F Max sampling rate 125 MSa/s, AG2052F ,AG2062F Max sampling rate 250 MSa/s		
Sine	AG1012F	1 μ Hz—10 MHz
	AG1022F	1 μ Hz—25 MHz
	AG2052F	1 μ Hz—50 MHz
	AG2062F	1 μ Hz—60 MHz
Square	AG1012F	1 μ Hz—5 MHz
	AG1022F	
	AG2052F	1 μ Hz—25 MHz
	AG2062F	1 μ Hz—30 MHz
Ramp	1 μ Hz—1MHz	
Pulse	AG1012F	1 μ Hz—5 MHz
	AG1022F	
	AG2052F	1 μ Hz—10 MHz
	AG2062F	1 μ Hz—15 MHz
White Noise	25 MHz bandwidth (-3 dB) (typical)	
Arbitrary	1 μ Hz—10 MHz	

Amplitude Characteristic		
Output Amplitude	High Z	1 μ Hz to 10 MHz: 1 mVPP-20 VPP 10 MHz to 25 MHz: 1 mVPP-10 VPP
	50 Ω	1 μ Hz to 10 MHz: 0.5 mVPP-10 VPP 10 MHz to 25 MHz: 0.5 mVPP-5 VPP
Amplitude Accuracy	1 mVPP or 14 bits	
DC Offset Range (AC+DC)	\pm 5 V (50 Ω) \pm 10 V (High Z)	
DC Offset Accuracy	1 mV	
Output Impedance	50 Ω (typical)	

9. Technical Specifications

Waveform Characteristic		
Sine		
Flatness (when the Amplitude is 1.0 V _{p-p} (+4 dBm), relative to 1 kHz)	AG1012F AG1022F	1 μHz to 10 MHz: 0.2 dB ± 1 mv 10 MHz to 25 MHz: 0.3 dB ± 1 mv
	AG2052F AG2062F	1 μHz to 10 MHz: 0.2 dB ± 1 mv 10 MHz to 25 MHz: 0.3 dB ± 1 mv 25 MHz to 50 MHz: 0.5 dB ± 1 mv
Harmonic Distortion (when the Amplitude is 1.0 V _{p-p})	AG1012F AG1022F AG2052F AG2062F	<-40 dBc
Total Harmonic Distortion (when the Amplitude is 1 V _{p-p})	10 Hz to 20 kHz: <0.2 %	
Phase Noise (when the Amplitude is 1 V _{p-p})	-110 dBc/Hz	
Residue Clock Noise	-57 dBm (typical)	
Square		
Rise/Fall Time	<12 ns (10% - 90%) (typical, 1 kHz, 1 V _{p-p})	
Jitter (rms)	AG1012F AG1022F	1 ns + 30 ppm
	AG2052F AG2062F	300 ps + 100 ppm of period
Non-symmetry (below 50% Duty Cycle)	1% of period+ 5 ns	
Overshoot	< 5%	
Duty Cycle	AG1012F	20% - 80% (< 1 MHz)
	AG1022F	50% (1 MHz - 5 MHz)
	AG2052F	20% - 80% (< 10 MHz)
	AG2062F	50% (> 10 MHz)
Ramp		
Linearity	< 0.1% of peak output (typical, 1 kHz, 1 V _{p-p} , Symmetry 50%)	
Symmetry	0% to 100%	
Pulse		
Pulse Width	AG1012F AG1022F	40 ns to 1000 ks
	AG2052F AG2062F	20 ns to 1000 ks

9. Technical Specifications

Accuracy	10 ns	
Rising/Falling Edge Time	< 12 ns	
Overshoot	< 5%	
Jitter	AG1012F AG1022F	1 ns + 30 ppm
	AG2052F AG2062F	300 ps + 100 ppm of period
Arbitrary		
Waveform Length	AG1012F AG1022F	2 – 8k points
	AG2052F AG2062F	2 - 1M points
Sample Rate	AG1012F AG1022F	125 MSa/s
	AG2052F AG2062F	250 MSa/s
Amplitude Accuracy	14 bits	
Minimum Rise/Fall Time	35 ns (typical)	
Jitter (RMS)	6 ns + 30 ppm	

Modulated Waveform

AM

Carrier Waveforms	Sine
Source	Internal/ External
Internal Modulating Waveforms	Sine, Square, Ramp, White Noise, Arbitrary
Internal AM Frequency	2 mHz - 20 kHz
Depth	0.0% - 100.0%

FM

Carrier Waveforms	Sine
Source	Internal/ External
Internal Modulating Waveforms	Sine, Square, Ramp, White Noise, Arbitrary
Internal Modulating Frequency	2 mHz - 20 kHz
Frequency Deviation	2 mHz - 20 MHz

PM

Carrier Waveforms	Sine
Source	Internal/ External
Internal Modulating Waveforms	Sine, Square, Ramp, White Noise, Arbitrary
Internal PM Frequency	2 mHz - 20 kHz
Phase Deviation	0° - 180°

FSK

Carrier Waveforms	Sine
Source	Internal/ External
Internal Modulating Waveforms	50% duty cycle square

9. Technical Specifications

FSK Rate	2 mHz - 100 kHz	
PWM (only in AG2052F and AG2062F)		
Carrier Waveforms	Pulse	
Source	Internal/ External	
Internal Modulating Waveforms	Sine, Square, Ramp, Arbitrary	
Internal Modulating Frequency	2 mHz - 20 kHz	
Width Deviation	Pulse width 0.0 ns to 200.00 usec	
Sweep		
Type	Linear, Logarithmic	
Carrier Waveforms	Sine, Square, Ramp	
Direction	Up / Down	
Sweep Time	1 ms to 500 s \pm 0.1%	
Source	Source, External or Manual	
Burst		
Waveforms	Sine, Square, Ramp, Pulse, Arbitrary	
Types	Count (1 to 1,000,000 periods), infinite, gated	
Start Phase	-360° - +360°	
Internal Period	(10 ms - 500 s) \pm 1%	
Gated Source	External Trigger	
Trigger Sources	Source, External or Manual	
Counter Specification		
Function	Frequency, period, positive Pulse width, Duty cycle	
Frequency Range	Single channel: 100 mHz - 200 MHz	
Frequency Resolution	6 digits	
Voltage Range and Sensitivity (non-modulation signal)		
DC coupled	DC offset range	\pm 1.5 VDC
	100 mHz - 100 MHz	250 mV _{p-p} - 5 V _{p-p} (AC+DC)
	100 MHz - 200 MHz	450 mV _{p-p} - 3 V _{p-p} (AC+DC)
AC coupled	1 Hz - 100 MHz	250 mV _{p-p} - 5 V _{p-p}
	100 MHz - 200 MHz	450 mV _{p-p} - 4 V _{p-p}
Pulse width and Duty cycle Measure	1 Hz - 10 MHz (100 m V _{p-p} - 10 V _{p-p})	
Input adjust	Input impedance	1 M Ω
	Coupling mode	AC, DC
	High frequency restrain	High frequency noise restrain (HFR) On or Off
	sensitivity	Low, Middle, High
Trigger level range	\pm 2.5 V	
Input/Output		
Channel Coupling, Channel Copy		
Phase Deviation	0 - 360°	
Rear Panel		

9. Technical Specifications

Interfaces	USB (type B) connector	
External Modulation Input		
Input Frequency Range	DC-20 kHz	
Input Voltage Range	± 5 Vpk	
Input Impedance	10 k Ω (typical)	
External Trigger Input		
Level	TTL-compatible	
Slope	Rising or falling (selectable)	
Pulse Width	>100 ns	
Trigger Delay	0.0 ns - 60 s	
External Reference Clock Input		
Impedance	1 k Ω , AC coupled	
Requested Input voltage swing	100 mV _{p-p} to 5 V _{p-p}	
locking range	20 MHz \pm 35 kHz	
Counter Input (share the same port as External Reference Clock Input)		
DC coupled	DC offset range	± 1.5 VDC
	100 mHz - 100 MHz	250 mV _{p-p} - 5 V _{p-p} (AC+DC)
	100 MHz - 200 MHz	450 mV _{p-p} - 3 V _{p-p} (AC+DC)
AC coupled	1 Hz - 100 MHz	250 mV _{p-p} - 5 V _{p-p}
	100 MHz - 200 MHz	450 mV _{p-p} - 4 V _{p-p}
External Reference Clock Output		
Impedance	50 k Ω , AC coupled	
Amplitude	5 V _{p-p} , access 50 Ω	

Display

Display Type	3.9 inch colored LCD (Liquid Crystal Display)
Display Resolution	480 (Horizontal) \times 320 (Vertical) Pixels
Display Colors	65536 colors, 16 bits, TFT screen

Power

Supply	220-230 VAC, 100-110 VAC, 50/60 Hz, CAT II	
Consumption	Less than 18 W	
Fuse	110 V	125 V, F4AL
	220 V	250 V, F2AL

Environment

Temperature	Working temperature: 0 $^{\circ}$ C - 40 $^{\circ}$ C Storage temperature: -20 $^{\circ}$ C - 60 $^{\circ}$ C
Relative Humidity	$\leq 90\%$
Height	Operating: 3,000 m Non-operating: 15,000 m
Cooling Method	Natural cooling

Mechanical Specifications

9. Technical Specifications

Dimension	235 mm × 110 mm × 295 mm (W*H*D)
Weight	3 kg

Interval Period of Adjustment:

One year is recommended for the calibration interval period.

10. Appendix

Appendix A: Enclosure

Standard Accessories:

- A power cord that fits the standard of the destination country
- A USB cable
- A CD (PC link application software)
- A Quick Guide
- A BNC/Q9 cable

Appendix B: General Care and Cleaning

General Care

Do not store or leave the instrument where the liquid crystal display will be exposed to direct sunlight for long periods of time.

Caution: To avoid any damage to the instrument, do not exposed it to any sprays, liquids, or solvents.

Cleaning

Inspect the instrument as often as operating conditions require.

To clean the instrument exterior, perform the following steps:

1. Wipe the dust from the instrument surface with a soft cloth. Do not make any scuffing on the transparent LCD protection screen when clean the LCD screen.
2. Disconnect power before cleaning your instrument. Clean the instrument with a wet soft cloth not dripping water. It is recommended to scrub with soft detergent or fresh water. To avoid damage to the instrument, do not use any corrosive chemical cleaning agent.



Warning: Before power on again for operation, it is required to confirm that the instrument has already been dried completely, avoiding any electrical short circuit or bodily injury resulting form the moisture.
